

TRAFFIC CONTROL MANUAL



Department of Transportation & Works



www.gov.nl.ca

Revised August 2018

FORWARD

This manual has been developed by the Department of Transportation and Works and is intended to provide safe and consistent methods of traffic control in work zones along roadways in the province of Newfoundland and Labrador. Any work occurring within the right-of-way of a roadway, shall conform to the minimum guidelines within this manual.

This manual takes effect April 1, 2019 and replaces all previous traffic control documents including the 1990 Traffic Control Manual for Roadway Work Operations, 1999 Traffic Control Manual for Roadway Work Operations, 2006 Traffic Control Manual for Roadway Work Operations, 2006 Traffic Control Manual for Maintenance Operations, 2011 Traffic Control Manual, 2013 Revised 2011 Traffic Control Manual. A summary of changes has been provided to aid users in identifying the revisions and new content provided in this latest edition of the Traffic Control Manual.

This manual is a living document and will continually be revised and updated with best practices to improve upon traffic control in work zones. It is therefore the sole responsibility of Manual users to check periodically to make sure they have the latest and legal edition of this manual.

ACKNOWLEDGEMENTS

This manual has been developed with the assistance of many groups and individuals including the following:

TCM Committee

Dion Tee, Transportation & Works NL
Barry Fitzgerald, Transportation & Works NL
Jim Thorne, Transportation & Works NL
Darryl Bruce, Transportation & Works NL
Christian Morris, Transportation & Works NL
Blair Bradbury, Transportation & Works NL
Fred Penney, Road Builder Member, Heavy Civil Association NL
Brad Piercey, Road Builder Member, Heavy Civil Association NL

Transportation & Works Operations Division

Christian Morris, Transportation & Works NL
Sean Pitts, Transportation & Works NL
Chris Hiscock, Transportation & Works NL
Barry Ellsworth, Transportation & Works NL

Typical Layouts

Robert Bragg, Transportation & Works NL
Heather Preston, Transportation & Works NL
Kim Reardon, Transportation & Works NL

Suggestions, comments and requests for changes or revisions and inquiries on the manual should be directed to:

Assistant Deputy Minister,
Operations Division
Highway Design, Construction & Operations Divisions
Department of Transportation and Works
P.O. Box 8700
St. John's, NL
A1B 4J6
709-729-2300

This manual can be viewed on the Department of Transportation & Works section of the Government of NL web site at www.tw.gov.nl.ca

TABLE OF CONTENTS	i
SUMMARY OF CHANGES	v
DEFINITIONS	vii
1.0 INTRODUCTION	1
1.1 Purpose	1
1.2 Fundamental Principles	1
2.0 TEMPORARY WORKPLACE COMPONENTS	4
2.1 Description of Advance Warning Area	4
2.2 Description of Approach Area	4
2.3 Description of Taper	4
2.4 Description of Buffer Zone	5
2.5 Description of Work Zone	5
2.6 Description of Termination Area	6
3.0 SPEED LIMITS	7
3.1 Construction Zone Speed Limits, General Information	7
3.2 Speed Signs	7
3.3 Guidelines for Speed Limits	8
4.0 SIGHT DISTANCES	9
4.1 Stopping Sight Distance	9
4.2 Intersection Sight Distance	9
5.0 TEMPORARY CONDITION SIGNS	11
5.1 Sign Specifications	11
5.2 Portable or Removable Sign Supports with Flags	12
5.3 Permanently Installed Temporary Condition Sign Supports	12
5.4 Mounting Chevron and Hazard Markers on Rebar for Installation on Paved Surfaces ..	12
5.5 Chevron and Hazard Markers used During the Winter Season	13
5.6 Intersecting Roads	13
5.7 Inactive Work Zones	13
6.0 TEMPORARY CONDITION DEVICES & DELINEATION	15
6.1 Application	15
6.2 Location of Delineation Devices	15
6.3 Spacing of Delineators	16
6.4 Construction Markers	16
6.5 Chevron Markers	17
6.6 Barricades	18

6.7 Light Barricade	19
6.8 Heavy Barricade	19
6.9 Traffic Cones.....	21
6.10 Delineator Posts	21
6.11 Drums	22
6.12 Barriers	22
6.13 Flashing Arrow Board	23
6.14 Attenuation Devices	25
6.15 Buffer Vehicle	25
6.16 Control Vehicle	26
6.17 Pilot Vehicles	26
6.18 Vehicle Strobe Lights	27
6.19 Portable Traffic Lights	28
6.20 Automatic Flagger Assistance Devices	28
6.21 Variable Message Signs	30
6.22 Radar Display Speed Signs	31
6.23 Temporary Conditions Pavement Markings	32
6.24 Temporary Rumble Strips.....	32
6.25 Miscellaneous	33
7.0 FLAGPERSON	34
7.1 Introduction	34
7.2 Flagperson Equipment	34
7.3 Flagperson Advance Sign	34
7.4 General Guidelines	34
7.5 Flagperson Requirements	36
7.6 Where to Stand	38
7.7 Flagging Signals	38
8.0 INCIDENT SIGNING	41
Incident Sign	42
Signing for Towing Operations	43
9.0 ZIPPER MERGE	44
10.0 TRAFFIC CONTROL DEVICES: INSTALLATION AND REMOVAL PROCEDURES	45
Two Lane Roadways	
Sign Setup	47
Work Zone Setup	48
Work Zone Removal	49
Sign Removal	50
Four Lane Divided Highway	

Sign Setup	51
Work Zone Setup	52
Work Zone Removal	53
Sign Removal	54
3 or 4 Lane Undivided Highway Right Lane or Shoulder	
Sign Setup	55
Work Zone Setup	56
Work Zone Removal	59
Sign Removal	62
3 or 4 Lane Undivided Highway Left Lane	
Sign Setup	63
Work Zone Setup	64
Work Zone Removal	67
Sign Removal	70
11.0 TYPICAL CONSTRUCTION SIGNS	71
12.0 TYPICAL CONTROL VEHICLE LAYOUTS	79
Control Vehicle Application	80
Very Short Term Work - Low Speed or Low Volume	81
Short Term Work - Low Speed or Low Volume	82
Snow Cleanup Operations – Two Way Traffic	83
Snow Cleanup Operations - Divided Highway	84
Moving Events	85
13.0 SIGN LAYOUT DIAGRAMS.....	86
13.1 Traffic Control Layout Selection	86
13.2 Decision Matrix and Typical Layouts	87
Typical Advance Work Area Signage.....	TCM LAYOUTS 740-1 to 740-4
Work Adjacent to Roadway.....	TCM LAYOUTS 750-1 to 750-9
Work at the Edge of the Roadway.....	TCM LAYOUTS 751-1 to 751-9
Lane Closed.....	TCM LAYOUTS 752-1 to 752-37
Successive Work Areas.....	TCM LAYOUT 753-1 to 753-2
Roadside Diversion.....	TCM LAYOUTS 754-1 to 754-3
Detour.....	TCM LAYOUTS 755-1 to 755-3
Intersecting Roads in Work Areas.....	TCM LAYOUTS 756-1 to 756-4
Positioning of Flagpersons.....	TCM LAYOUTS 757-1 to 757-2
Pavement Drop Off.....	TCM LAYOUT 758-1
Truck Entrance.....	TCM LAYOUT 759-1 to 759-1F
Temporary Striping Signing.....	TCM LAYOUT 770-1
Line Painting Procedures.....	TCM LAYOUTS 771-1 to 771-15
Grading Operations.....	TCM LAYOUT 775-1
Road Closed Barricade.....	TCM LAYOUTS 776-1 to 776-2

Survey Crew Signing.....TCM LAYOUTS 780-1 to 780-3
Portable Sign Supports.....TCM LAYOUT 790-1
Timing of Portable Traffic Lights.....TCM LAYOUT 791-1
Automated Flagging Assistance Devices.....TCM LAYOUT 792-1 to 792-4
Zipper Merge.....TCM LAYOUT 793

CONSTRUCTION DISTANCE TABLE TCM LAYOUT 799-1

LEGEND.....TCM LAYOUT 799-2

APPENDIX 1.....EMERGENCY TRAFFIC MANAGEMENT

APPENDIX 2.....HAZARD ASSESSMENT PROCESS

APPENDIX 3.....SAND BARREL ATTENUATION SYSTEM

APPENDIX 4.....STANDARD BARRIERS FOR ROAD AND BRIDGE CLOSURES

APPENDIX 5.....NIGHT TIME OPERATIONS

APPENDIX 6.....DECISION MATRIX

SUMMARY OF CHANGES

The following changes/revisions reflect the input of stakeholders who have recommended improvements in the development of the current 8th Edition of the Traffic Control Manual:

- The manual cover has been changed to make it recognizable as a new revision. Other associated changes to the “Forward” Section and Headers and Footers to indicate the new revised edition.
- The Table of Contents is revised to indicate the new layout, additional sections and 4 appendices.
- The Definitions section has been expanded to add several new definitions including the following: AADT, AASHTO, Attenuator, Barricade, Barrier, Delineation Devices, Detour, Diversion, Errant Vehicle, Flashing Arrow Board (FAB), Lane Closure, MASH, Mobile or Moving Operations, NCHRP, Night Work, Partial Lane Closure, Professional Engineer, Radar Speed Display Sign, Roadside Work, Roll-up Sign, Shoulder Work, TAC, Termination Area, Traffic Control Device, Traffic Control Person (TCP), Truck Mounted Attenuator (TMA), Variable Message Sign, Very Short Term Work, Work Vehicle.
- The definition for Very Short Term Work has been revised/expanded to cover situations other than low speed and low volume.
- Clarification on “12 consecutive hours” has been added in definition of Short Term or Short Duration work.
- Section 3.1, Construction Zone Speed Limits – General Information, has been revised to include posting of an advisory speed for local conditions where the roadway does not warrant a reduced speed limit.
- Section 6.0 has been renamed to “Temporary Condition Devices and Delineation” to better reflect the contents of the Section and to be consistent with other TCMs and the National Guideline, the Manual of Uniform Traffic Control Devices for Canada (MUTCD-C).
- Section 5.1, Sign Specifications, has been expanded to inform/clarify that sign locations may be adjusted in the field when the location on the plan creates an issue such as access blockage or visibility concerns.
- Section 5.7, Inactive Work Zones, has been added to provide guidance on the state in which a work zone is to be left when construction activities are finished for a period of time.
- Section 6.12, Barriers, has been added to provide guidance on their use.

- Section 6.14, Attenuators, has been added to provide information on the types of devices and TCM Layouts requiring truck mounted or trailer type impact attenuators.
- Section 6.17, Buffer Vehicle, has been added to provide guidance on their use.
- Section 6.20, Automated Flagging Assistance Devices (AFADs), has been added to provide information and guidance on the use of these devices in TCM Layouts.
- Section 6.22, Radar Display Speed Signs, has been added to provide information on their use and operation.
- Section 6.24, Temporary Rumble Strips, has been added to provide information and guidance on the use of these devices in TCM Layouts.
- Section 7.0, Flagperson, has been revised to provide clarification on the position and location of the Flagperson.
- Section 8.0, Incident Signing, has been revised to indicate additional information in Appendix 1 and a revise sign colour to Fluorescent Pink sheeting to be consistent with other Provinces and the National Guideline, the revised Manual of Uniform Traffic Control Devices for Canada (MUTCD-C) and US practice.
- Section 9.0, Zipper Merge, has been added to provide information on how to implement the layout into Work Zones.
- Section 11.0, Typical Construction Signs, has been expanded to include additional and new signs used in the provided layouts.
- Section 12.0, Typical Control Vehicle Layouts, adjustments have been made to the layouts to allow Crash Attenuators in the setup.
- All TCM layouts have been revised to remove the sign indicating “Fines Doubled in Construction Zones Maximum Fine \$1500”. This sign was a promotional sign when the “Doubled Fines” initiative was first introduced. This sign is not required by legislation to enforce double fines in construction zones. This message is delivered by sign TC-CZ1 “Construction Zone Begins Maximum Fine \$1500” which is present as the final sign before entering the construction zone.
- TCM Layouts 740-1 to 740-4 have been created to replace previous Layouts 760-1 and 760-2 to provide clarity on project signage, Advance Warning Signage and Approach Signage for construction and maintenance projects.

- TCM Layouts 752-30 to 752-37 have been added for use on Multi-lane highways with impact attenuators for Moving Operations, Very Short Term and Short Term Work.
- TCM Layouts 756-3 and 756-4 have an additional note added to cover flagperson requirements when traffic lights present.
- Appendix 1 has been added for signing of incident and emergency operations. This appendix is consistent with other province's TCMs and separate publications in other provinces for Traffic Management in Emergency Operations.
- Appendix 2 has been added to present the Department's process for Hazard Assessment so that it may be adopted for use or modified for use by others.
- Appendix 3 has been added to present Sand Barrel Attenuation Systems.
- Appendix 4 has been added to present Standard Barriers for Road and Bridge Closures.
- Guidelines for Night time operations has been added in Appendix 5 with standards for illumination of the work area during darkness.
- A new decision matrix has been developed to provide better guidance in selecting the appropriate figure for the work zone conditions. This matrix may be found in Section 13.2 and in Appendix 6.

DEFINITIONS

AADT: Average Annual Daily Traffic expressed in terms of vehicles per day. A full year of traffic divided by 365 days or the statistical equivalent based on partial corrected measurements.

AASHTO: designation of the American Association of State Highway and Transportation Officials.

Advance Warning Area: the section of roadway where motorists are first alerted to upcoming road work. This area may begin up to 2km ahead of the **approach area** and end at the TC-1 Construction Ahead sign.

Approach Area: the approach area is the section of the roadway where motorists are given final warning of what actions are required to be taken before entering the work zone.

Attenuator: an energy absorbing device, either mounted directly on the rear of a vehicle or mounted on a trailer behind a vehicle. Attenuators are rated based on their ability to absorb impacts from vehicles at various speeds.

Automatic Flagger Assistance Device: a device that features a circular red lens, a circular yellow lens and a gate arm. The device is considered an extension of the flagperson's arm and is used to stop/control the flow of traffic. This device is not considered as a portable traffic signal.

Barricade: a device which provides a visual indicator of a lane or road closure.

Barrier: a device, or a series of devices, which a vehicle would not normally pass through, which is intended to prevent errant vehicles from entering a work area or closed road area.

Buffer Vehicle: a vehicle with an attached attenuation device placed in advance of a work zone and used to provide protection to workers from errant vehicles.

Buffer Zone: the space reserved in the work area, from the last approach sign to the taper or work zone.

Construction Speed Limit: the regulatory speed limit posted in a construction zone.

Construction Zone: a temporary workplace where double fines may be applied.

Control Vehicle: a vehicle to support traffic control in sign and work zone layout and removal operations.

Dedicated Traffic Observer: an individual whose sole responsibility is to monitor approaching traffic and warn workers of potential hazards.

Delineation Devices: devices used to highlight the intended traffic path through a construction zone.

Detour: route traffic must take to depart completely from the original road and follow another road to bypass a work area.

Diversion: the path traffic must deviate from its normal path to bypass a work area.

Double Posting: the practice of placing signs on both sides of the roadway.

Engineering Judgment: The evaluation of available pertinent information and the application of appropriate engineering principles, provisions, and practices for the purpose of deciding on the applicability, design, operation or installation of a traffic control device.

Errant Vehicle: a vehicle that strays from its designated path and travels in an uncontrolled or unpredictable manner.

Flashing Arrow Board (FAB): an electronic sign with a group of lights capable of displaying directional arrows (arrow mode) or a horizontal line or bar (bar mode).

Intersecting Roads: public roadways that intersect the road within the work area. These intersecting roads shall only be considered public roadways if they exceed 1km in length and access a minimum of ten residential dwellings, or exceed 300m in length and access a business which generates hourly traffic volumes exceeding 25 vehicles per hour.

Lane Closure: reduction of a usable travelled lane width to less than 2.5 meters in order to facilitate work in the travel lane of the roadway.

Lane Control: the practice of using a sign, traffic light or flagperson to control or stop traffic.

Long Term or Long Duration Work: work that occurs in a fixed location for a period exceeding 12 consecutive hours.

Low Traffic Volume: traffic volume on a road with less than 20 vehicles in 3 minutes

MASH: the Manual for Assessing Safety Hardware administered by the American Association of State Highway and Transportation Officials, **AASHTO**.

Mobile or Moving Operations: work that is either done continuously, usually at low speeds, or intermittently, with brief stops related to the work.

MUTCD: Manual of Uniform Traffic Control Devices for Canada

NCHRP: designation of the National Highway Cooperative Research Program of the Transportation Research Board (TRB) of the US Department of Transportation.

Night Time Operations: work performed from a half hour after sunset to half hour before sunrise.

Professional Engineer: a person who holds a certificate of registration to engage in the practice of engineering under the *Engineers and Geoscientists Act, NL*.

Partial Lane Closure: reduction of the usable travelled lane width to a minimum of 3.0 meters when work is carried out in the travelled lane.

Pilot Vehicle: a vehicle used to escort road users through a work zone that may be long or complex to navigate.

Qualified: being knowledgeable of the work, the hazards involved and the means to control the hazards, by reason of education, training, experience or a combination of them.

Radar Display Sign: a special type of **Variable Message Sign (VMS)** equipped with a radar unit which displays an approaching vehicles speed to the driver. The device may also contain a data logger for analysis of recorded data.

Regulatory Speed Limit: as defined by Manual of Uniform Traffic Control Devices for Canada (MUTCD) this is the speed limit that applies at a specific time or place on a road. This is the maximum legal limit under ideal driving conditions on the section of road identified by the signs.

Roadside Work: work carried out within 15 meters of the travelled lanes, but outside the shoulder area. (includes paved and gravel shoulders).

Roll-up Sign: A portable temporary condition warning sign of a roll-up design having a fabric substrate with a reflectorized face.

Service Vehicle: a vehicle to support a project by transporting workers and/or equipment but not used to perform a primary work function; may be used to assist sign and device placement.

Sign Layout Diagram: A diagram covering typical sign layout for a particular roadwork activity. These diagrams are developed from national guidelines and adjacent regional road authorities and usually suggest minimum requirements to be considered.

Slow Moving Operation or Mobile Operations: work that is performed while moving continuously, usually at low speed, and is sometimes stationary for periods not exceeding 30 minutes. This includes inspection operations and maintenance operations such as crack sealing and line painting. Sporting or charitable activities where groups or individuals travel between points along provincial highways may be considered for this type of operation. This operation applies where traffic volume is light and visibility is good. When traffic volume and speed is higher a

Control Vehicle should follow this operation to act as an advance warning of the operations ahead. See **Control Vehicle** description and diagram.

Snow Cleanup Operations: the pushing back of snow from a roadway that has been opened to traffic. This typically involves equipment that may have to operate perpendicular to traffic flow and may have to cross one or more lanes of traffic.

Short Term or Short Duration Work (low speed or low volume): work that occurs in a fixed location for a period exceeding 30 minutes, but less than 12 consecutive hours. At the end of the day the roadway is returned to normal operating conditions. The normal posted speed limit is less than 70km/h or traffic volumes are normally less than 500 vehicles per day. Consideration should be given to not performing work of this nature during peak traffic hours.

Short Term or Short Duration Work (high speed or high volume): work that occurs in a fixed location for a period exceeding 30 minutes, but less than 12 consecutive hours. At the end of the day the roadway is returned to normal operating conditions. The normal posted speed limit is 70km/h or higher or traffic volumes are normally more than 500 vehicles per day. Sign Requirements will be as per typical associated drawings. Consideration should be given to not performing work of this nature during peak traffic hours.

Shoulder Work: work which is carried out on the shoulder area of a road, but does not encroach on the travelled lanes of the roadway.

Successive Work Areas: a work area within a minimum of 500 meters to a maximum of 2km from an initial work area which may be signed with a reduced amount of signage because of its proximity to the initial work area encountered on a roadway.

Support Vehicle: a vehicle to support a maintenance operation by transporting workers and/or equipment but not used to perform a primary work function; may be used to assist sign and device placement. (usually found in line painting operations)

TAC: the Transportation Association of Canada

Taper: the area provided immediately ahead of the work zone, which provides a gradual narrowing of a traffic lane, using various traffic control delineators or devices.

Temporary rumble strips: portable rubber devices placed across a roadway perpendicular to the direction of traffic flow. These devices are used to alert drivers to surrounding conditions through noise and vibration.

Termination Area: the component of a work area where traffic may return to its normal path and driving conditions.

Traffic Control Device: includes Signs, Flashing Arrow Boards (FAB), Barriers, Barricades, Delineation Devices, Pavement Markings, or Vehicles used to control traffic, typically in reference to highway maintenance and construction activity in this manual.

Traffic Control Plan: a plan prepared in advance of commencing work that addresses all aspects of traffic control in the **Work Area**.

Traffic Control Person (TCP): a person qualified and accredited to direct traffic movement and prevent conflicts between vehicles and in road activities such as road maintenance, construction, road incidents and emergency operations.

Traffic Professional: A traffic professional is a person who has been trained in the principles and practices of traffic control and who, by successful completion of the approved training programs, is accredited. Traffic professionals are designated by their employers to fulfil the employer's legal obligations for compliance with the Traffic Control Manual, at their sites. Traffic professionals must carry their accreditation certificate while they perform their duties. The traffic professional position is one of great authority and responsibility at a temporary workplace. Those chosen and designated by employers are typically at the supervisory level. They have authority over personnel and have access to the physical and financial resources needed to ensure workplaces are in compliance with provincial standards. Where traffic control safety issues impact a workplace, traffic professionals act immediately and decisively to ensure everyone's safety (this may include shutting down a workplace).

Truck Mounted Attenuator (TMA): an energy absorbing device which may be mounted on the rear of a large vehicle or towed on a trailer behind a vehicle which protects workers ahead of the attenuation device while in the roadway. Attenuators are rated based on their ability to absorb impacts from vehicles at various speeds. Users of these devices must ensure the attenuators are suitable for the application by the certification of the device through **NCHRP** or **MASH** standards for the conditions of the work area.

Variable Message Sign (VMS): an electronic sign capable of displaying a message or a number of sequential messages to provide information to road users of ongoing or planned road work.

Very Short Term or Very Short Duration Work with low speed or low volume: work that occurs in a fixed location for a period not exceeding 30 minutes, including the time required to setup and remove traffic control devices. The normal posted speed limit is less than 70km/h or traffic volumes are normally less than 500 vehicles per day. Consideration should be given to not performing work of this nature during peak traffic hours.

Very Short Term Work: work that occurs in a fixed location for a period not exceeding 30 minutes, including the time required to setup and remove traffic control devices.

Work Area: the entire length of the roadway that is affected by any construction, maintenance or utility work, from the first advance warning sign to the point where the roadway is restored to normal operating condition.

Work Vehicle: Any vehicle, as defined under the OH&S Regulations, used to facilitate maintenance, construction, emergency or utility work on a roadway.

Work Zone: the portion of the work area where the actual construction, maintenance or utility work occurs.

1.0 INTRODUCTION

1.1 PURPOSE

The purpose of this manual is to assist users with uniform and consistent methods for installing traffic control devices, thus ensuring safety and minimizing inconvenience to both motorists and workers while completing work activities. Diagrams are provided for most common traffic control scenarios encountered, however this manual cannot possibly cover all scenarios that may occur. It is incumbent on the user of this manual to develop an appropriate traffic control plan using this manual as a guide along with sound technical judgment. For unique situations, those preparing a traffic control plan may contact the Department of Transportation for advice, however ultimate responsibility lies with the user to ensure that the traffic control plan complies with the regulations. A suitably qualified and competent Professional Engineer is required to certify changes to Traffic Control Plans and Sign Layout Diagrams presented in this manual. (Reference 2012 OHS Regulations 373 to 375)

It is the responsibility of those working on provincial roadways to ensure that the principles and procedures contained within this manual are applied. Where a municipality has developed their own traffic control procedures and been granted approval by the Minister representing Occupational Health and Safety (OHS Regulation 373(3), those established procedures may be used as an alternative to this manual for locations within the municipality.

The appropriate level of traffic control for a situation shall be determined using the guidelines provided and sound technical judgment based upon a review of the work site and local traffic conditions. The decision to use a particular traffic device at a specific location must consider all local conditions. This manual, and other guidelines available, provide the basis for selecting a traffic control plan, however it is not a substitute for sound technical judgment. Safety should not be compromised in the selection of a traffic control plan. If a variation from the typical layouts provided is considered, the traffic control plan should be approved by a suitable qualified competent professional engineer prior to implementation. The typical traffic control layout diagrams presented in this manual can be used for all types of work, including all maintenance activities.

1.2 FUNDAMENTAL PRINCIPLES

1. All traffic control signs and devices used for temporary conditions are designed and installed for the safety and convenience of the traveling public and for the safety of the workers.
2. Work sites shall be carefully checked to make sure that traffic controls are changed to suit changing construction conditions due to work staging and progress, or if an immediate improvement to the traffic control is needed. Any problems shall be dealt with immediately and documented.

3. All signs shall conform to the required standards in shape, color, size and position as outlined by this Traffic Control Manual and the Manual of Uniformed Traffic Control Devices for Canada.
4. Throughout the normal construction season, including weekends and overnight, all temporary condition signage shall be securely installed on either portable sign supports or permanently installed sign supports. During periods of inactivity in a construction zone, if signs are not maintained, they may be required to be installed on permanent sign supports. When portable sign supports are used, they shall be vertically adjustable such that signs will be displayed at the minimum required height. If this cannot be achieved, flags shall be added to the top of the sign supports to meet the minimum required height as per drawing # 790-1. The base of the sign supports shall not be appreciably wider than the signs. Bases which require weighting for support shall be weighted using sandbags only. The use of rocks, boulders, concrete blocks, etc, as weights shall not be permitted. When signs are removed from the construction zone, the sandbags must also be removed and not left along the shoulder of the highway. Where portable sign supports are poorly maintained or unable to provide constant uninterrupted support for temporary condition signage, the contractor shall be required to install permanent sign supports.
5. Poorly maintained, defaced, damaged, or dirty temporary condition signs are ineffective and shall be replaced, repaired, or cleaned without delay. Signs which have been defaced or damaged and are not replaced within 24 hours of notification shall be expropriated by the Department. All signage expropriated in this manner will remain the property of the Department of Transportation and Works. Any work or costs associated with sign removal, sign replacement or traffic control will be the responsibility of the contractor.
6. No work will be permitted to commence until all traffic control devices are installed in position, as shown in this manual and approved by the user's qualified technical representative.
7. After a work zone is completed all traffic signs used on that construction zone shall be removed immediately. Any installed signs not applicable during a phase of construction shall be removed or covered. The Department reserves the right to expropriate all temporary condition signs that are left in place after the work zone is completed. In particular the Department especially focuses upon unwarranted and misused speed limit signage and flag person signage. All signage and associated hardware will remain the property of the Department of Transportation and Works.
8. Objects within the roadway or immediately adjacent to the roadway, which constitute a hazard to traffic shall be marked with a delineator device.
9. Construction Speed Zones shall be implemented only as shown on the applicable drawing. A hazard assessment shall be part of determining an appropriate speed limit

- in a construction zone. The Department representative shall be consulted prior to implementing a posted speed limit change on a provincial roadway.
10. After dark all signs shall be checked for visibility and those that cannot be clearly seen shall be cleaned, replaced or adjusted.
 11. Any signs not supplied by the Department of Transportation and Works shall meet all specifications in the Manual of Uniform Traffic Control Devices for Canada and the Traffic Control Manual.
 12. Sound technical judgment must be utilized in the application of the principles put forward in this Traffic Control Manual. Traffic plans within this manual requiring adjustment to local conditions must be reviewed and approved by a suitably competent and qualified Professional Engineer or other person named by the employer and acceptable to the assistant deputy minister representing Occupational Health and Safety. (Reference OHS Regulations 373 to 375 and other 2012 OHS Regulations). The location of all traffic control devices and operations shall be documented on a daily basis, including any changes made to adjust to current conditions. Work site conditions vary greatly from Traffic Control Manual layouts presented in this manual. It is up to the user, and the regulator, to adapt the principles of the manual to the given situation. The Traffic Control Manual layouts shall be considered minimum standards for required signage for the noted situations.
 13. In rare instances it may be acceptable for a worker to briefly enter a travelled lane with the aid of a Work Vehicle equipped with 4 way flashers and a warning light and a “Dedicated Traffic Observer” rather than a fleet of warning signs. Provided the worker can easily clear the lane when a vehicle approaches, this practice may be acceptable. An example of such an activity may include removing a small piece of debris from the roadway. If debris on a roadway poses an immediate safety threat to road users it may be removed with extreme caution considering the situation and current conditions, provided it only requires a momentary pause in the travelled lane.

2.0 TEMPORARY WORKPLACE COMPONENTS

2.1 DESCRIPTION OF ADVANCE WARNING AREA

The advance warning area is the section of the roadway where motorists are first alerted to roadwork ahead. Signing in this area may begin up to 2km from the approach area and ending at the TC-1 CONSTRUCTION AHEAD sign. See the diagram below and TCM Layout 740-1 to 740-4 for further explanation.

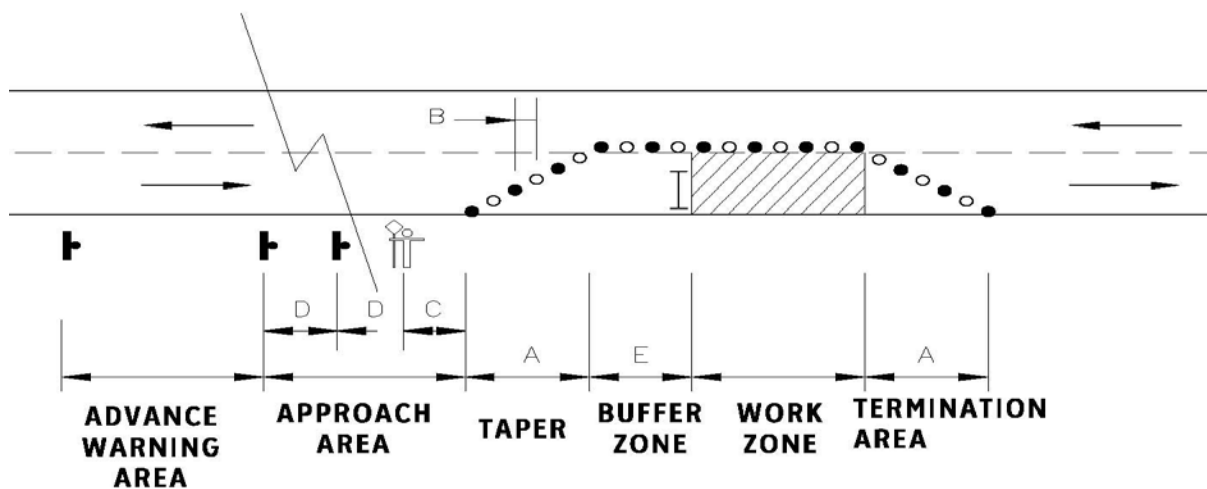

2.2 DESCRIPTION OF APPROACH AREA

The approach area is the section of the roadway where motorists are given final warning and information on what actions to take before entering the work zone. Signing in this area typically begins immediately following the TC-1 CONSTRUCTION AHEAD sign and ends at the beginning of the buffer zone.

2.3 DESCRIPTION OF TAPER

The taper or transition area is the section of the roadway where motorists are channelized from the normal alignment to proceed safely past the work zone. Depending on the location of the work a taper may not be required if there is no encroachment into the travelled portion of the roadway. The taper is normally delineated with the use of pylons, construction markers, chevrons, drums or delineator posts. The transition area may include several diagonal and parallel sections to safely route vehicles to bypass the work zone. The length of the taper sections are important to properly guide traffic, and are shown on each of the Sign Layout Diagrams and the Construction Distance Table 799-1.

The taper length is the length of the section of roadway required to achieve the rerouting from the normal travel path and shall be as follows when no lane control is present (based on the normal posted speed limit):

50 km/h or less	30 m
60 km/h	40 m
70 km/h	60 m
80 km/h	90 m
90 km/h	110 m
100 km/h	180 m

When lane control and low speed is present on the approach to the work zone, the taper may be reduced to 30 meters. Lane control would be in the form of a flagperson, temporary traffic control signal or lane controlling signage in low speed and low volume traffic areas. (See Sign Layout Diagrams 752-1 to 752-6).

2.4 DESCRIPTION OF BUFFER ZONE

The buffer zone provides a recovery area for errant vehicles by providing a clear zone between the taper/transition area and the work zone. The buffer zone is usually delineated by traffic devices and no work material, vehicles or equipment are stored/used in this area. When a Control Vehicle is placed in advance of the work zone, the buffer zone should be provided between the Control vehicle and the work zone. Buffer zone lengths are shown on each of the Sign Layout Diagrams and the Construction Distance Table 799-1.

2.5 DESCRIPTION OF WORK ZONE

The work zone is the portion of the roadway which contains the work activity (workers, equipment, and construction materials). The work zone may be fixed in one location or moved as the work progresses. The area is usually delineated by channelizing devices or in some instances shielded by barriers.

Potential hazards and conflicts will increase in the work area if:

- The work area is close to the travel lane(s);
- A physical obstruction exists (uneven pavement, trucks turning, etc.);
- Speed of traffic increases;
- The distance the traffic is shifted gets greater or more complex.
- The duration of the work increases (in excess of 12 hours)

The layouts found in this manual will illustrate the typical delineation and distance signs are to be installed in advance of a work zone.

2.6 DESCRIPTION OF TERMINATION AREA

The termination area is used to transition vehicles back to the normal travel lanes of the roadway after the work zone. The termination area extends from the end of the work zone to where normal vehicle operation can resume. This transition is normally similar to the taper leading into the work zone. The driver is informed of the end of the construction zone after leaving the termination area and can usually return to the original operating speed of the roadway upon leaving this area.

3.0 SPEED LIMITS

3.1 CONSTRUCTION ZONE SPEED LIMITS – GENERAL INFORMATION

Speed limits must reflect the road conditions in existence at the time. Signs must be removed or changed immediately when the condition changes. When the road condition does not warrant reduced speed during non-working periods, overnight, or weekends, the signs shall be removed or covered.

For situations where a roadway does not warrant a speed limit reduction, however a motorists may need to slow down for a localized condition, an advisory speed sign may be installed to inform motorists of a potential need to reduce speeds. Such instances would be situations such as paving operations that have finished however a low shoulder remains or where small milled or bumps are present prior to completing paving operations for a section of roadway.

On a divided highway, if construction involves only one side of the highway, the speed limit will be lowered in the affected direction of travel only and will remain unaltered in the opposite direction.

The reducing of a speed limit through the entire work project will not be permitted. Having each work zone individually considered, based on the general geometric conditions of the work zone, is the only acceptable method of speed limit signing.

All conflicting speed limit signs within the reduced speed zone shall be removed or covered while the temporary speed limit is in effect.

Double fines apply in construction zones. In order for the regulations to be enforced the speed limit and the beginning and end of the construction zone must be marked. Advanced warning signage of the double fine penalty is not always required but should be provided on long projects at the beginning of the project limit in the advance warning area (Sign TC-CZ3) and also on projects where the work will be long term on high speed and high volume roads.

3.2 SPEED SIGNS

All speed limits shall be signed using reflectorized maximum speed limit signs as specified in the Manual of Uniform Traffic Control Devices for Canada.

All speed limits indicated on these signs shall be in 10 km/h increments.

Maximum Speed Ahead signs are required where speed limit reductions of more than 10 km/h are present. When required these signs shall be placed 150 m to 250 m in advance of a construction speed sign.

Where the Maximum Speed Ahead sign is positioned in advance of normal temporary condition signage an advance “Construction Ahead” sign must be installed ahead of the speed ahead sign.

At the end of the construction zone, which has a reduced speed limit posted, a speed limit sign shall be posted indicating a return to the normal speed limit on that particular section of highway. This sign may be omitted if there exists a permanently installed speed limit sign within 300 m of the end of the reduced speed zone.

Reduced speed limit signs left in place when the work zone condition does not warrant any reduction may be expropriated by the Department of Transportation and Works.

3.3 GUIDELINES FOR SPEED LIMITS

The recommended speed limits shown in Table 717.04.01 are provided for geometrics only. Sound technical judgment must be used to adjust these speeds depending on the surface condition, the proximity and number of workers, equipment, and type of obstruction to the through traffic.

Table 717.04.01

Construction Zone Speed Limit	Sight Distance in Each Direction
90 km/h	280 m or greater
80 km/h	230 m – 279 m
70 km/h	200 m – 229 m
60 km/h	170 m – 199 m
50 km/h	140 m – 169 m
40 km/h	110 m – 139 m
30 km/h	less than 109 m

All posted speed limits on construction zones must have prior approval from the Department of Transportation and Works on provincial roadways.

4.0 SIGHT DISTANCES

4.1 STOPPING SIGHT DISTANCE

Stopping sight distance is defined by the Transportation Association of Canada (TAC) as the sum of the distance travelled by a vehicle during the perception and reaction time and the braking distance. The following table illustrates the minimum distance a vehicle needs in order to identify, react and safety stop for a hazard based on the posted speed of the roadway.

Design Speed (km/h)	Stopping Sight Distances (m) for Automobiles and Trucks
40	60 - 70
50	85 - 110
60	105 - 130
70	135 - 180
80	155 - 210
90	190 - 265
100	235 - 330

4.2 INTERSECTION SIGHT DISTANCE

Intersection sight distance is defined by the Transportation Association of Canada (TAC) as the sight distance available from a point where vehicles are required to stop on the intersecting road, while drivers are looking left and right along the major roadway, before entering the intersection. The sight distance is considered adequate when it allows the driver to safely enter an intersection and make the turning maneuvers permitted by the intersection layout, without significantly affecting vehicles travelling on the main roadway. See the SIGHT DISTANCE AT INDIVIDUAL ACCESSES diagram on page 10.

TRAFFIC CONTROL MANUAL 2018

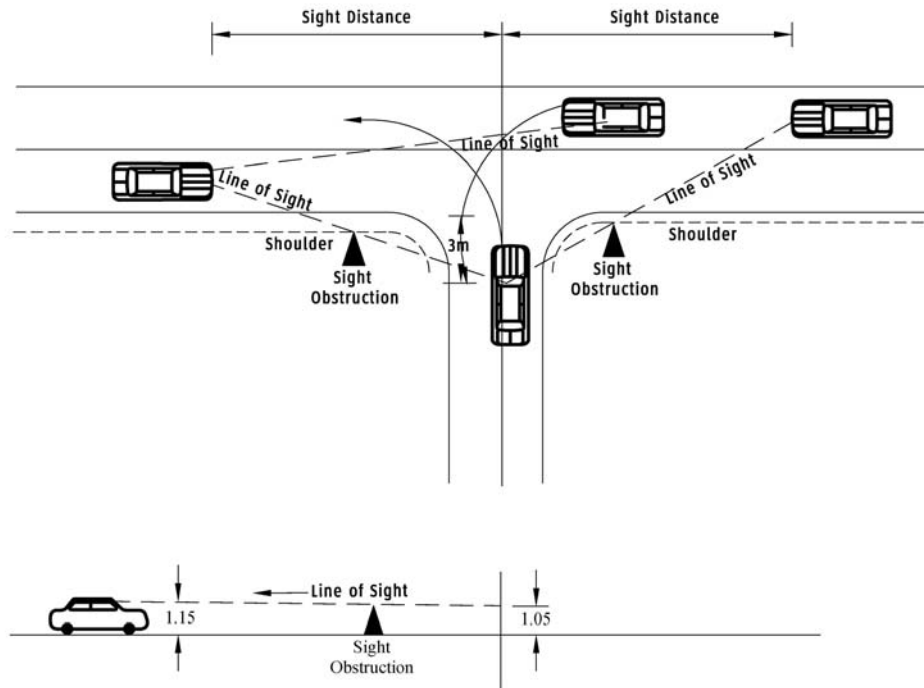

Highway Posted Speed kph	Sight Distance for Turning Movements m
100	225
90	205
80	180
70	160
60	135
50	115
<50	80

NOTES:

1. Sight distance for turning movements derived from Fig 2.3.3.4 of TAC Manual, 1999 Edition.
2. Distance from edge of travel lane to drivers eye is 3 metres.
3. Height of drivers eye is 1.05metres.
4. Height of approaching vehicle is 1.15metres from Table 1.2.5.1, TAC Manual, 1999 Edition.
5. Intersections with roadways to be designed according to TAC Standards.

5.0 TEMPORARY CONDITIONS SIGNS

5.1 SIGN SPECIFICATIONS

Unless modified by the following, the specifications outlined in the Manual of Uniform Traffic Control Devices for Canada will apply to temporary condition signs in all details concerning symbols, lettering, illumination, reflectorization, position, installation, material, support, and maintenance.

One sign only shall be placed on each support, with the exception of tab signs installed to provide supplementary or complementary information associated with warning signs or detour signs, or with the exception of signs placed on the back (reverse) side of the same support, which is intended for motorists traveling in the opposite direction.

Temporary Condition Signs – shall have black symbols or lettering on an orange retro-reflectorized High Intensity Prismatic background. **The use of florescent paint on signage shall not be considered and is not acceptable.**

Regulatory and Information Signs – which may be used for temporary traffic control or guidance shall have the same color and shape as described in the Manual of Uniform Traffic Control Devices for Canada.

Signs shall be in reasonable condition to be effective for both day and night conditions. While signs cannot always be in new condition, signs shall always be in reasonable condition. Unacceptable conditions that warrant replacing include: signs covered in asphalt splatter, dirt, dust or snow; have several large abrasions or tears; have deformation and dented considerably; have significant loss of lettering; lettering has been touched up or poorly modified; message is partly missing or illegible; have colour fading or loss of more than 20 % of its reflectivity.

Motorists require clear and simple information at the appropriate time to ensure safety of all road users:

- If given too early, it may be forgotten.
- If delivered too late, motorists may not be able to react appropriately to the approaching roadway conditions
- Too much information may be ignored, or will divide the driver's attention between the messages and the driving tasks.

To ensure that the appropriate message is delivered all signs will be placed along the roadway at the locations as identified on the traffic control layouts. If the exact position for a sign provides poor visibility or interference with other objects (access points, crosswalks, etc.), then the sign location will be extended by the minimum distance needed to alleviate the issue, such as visibility concerns or obstructions, up to a maximum of 10 meters.

5.2 PORTABLE OR REMOVABLE SIGN SUPPORTS WITH FLAGS

In construction zones, where the use of permanently installed rigid sign supports are not considered or required, temporary condition signs shall be installed on portable or removable sign supports. Signs shall be located on the right side of the roadway not to exceed 4.0 m from the edge of the traveled portion of the roadway. Supplementary signs shall be located on the left hand side of the roadway on divided highways.

If portable sign supports do not elevate temporary condition signs to the minimum required height, then two orange flags must be installed on the portable sign support, such that the required height is achieved. See drawing 790-1.

5.3 PERMANENTLY INSTALLED TEMPORARY CONDITION SIGN SUPPORTS

In construction zones, where the use of portable sign supports are not desired or properly maintained, temporary condition signs shall be installed on permanently installed rigid sign posts, as directed by the owner. Signs shall be located on the right side of the roadway not to exceed 4.0m from the edge of the traveled portion of the roadway. Supplementary signage shall be located on the left hand side of the roadway on divided highways.

Signs 900mm or less in width/length shall be installed on a single post to a height of 1.5m to 2.5m above the traveled portion of the roadway to the bottom edge of the sign. Most signs in this category can be securely installed on 100mm x 100mm wooden posts with a minimum of 1.0m of the post in the ground. Care must be exercised to ensure that the post is securely anchored in the ground so that it cannot be 'turned' or removed by vandals.

Signs exceeding 900mm in width/length shall be installed according to guidelines in the Department of Transportation and Works Specification Book, Section 580, Sign and Signpost Installations, for the corresponding size of the sign.

The use of flags to achieve minimum required heights on permanently installed sign posts shall not be permitted.

5.4 MOUNTING CHEVRON AND HAZARD MARKERS ON REBAR FOR INSTALLATION ON PAVED SURFACES

Where traffic has to be diverted or channelized to cross multi-lanes of paved surfaces, delineator devices, such as hazard markers and chevrons, shall be installed as outlined in this section.

Signs 300 mm or less in width shall be installed on a single piece of 25 mm rebar to a height

of 1 m minimum above the traveled portion of the roadway to the bottom edge of the sign.

Signs greater than 300 mm in width shall be installed on two pieces of 25 mm rebar to a height of 1 m minimum above the traveled portion of the roadway to the bottom edge of the sign.

5.5 CHEVRON AND HAZARD MARKERS USED DURING THE WINTER SEASON

Chevrons and Hazard markers shall be mounted on rebar or wooden posts in order to delineate traffic through a transition. Signs shall be installed as outlined in the Department of Transportation & Works Specifications Book, Sections 701.08 and 701.09.

5.6 INTERSECTING ROADS

Consideration shall be given to signing intersecting secondary roadways that exist within a work zone and the area reserved for the approach signage to the work zone. As a minimum, this signing shall consist of a TC-1 Construction Ahead sign displaying an appropriate directional arrow. See drawings 756-1 and 756-2 for examples of signing intersecting roads. Additional signage on the intersecting roadway may only be considered if the last two signs in the sequence of approach signage are not apparent to motorists on the intersecting roadway. Adjusting sign spacing may also be considered as a means of reducing sign requirements on intersecting roadways while providing pertinent information that is apparent to all motorists. In all situations, the placing of signs shall be based on a review of traffic conditions, traffic volumes, sight distances and sound technical judgment.

5.7 INACTIVE WORK ZONES

At all times the appropriate traffic control must be in place and provided at work areas, even if the work zone is inactive. This is particularly important for nighttime closures, weekends, and holidays. The following are key elements regarding inactive work areas:

- Where possible, construction equipment and materials shall be stored clear of the travelled roadway. When this is not possible, clearly mark these obstructions and clearly delineate the path around them.
- Ensure that all traffic control devices are protected as best as possible from weather and vandalism.
- Remove, cover, or turn off any permanent signs or devices that conflict with the temporary devices.
- Remove, cover, or turn off any temporary signs or devices that are not applicable

when the site is inactive.

- Excavations must be backfilled, delineated by barriers, or covered in an approved manner while the work zone is left unattended
- Inactive sites should be routinely inspected to ensure signs and devices remain in place are able to provided adequate roadway guidance.

6.0 TEMPORARY CONDITION DEVICES & DELINEATION

6.1 APPLICATION

Temporary condition and delineation devices shall be used to channelize traffic when traffic flow is impeded as a result of obstructions, work areas or a narrowing of the roadway. They form part of the general category called **Traffic Control Devices** and shall be used as a supplement to signs and barricades.

Where the temporary condition exists during darkness, delineation shall be achieved by the use of construction markers, traffic barrels, barricades, chevron markers, delineator posts, flashing beacons or similar devices. In all cases, markers and barricades used to achieve delineation during the hours of darkness shall be retro-reflectorized using high intensity grade sheeting to show the same color and shape by night as by day. **Fluorescent paint shall not be used as a reflectorized substitute and is not acceptable.**

Delineators including all construction markers, chevrons, barricades etc. shall be in reasonable condition to be effective for both day and night conditions. While delineation devices cannot always be in new condition, they shall always be in reasonable condition. Unacceptable conditions that warrant replacing shall be those which are: covered in asphalt splatter, dirt, dust or snow; have several large abrasions or tears; have deformation and dented considerably; have significant loss of lettering; lettering has been touched up or poorly modified; message is partly missing or illegible; have colour fading or loss of more than 20 % of its reflectivity.

6.2 LOCATION OF DELINEATION DEVICES

Any construction or maintenance activity on or within 1 m of a roadway shall be marked by delineators along the work site and the approaches to the work site or obstruction. The angle at which the delineations are placed across the closed portion of the road is called the taper and should vary according to the maximum regulatory speed and shall be as follows:

Regulatory Speed Limit	Minimum Taper
50 km/h and less	30 m
60 km/h	40 m
70 km/h	60 m
80 km/h	90 m
90 km/h	110 m
100 km/h	180 m

If the work area affects more than one traffic lane width, each traffic lane shall be closed separately and a tangent section provided between the two tapers. The minimum length of the tangent section shall be as follows:

Regulatory Speed Limit	Minimum Tangent Between Tapers
50 km/h and less	50 m
60 to 70 km/h	100 m
80 km/h	150 m
90 km/h or greater	240 m

6.3 SPACING OF DELINEATORS

The centre to centre distance between delineators varies with the regulatory speed for both tapers and tangents. Refer to the Construction Distance Table 799-1 on each layout.

6.4 CONSTRUCTION MARKERS (TC-62 and TC-62A)

Construction Markers shall be of the dimensions indicated. They shall be retro-reflectorized using high intensity grade orange reflective sheeting to indicate the same color and shape by night as by day.

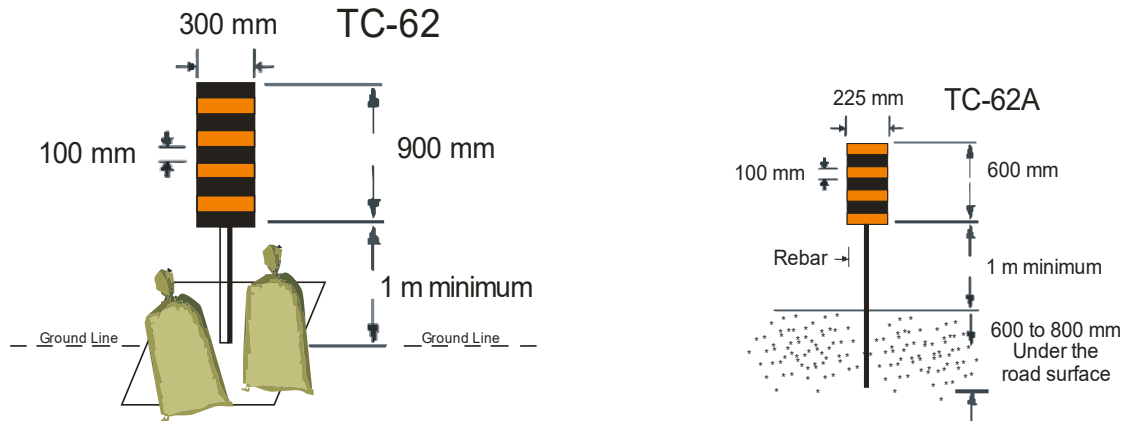

Where Construction Markers are required for a distance of greater than 300 m the use of 225 mm x 600 mm marker is permissible. (TC-62A).

6.5 CHEVRON MARKERS (TC-31)

Chevron Markers shall be used on tapers for detours and diversions. They shall replace the normal construction marker at a spacing of every 30 m from the start of the taper. The arrow head shall point in the direction of the turn. They shall be retro-reflectorized using high intensity grade orange reflective sheeting to indicate the same color and shape by night as by day.

Markers that may require a weight to keep them from being knocked down or blown over, shall use sandbags. **The use of rocks or boulders will not be considered.**

TC-31 signs shall be installed on two piece of 25 mm rebar to a height of 1 m minimum above the traveled portion of the roadway to the bottom edge of the sign.

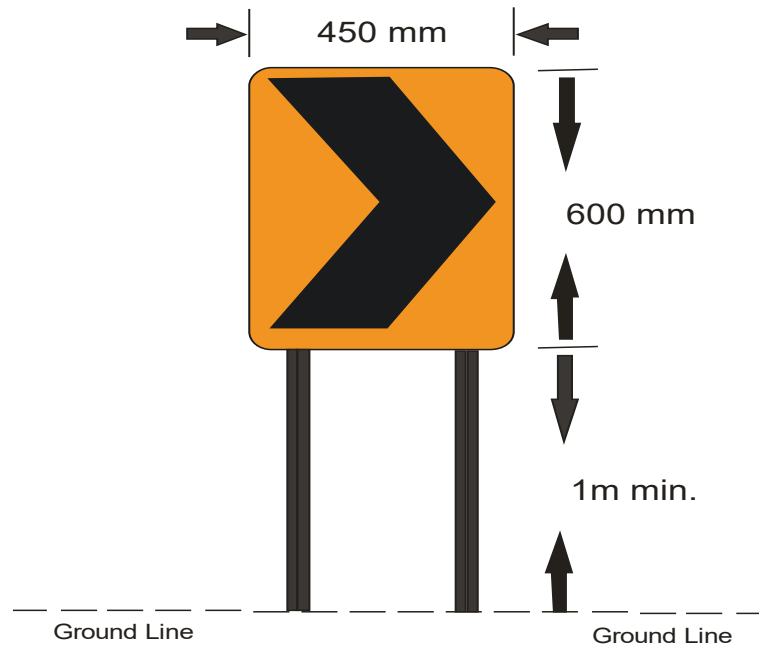

Where chevron markers are used to divide two-way traffic, chevron markers must be installed back-to-back on both sides of the same rebar installation.

6.6 BARRICADES

For reasons of traffic safety and for the protection of workers, barricades shall be used to define the work area where required by the traffic control layout and is considered a part of the temporary signing arrangement. Barricades shall also be used to close streets or roads in the area where the work is being carried out.

Barricades are always placed immediately preceding the work area on the approach side between the road user and the obstruction or activity.

These barricades shall be reflectorized to indicate the same color and shape by night as by day. **The use of fluorescent paint on barricades shall not be considered for use after dark.**

All barricades shall have a retro-reflective high intensity grade orange background and black print meeting the approval of the Department.

6.7 LIGHT BARRICADE

Light barricades shall be used for work of short duration to provide closure of a traffic lane or roadways or blocking road excavation sites or other work site hazards. Light barricades shall not be used as a channelizing device. The use of fluorescent paint on light barricades shall not be considered for use after dark (TC-64A sign is required on each light barricade).



Flashing Beacon (Optional)

6.8 HEAVY BARRICADE

Heavy barricades shall be used to provide complete closure of a road or lane for an extended period of longer than five days. Their supports shall consist of posts set in the ground with two TC-64C heavy barricade faces attached as shown below:

**The direction of traffic indicated by arrow.
Posts shall be 100 mm x 100 mm minimum.**

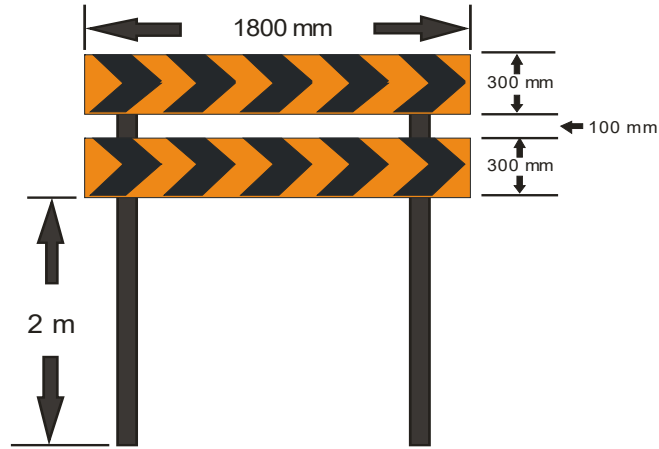

Where no direction is required barricade TC-64B shall be used, as shown below:

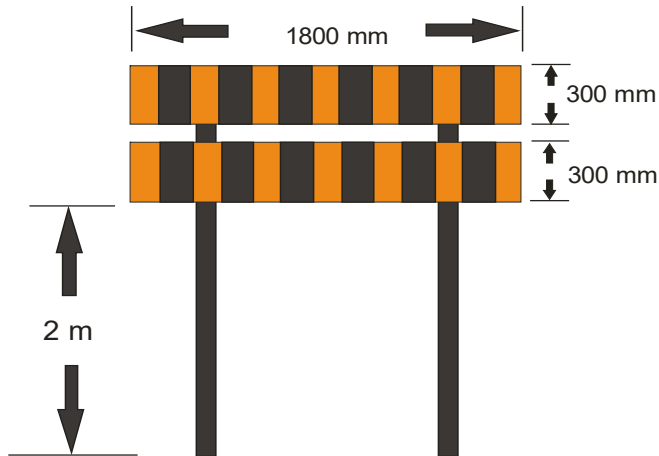

Posts shall be 100 mm x 100 mm minimum.

6.9 TRAFFIC CONES

The required height of traffic cones is related to the normal maximum posted speed of the roadway and shall comply with the following minimum requirements.

Maximum Speed (km/h)	Minimum Height (mm)
50 km/h or less	450
Greater than 50 km/h	700



The use of traffic cones is only permitted during hours of daylight.

6.10 DELINEATOR POSTS

Delineator posts used to channelize or delineate traffic shall be 1100 mm in height and 100 mm in diameter. The markings consist of two white high intensity reflective bands 75 mm in width. Unit is weighed down with a standard 6.8kg (15lb) rubber base. Extra 6.8kg (15lb) base inserts may be required to prevent turning by wind conditions.



6.11 DRUMS

Drums are to be flexible and typically 200 liters in capacity. Drums shall be reflectorized to indicate the same color and shape by night as by day. The drums are to be predominantly orange, not fluorescent, with a minimum of two white reflectorized strips (100 mm width minimum) per drum.

Flexible drums may be used as an alternative method to channelize or delineate flow and shall be approximately 1000 mm in height and a minimum of 550 mm in diameter at the base. The markings on the flexible drums shall be horizontal, circumferential alternating black and reflectorized orange strips. Drums frequently require weighted bases to prevent movement.



6.12 BARRIERS

Barriers are devices designed to physically prevent road users from entering into the work zone area which may be occupied by workers, materials, equipment or hazards. Barriers provide the following primary functions:

- Protect workers by preventing errant vehicles from entering the work zone.
- Protect errant drivers by redirecting them from a hazard.
- Provide separation for two-way traffic on one side of a normally divided roadway.

Barriers will typically be found installed in areas around excavations and scaffolding where the prevention of vehicles entering this area is of high importance.

In order to be effective, barriers must be properly installed otherwise they may pose a hazard instead of providing protection. Proper installation practices include:

- Securely fastening individual barrier devices together to form a continuous structure that acts as a single unit when impacted.
- Ensuring there are no gaps between each barrier device.
- Ensuring that the barrier is installed at a 4:1 taper on the approaches to minimize the probability of blunt end collisions.
- Any blunt ends exposed to traffic must be protected by an impact attenuator. The

attenuation devices used must meet the requirements, based on the roadway speed limit, of the National Highway Research Program NCHRP 350 TL-3 for current inventory and MASH TL-3 for devices acquired after 2018.

- Maintaining at least a 0.5 m offset between the Barrier and the adjacent travelled lane, where possible
- Installing appropriate retroreflective markings, such as construction markers or other devices meeting a minimum ASTM Type III, along the length of the barrier system.

There are many different types of Barrier devices available. The only Barrier device pre-approved for use on provincial roads is the F-shape concrete Barrier meeting the NCHRP 350 TL-3 standard. Other Barriers may be approved by the Department of Transportation and Works, provided the devices offer an equivalent level of protection.

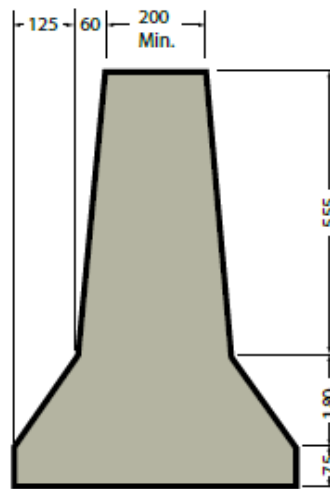

6.13 FLASHING ARROW BOARDS

Flashing Arrow Boards (FABs) are traffic Control Devices comprised of a group of lighting elements capable of displaying directional arrows (Arrow Mode) or a horizontal line (Caution Mode).

Arrow mode may be used on multilane roads to direct approaching traffic from a closed lane into the adjacent open lane. The caution mode may be used on both multilane and two lane roads when the location of work does not require any lane closures or when a Traffic Control Person is directing traffic. The left arrow shall never be used on a two lane road, as this may cause drivers to divert into the lane of oncoming traffic. No other displays, such as sequential arrows or ‘four corner’ warning lights, are permitted.

For highways with a speed limit equal or greater than 90 km/h, detours and diversions that are anticipated to be in place 12 hours or more shall have a standalone flashing arrow board unit located within each taper. The arrow board shall be of a type and design as approved by the Department of transportation and Works.

Flashing arrow boards shall have an arrow head height of 600mm to 760mm and a minimum length of 1200mm to 1500mm. These arrow boards shall consist of an array of a minimum of fourteen (14) AMBER lights, with each light being 100mm in diameter, and provide a minimum legibility distance of 600m. The AMBER arrow signals shall be on a black background with all bulbs displaying the same yellow or amber colour and light intensity. The flashing arrow boards may be mounted on a vehicle or trailer and will achieve a height from the driving surface to the centreline of the Flashing arrow board of approximately 2.2 m when it is in the upright position.

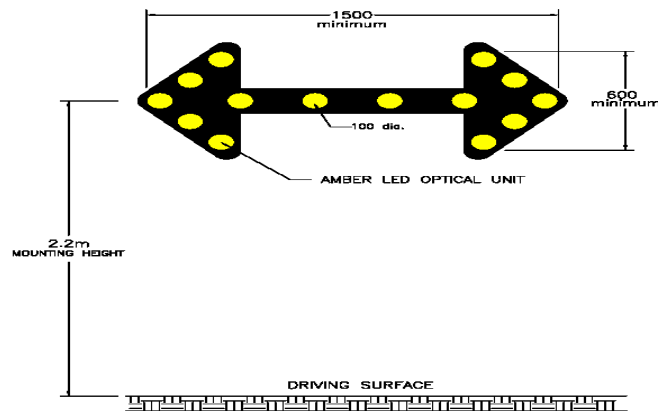

Flashing Arrow Boards shall be in reasonable condition to be effective for both day and night operation. While such devices cannot always be in new condition, they shall always be in reasonable condition. Unacceptable conditions that warrant replacing shall be those which operate: in Arrow Mode with 2 or more lamps out in the bar or any out in the arrow head; or have less than 5 bulbs operating in Caution Mode.

A 35 watt incandescent bulb is considered the standard element for flashing arrow boards. Alternate elements such as low wattage or halogen bulbs and groups of light-emitting diodes (LEDs) may be used provided they maintain the same flash rate and brightness as a 35 watt incandescent bulb. Any flashing arrow board used during night work shall be equipped with at least one photocell that progressively reduces light intensity during hours of darkness to prevent road users from being temporarily blinded.

6.14 ATTENUATION DEVICES

Attenuation devices are energy absorbing devices that may be attached to a truck or in a trailer format which upon impact deform in a controlled manner. Attenuation Devices perform the following functions:

- Reduces the rate of deceleration of the errant striking vehicle thereby reducing the impact upon the attenuation device which also reduces the likelihood of injury to the occupants of the vehicle striking the attenuator.
- Reduces the rate of acceleration of the attenuator device, thereby protecting the attenuator operator if it is truck mounted, and protecting the workers in the work zone.

Attenuation devices, either truck mounted or trailer type, must meet the requirements of the National Highway Research Program NCHRP 350 TL-3 for current inventory. Any attenuator acquired after April 2016 must meet MASH TL-3 standards. (Manual for Assessing Safety Hardware which is administered by the American Association of State Highway and Transportation Officials, AASHTO).

Sign Layout Diagrams have been developed showing use of attenuation devices, however these devices may also be included in other layout diagrams and situations for added protection of workers in work zones. In general these devices shall be placed in advance of the work zone within the buffer area.

6.15 BUFFER VEHICLE

Buffer Vehicles, typically a truck with a truck mounted attenuator, are placed in advance of the work zone and used to block a travel lane to protect workers from errant vehicles. In addition to the truck mounted attenuator a buffer vehicle shall have a flashing arrow board to provide warning and guidance to approaching vehicles.

The buffer vehicle used must meet the truck mounted attenuator manufacturer's requirement, such as overall vehicle mass, in order for the device to be effective. The truck mounted attenuator must be approved to meet the following requirements:

- If approved before 2018.01.01, it must meet the requirements of NCHRP 350 Level TL-3(100km/h impact speed).
- If approved on or after 2018.01.01 it must meet MASH TL-3 standards.

While in active use as a temporary traffic control device, a buffer vehicle:

- Must be fitted with a highback seat and a head rest for the operator.
- Must not be loaded with materials that would have a reasonable expectation of causing a fire or a chemical hazard, if the vehicle is struck.
- Must not carry passengers while actively providing protection.
- Must remain in constant radio contact with the operators of work and control

vehicles.

- Must be positioned to protect the workers.
- Must display the correct flashing arrow board message.
- Must have the wheels angled away from the open travel lane and workers.

When a buffer vehicle is used at a stationary location in advance of the work zone the additional requirements must be followed:

- Have the vehicle's brakes set.
- Be placed in 'park' or in a low gear.
- Be unoccupied while performing the blocking function.

6.16 CONTROL VEHICLE

Control vehicles used during Very Short Term Work (low speed or low volume), Short Term Work (low speed or low volume), and Snow Cleanup Operations, shall be equipped with a vehicle mounted flashing arrow board. In addition, the vehicle shall be equipped with a 360 degree beacon, standard four-way flashers and two bumper mounted signs, being 150mm high x 450mm long, with orange and black alternating and opposite stripes at 45°. The signs shall be reflectorized to indicate the same shape and color by day or night. Examples of the use of this vehicle can be found on pages 80 to 85.

Where the nature of the operations does not encroach on the travel lane or impede traffic flow, such as slow moving inspection of culverts or utility lines, etc., the control vehicle may be substituted by an alternate vehicle equipped with flashing lights and a roof mounted 360 degree revolving, appropriately coloured, beacon. If this type of operation becomes stationary for periods exceeding 30 minutes and the parked distance from the travel lane does not exceed 0.6m, then the operation is no longer considered very short term work, and shall be signed as per the relevant Work Adjacent to Roadway diagrams in section 750.

6.17 PILOT VEHICLES

Pilot vehicles may be used in situations where traffic control is required over a considerable length of work zone and where it may otherwise be difficult to control traffic with traffic control persons or temporary traffic signals. The decision to use Pilot Vehicles to control traffic rests with the road authority having jurisdiction. The pilot vehicle may guide or lead a platoon of vehicles in one direction through the work zone where it would be complex to delineate and would be more efficient to pilot traffic. Pilot vehicles may also be used to control vehicle speeds in the work zone and to protect workers by preventing vehicles from entering a closed lane too soon (such as when milling asphalt or waiting for placed asphalt to cool.).

The following procedures shall be used when Pilot Vehicles are used:

1. Traffic Control Persons (TCP) shall regulate traffic at each end of the Pilot Vehicle controlled section. The operation of using Pilot Vehicles must include communication links with the other traffic controls at each end of the work zone, such as the TCPs.
2. The Pilot Vehicle shall move into leading position at the front of the stopped vehicle queue prior to release by the TCP.
3. When directed by the TCP, the Pilot Vehicle shall guide traffic through the Work Zone, travelling at a speed that would keep traffic together in a continuous flow till the end of the work zone.
4. At the end of the Work Zone, the Pilot Vehicle shall pull over at the first safe location to allow the queue of vehicles to pass.
5. When the last following vehicle has passed, the Pilot Vehicle shall then return to the end of the Work Zone to guide a queue of vehicle back to the original starting end of the work zone.

To maintain driver discipline and ensure delays are kept to a minimum, at least two Pilot Vehicles shall be used in this continuous operation. More Pilot Vehicles would be required for a higher volume roadway with a long work zone. All Pilot Vehicles should be equipped with a 360 degree amber flashing light and a “Follow Me” sign mounted over a “Do Not Pass When Flashing” sign mounted in a conspicuous location on the rear of the Pilot Vehicle. Where significant queuing occurs or is expected to occur, or visibility at the end of the queue is not sufficient a “Prepare to Stop” Sign should be used upstream of the expected end of the queue.

Work vehicles that enter the work zone should be managed by the Traffic Control Persons so that they are the last vehicle in the Pilot vehicle queue, to avoid other vehicles following the work vehicles in the Work Zone.

Where work zones extend over a long distance and pilot vehicles are in use for traffic control, intermediate signs should be placed at 0.5 km intervals to restrict vehicles from passing. Sign RB-31 “Do Not Pass” with tab sign RB-31T are required to be installed.

6.18 VEHICLE STROBE LIGHTS

Government maintenance vehicles are to be equipped with Blue Strobe Lights and a 360 degree beacon. All other vehicles, such as contractor vehicles, tow trucks, survey vehicles, etc. are to be equipped with Amber Strobe Lights and a 360 degree beacon.

6.19 PORTABLE TRAFFIC LIGHTS

With the approval of the Department of Transportation and Works, portable traffic control signals may be used to alternate traffic past a work zone, in lieu of flagpersons. The Assistant Deputy Minister shall be advised in each case of the intent to use this device before application.

Portable signals shall be used only under conditions where the lights are clearly visible to an approaching motorist such that the vehicle can be brought to a safe stop. Intensity of the signal lamps shall be maintained in such a manner that the lights are clearly visible for a distance of at least 500 meters.

It is essential that these devices be removed immediately when conditions no longer require them.

Traffic light timings are calculated using the table shown in drawing 791-1. It is essential that traffic flow be monitored regularly to determine if timing adjustments are required. Time of Day sequences may be required to handle traffic patterns which are not symmetric.

6.20 AUTOMATIC FLAGGER ASSISTANCE DEVICES (AFADs)

An Automated Flagger Assistance Device (AFAD) is an automated flagging machine that features a circular red lens, a circular yellow lens, and a gate arm. The device is considered an extension of the flagperson's arm and is used to stop/control the flow of traffic. This device is not considered as a portable traffic signal. The flagperson operates the AFAD using a remote control rather than a paddle to control traffic movement along the work zone, this allows the flagperson to be positioned outside the travel lane while still maintaining control of traffic. Two AFADs can be operated by a single TCP at one end of the work zone or at a central location, or multiple AFADs can be operated by multiple TCPs, each positioned near an AFAD. In general the AFADs are placed either at each end of the work zone area or when one unit is used, at one end of the work activity area with a TCP at the opposite end

The AFAD shall be comprised of the following:

- The AFAD shall have two 300 mm diameter signal lenses—i.e., a lens that displays solid red above a lens that displays flashing yellow. The flashing yellow lens shall also have solid yellow capability for change intervals.
- The AFAD shall have a conflict monitor that prevents simultaneous illumination of the red and yellow lenses on the same device.
- The AFAD shall have a gate arm with the following properties:
 - A fluorescent orange or red flag shall be installed at the end of the gate arm when the AFAD is in use.
 - The gate arm shall be at least 3.05 m (10 feet) long, including the flag, and shall have a vertical aspect of at least 100 mm (4 in).

- The gate arm shall lower and remain lowered on a red signal.
- The gate arm shall rise to an upright position on a flashing yellow signal.
- The gate arm shall have retroreflectivity on both sides with alternating fluorescent red and white bands. The bands shall be 200 mm (8") long measured horizontally.
- A black-on-white STOP HERE ON RED or STOP HERE ON RED SIGNAL sign shall be installed on the right side of the approach at the point where drivers are expected to stop. This sign is typically provided with the AFAD, and may be installed on it.

The following guidelines must be considered when determining possible use of AFAD's within a work zone:

- AFADs may be used only on two-lane, two-way roadways and on multilane roadways that have been reduced to one lane.
- AFAD are suitable for low speed locations. High-speed roadways require a speed reduction.
- An AFAD is not a traffic control signal, and it cannot be used to replace or substitute for a continuously-operating temporary traffic control signal.
- An AFAD can be operated only by a TCP who has been trained to operate it.
- A TCP operating an AFAD shall not leave it unattended at any time while it is in use.
- The preferred operating procedure is to have a TCP controller for each AFAD. Assigning a TCP to each device becomes more critical on high-volume roadways and in more complex work zones where construction traffic may be entering and exiting frequently. For simpler, lower volume situations where there are good sight lines, a single TCP may control up to two AFADs:

Where AFAD's have been implemented on a work zone, the following conditions must be observed:

- For road users to **stop**, the AFAD shall display a **steadily-illuminated red lens** with the gate arm in the down position.
- For road users to **proceed**, the AFAD shall display a **flashing yellow** lens with the gate arm in the upright position.
- For the **change** interval between flashing yellow and steady red, the AFAD shall display a **steadily-illuminated yellow lens** with the gate arm remaining in the upright position. The change interval should be at least 3 seconds unless a different duration is approved by engineering judgment. There is no change interval between the steady red and flashing yellow displays.
- During operations with two flagpersons:
 - One flagperson shall operate each AFAD at either end of the work zone; or
 - One flagperson shall operate an AFAD at one end of the work activity area and the second flagperson controls traffic with a paddle at the other end.
- During operations with one flagperson:
 - The flagperson is positioned in a central location simultaneously operates two AFADs that are positioned at either end of the work zone; or

- The flagperson operates a single AFAD that is positioned at one end of the work activity area while also controlling traffic with a paddle at the opposite end.
- During single operations with one flagperson, all of these conditions shall be met:
 - The flagperson has an unobstructed view of the AFAD(s).
 - The flagperson has unobstructed views of approaching traffic in both directions.
 - The average daily traffic volume on the roadway is 6,000 vehicles or less.
 - The maximum distance between traffic control locations (TCP or AFAD) is 250 m.
- A TCP shall not activate the flashing yellow display (proceed) until the last vehicle from the opposing queue has cleared the work activity area.

Refer to Layouts 792-1 through 792-4 for application of AFAD's.

6.21 VARIABLE MESSAGE SIGNS

Variable Message Signs are electronic signs that are used to convey additional information about upcoming road work. These signs shall be used only as a supplement to, but not a substitute for, conventional temporary condition signs and devices. Their use in the field shall be limited to installation either prior to, or within the advance warning area. The Highway Maintenance Division of the Department of Transportation and Works shall be contacted prior to the use of Variable Message Signs on provincially controlled highways or projects.

Variable Message Signs may display either a single fixed message or a number of sequential messages. When programmed to display sequential messages, each message will be referred to as a phase. Each phase shall be visible to approaching motorists for a minimum of three seconds, and shall be able to be read at least twice by the approaching motorist. If sequential messages exceed two phases, additional Variable Message Signs may be required. In this situation, the distance between Variable Message Signs shall be given careful consideration, based on the speed limit and the phase cycle, ensuring that the message(s) on each sign can be read twice by approaching motorists.

The following guidelines shall be used to determine the information to be displayed on Variable Message Signs:

- Messages shall consist of upper case text with a minimum letter height of 30cm.
- The messages shall be displayed in bright yellow or orange, providing a sharp contrast to the sign's black or dark blue/grey background colour.
- Each message shall convey a single, relevant and concise thought.
- Abbreviations shall only be used if they are easily understood.

Roadway construction or maintenance applications, where Variable Message Signs may be considered, include the following:

- On high speed, multi-lane roadways where significant delays, queuing or lane changes are anticipated;
- On high volume roadways where complex and frequently changing alignment or surface conditions exist;
- Approaching a construction or maintenance project where an alternate route may be available, but not apparent to approaching motorists.

Variable Message Signs shall be in reasonable condition to be effective for both day and night operation. While such devices cannot always be in new condition, they shall always be in reasonable condition. Unacceptable conditions that warrant replacing shall be those which operate with less than 90% of the pixels in each character.

6.22 RADAR DISPLAY SPEED SIGNS

Radar Display Speed Signs are electronic signs that are equipped with a radar unit that detects an approaching vehicle's speed, and displays the information back to the driver. These signs shall be used only as a supplement to, but not a substitute for, conventional temporary condition signs and devices. Their use in the field shall be limited to installation within the approach area, where speed control is essential. The Highway Maintenance Division of the Department of Transportation and Works shall be contacted prior to the use of Radar Display Speed Signs on provincially controlled highways or projects.

Radar Display Speed Signs shall only be used where speeding is an issue, and to achieve maximum effectiveness, their use should be supplemented with law enforcement from time to time. Where approved for use a Radar Display Sign shall meet the following requirements:

- The numbers displayed on Radar Display Speed Signs shall be a minimum of 45cm high.
- The threshold speed to activate the sign's display shall be set at a minimum of 5km/h over the posted speed.
- A maximum threshold speed to activate the sign's display shall be set to prevent drivers from try to test how fast they can go.
- If the sign is capable to display any supplementary message, then the minimum requirements for Variable Message Signs shall apply.
- The only approved message for display shall be "SLOW DOWN".
- Signs shall be installed in the Approach Area adjacent to posted speed limit signs, where present as part of the typical advance warning signage, or in a similar location when reduced speed limit signage is not required.

6.23 TEMPORARY CONDITIONS PAVEMENT MARKINGS

Temporary Conditions Pavement Markings are used in combination with other appropriate warning signs, delineation devices and traffic control devices to mark the intended vehicle path traffic is expected to follow through the work zone.

Instances where temporary pavement marking may be used are on a paved diversion to bypass a work site, such as a new bridge construction, or where partial pavement removal or incomplete replacement has occurred in a multiple asphalt overlay process.

Where temporary condition pavement markings are used they shall be placed as soon after an original lane marking has been removed to restore the guidance which was in place prior to the construction operations. In the case of temporary diversions, lane markings shall be placed prior to opening of the diversion.

Whenever temporary condition pavement markings are applied, any conflicting pavement markings shall be removed or obscured to eliminate any possible confusion. Paint grinders and black sealing compounds can be used but must be approved for the removal operation based on existing lane marking conditions.

Typical temporary pavement markings consist of temporary marking tape, raised pavement markers and standard traffic paint with glass beads. Yellow markings shall be used where two-way traffic occurs and to delineate opposing traffic. White markings shall be used for shoulder edge lines or multiple lanes where traffic flows in the same direction, such as on divided highways.

Short term lane markings may be smaller in size and with a less frequency of spacing. More temporary markings shall be used in areas of curves than on straight sections to highlight road curvature. Temporary markings for long term applications shall follow usual line painting practices governed by national standards.

6.24 TEMPORARY RUMBLE STRIPS

Temporary rumble strips are portable rubber devices placed across a roadway perpendicular to the direction of traffic flow. The primary use of temporary rumble strips is their effectiveness in alerting drivers, through noise and vibration, to other traffic control devices and upcoming circumstances such as lane changes, detours, or other hazardous conditions. These devices may also provide a secondary benefit in providing a small reduction in roadway speeds in the direct vicinity of the rumble strip installation.

When determining if use of temporary rumble strips is applicable, the following key factors must be considered:

- A sign warning drivers of the rumble strips should be placed in advance of the rumble

strip installation.

- Temporary rumble strips should not be placed on roadways used by bicyclists unless a minimum clear path of 4 feet is provided at each edge of the roadway or on each paved shoulder.
- Temporary rumble strips should not be placed within intersections, through pedestrian crossings, or on sharp horizontal or vertical curves.
- Temporary rumble strips are not recommended for quickly moving mobile road work.
- Potential to cause erratic or avoidance manoeuvres by drivers.
- Potential rough ride or hazard for motorcyclists.
- Potential for movement of rumble strips due to inadequate installation.
- Noise complaints by nearby residents.
- Can result in increased braking and reduced speeds
- Temporary rumble strips are primarily practical for low speeds only because they are easily dislodged by high speed traffic.
- Even strips with very shallow depths or heights may affect control of motorcycles and bicycles, especially in night situations where these users cannot see them in advance.

Refer to Layouts 740-1 through 740-4 for general information of the placement of temporary rumble strips.

6.25 MISCELLANEOUS

Other miscellaneous traffic control devices, such as flares, flashlights, floodlights, lanterns, etc., may be used, as required, to supplement the signs and other devices described in this section.

7.0 FLAGPERSON

7.1 INTRODUCTION

Under certain conditions, during construction or maintenance activities on or along a roadway, the use of a flagperson may be required to safely guide motorists through the work site area. The following sections specify the appropriate equipment, signs, and usage of flagpersons under such circumstances. The final decision as to the use of flagpersons shall be as directed by the user's representative. The use of Automatic Flagger Assistance Devices, as detailed in Section 6.20, may be used as an alternative to flagpersons allowing for the greater safety in some situations.

7.2 FLAGPERSON EQUIPMENT

The flagperson shall, at a minimum, wear a high visibility safety jacket or vest (CSA 296-09 Class 2 Level 2), safety boots (CSA Grade 1), CSA approved safety headgear, and hearing and eye protection. They shall be equipped with a flagpersons "STOP" and "SLOW" reflectorized sign. This sign shall be attached to a support pole, such that the sign and pole combination has an overall height of 2.0m to 2.3m. For night operation, the flagperson shall have a red signaling baton flashlight to supplement the reflective diamond sign.

7.3 FLAGPERSON ADVANCE SIGN

Except for very short term work situations, "Flagperson Ahead" (TC-21) signs shall be posted in advance of each flagperson. The sign shall be of a design as shown in the Manual of Uniformed Traffic Control Devices for Canada and shall be retro-reflectorized with high intensity prismatic grade sheeting to indicate the same color and shape by night as by day.

All advance flagperson signage shall be removed or covered promptly when the flagging operations are terminated from a construction work zone for any period of time. Signage left up will be expropriated by the Department of Transportation and Works.

7.4 GENERAL GUIDELINES

Flagpersons shall be highly visible. For this reason, they must stand alone, never permitting a group of workers to congregate around them.

Flagpersons working as a team shall agree to appropriate signals before commencing their duties. If the flagpersons are not visible to one another, an intermediate flagperson or two-way radios are necessary to ensure proper communications and directing of traffic. (See TCM Layout 757-1 and 757-2)

No flagperson shall start working unless all required advance flagperson signs are in place. No other construction signs shall be located between the flagperson position and the advance flagperson signage.

The flagperson is not permitted to use a radio, cell phone or any other device which could impair sight, hearing, or attention while working. While on duty the flagperson should refrain from participating in distracting activities.

At no time are flagpersons permitted to use flags to control traffic.

No flagperson shall leave their post unless authorized to do so or replaced by another flag person. As long as traffic cannot flow freely, even at mealtime, the flagperson must stay on duty until relieved.

Flagpersons are to be located outside the active lane of traffic, typically on the shoulder adjacent to the lane of traffic being controlled, and at a point from the end of the working area so as to be able to protect personnel and equipment. The distance from the flagperson to the work site shall be based on normal speed limit and as indicated in the Construction Distance Table 799-1.

During some situations it may be necessary for a Flagperson to stand on the driver's side of the lane of traffic being controlled. This position is only allowed after more than one vehicle has been stopped from the shoulder of the lane of traffic being controlled and it is necessary for the Flagperson to move into the lane to assess queue length or to achieve a better view of approaching vehicles. The Flagperson must then return to the shoulder of the lane before directing the traffic to proceed. At no point are Flagpersons be positioned on the driver's side of the lane if the Flagperson will be exposed to traffic in the adjoining lane, as the presence of traffic will result in that position not being safe

Flagpersons and equipment operators working at a location are to make every effort to keep delays to motorists to a minimum. In heavy traffic, delays shall be split equally between the opposing lanes of traffic and in normal operations traffic shall not be delayed in excess of five (5) minutes per direction. At all times priority shall be given to the motorist to proceed through the construction zone. Flagpersons not following these guidelines shall be dismissed from the work site.

When the flagperson leaves their position at the end of operation on a work zone, the Contractor must remove or cover all applicable advance flagperson signage. The Department reserves the right to expropriate all flagperson signs that are left in place after the flagperson no longer controls traffic.

7.5 FLAGPERSON REQUIREMENTS

Any maintenance or construction activity which results in encroachment into a travel lane requires traffic control, usually in the form of flagpersons. The following construction situations shall be used as guidelines in use of flagpersons:

- At least one flagperson shall be provided on local roads when the traffic flow in one direction is diverted wholly or partially into the lane of oncoming traffic and the lane of oncoming traffic is clearly visible beyond the one lane section for the distance as shown in Table 715.05.01 for the appropriate speed limit.
- At least two flagpersons shall be provided on local roads when the traffic flow in one direction is diverted wholly or partially into the lane of oncoming traffic and the lane of oncoming traffic is not clearly visible beyond the one lane section as noted in Table 715.05.01.

TABLE 715.05.01

Max Speed	Clear Visibility Required in Each Direction
80 km/h	250 m
70 km/h	200 m
60 km/h	170 m
50 km/h	140 m
40 km/h	110 m

- The user may, where the normal traffic volume on a local road is less than fifteen vehicles per hour, reduce the flagpersons requirements.
- At least two flagpersons shall be provided on collector and arterial roads when the work activities require the traffic flow in one direction to be diverted either wholly or partially into the lane of oncoming traffic.
- At least two flagpersons shall be provided when the traffic flow in both directions is diverted from the normal vehicle path onto a one lane section. Where traffic flow in both directions is diverted from the normal vehicle path onto a two lane section, the use of a flagperson is not required. Traffic flow may be safely regulated through the area by the proper use of construction signs.
- At least two flagpersons shall be provided to direct traffic at a major detour. These flagpersons must be located at each end of the detour and must be familiar with the

area of the detour route. Extended operations of a detour will require public advertising and detour signs along the complete detour route in place of the flagpersons.

- At least two flagpersons shall be provided at truck entrances/exits on arterial roads when the truck traffic entering or exiting the access road is in excess of ten vehicles per hour.
- At least two flagpersons shall be provided at truck entrances/exits on collector and local roads with a normal traffic volume of fifty vehicles per hour on the through road and when the truck traffic entering and exiting the access road is in excess of ten vehicles per hour.
- At least three flagpersons shall be provided, as shown in Section 750 (Sign Layout Diagrams 757-1 and 757-2), on collector and arterial roads when the work activities require that traffic flow in one direction be diverted either wholly or partially into the lane of oncoming traffic and when the horizontal and/or vertical alignment at the work site does not have the distance of clear visibility required in Table 715.05.01.
- At least one flagperson shall be provided on arterial roads which have two lanes of one-way traffic and traffic volumes in excess of one hundred vehicles per hour where the work activities require that one lane be closed at the work site.
- The use of a flagperson is not required on sections of new highway which is not open to the public use.
- At least one flagperson shall be provided on a temporary bridge by-pass of one lane width. At locations where portable traffic lights are in operation, the use of a flagperson is not required. At a two lane by-pass, the use of a flagperson is not required as traffic flow may be safely regulated through the area by the proper use of construction signs.
- When traffic control is required at signalized intersections, due diligence shall be exercised and every effort made by the user's representative to deactivate the traffic lights, immediately before flagpersons are required to direct traffic through the intersection. If in the event that traffic control is required through a signalized intersection, and time restraints or emergency situations exist, such that the traffic lights cannot be deactivated immediately prior to work commencing through the intersection, then the flagpersons shall exercise caution and good judgment to ensure the traffic flow around the work zone is maintained in conjunction with the operation of the traffic light sequences. A minimum of two flagpersons shall be used at a signalized intersection. However, there may be situations, depending on the location and type of work, that require more flagpersons to be utilized.
- Any other situation as determined by the user's representative.

7.6 WHERE TO STAND

1. Stand outside the lane of traffic, typically to the shoulder of the lane being controlled.
2. Stand at a distance from the working area as indicated on the sign layout diagram, so as to be able to protect personnel, equipment and motorists.
3. Stand where you can be seen by approaching traffic.

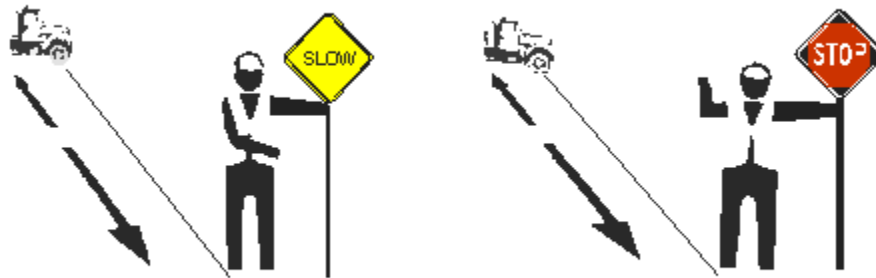

7.7 FLAGGING SIGNALS

Standard flagging signals shall be used and given in a clear and precise manner.

To instruct a fellow flagperson to halt traffic, raise the free hand with fist clenched straight above the shoulder, wave the entire arm slowly from the upright position to a position directly out to the side at shoulder height and repeat signal as long as necessary;

To indicate an all clear situation and instruct a fellow flagperson that he or she may allow traffic to proceed, raise the free hand directly out to the side at shoulder height, lower the entire arm until it rests against the side of the body and repeat signal as long as necessary;

To indicate the approach of emergency vehicles, drop the stop and slow paddle, raise both arms to the side at shoulder height, then rapidly wave both arms from the shoulder level to a point above the head where the wrists will cross and continue signal until the fellow flagperson is seen to take necessary action;

A flagperson shall stand in a safe position where he or she will be clearly visible and where he or she has an unobstructed view of approaching traffic.

Flagperson's shall use normal signals when stationed on the driver's (left) side of the lane used by traffic under his or her control and appropriate signals shall be used only when the flag person is stationed on the right side of traffic under his or her control.

- Normal signals to **STOP** traffic are:

In daylight,

The flagperson shall face approaching traffic and shall extend his or her free arm horizontally across the approach lane and

The flagpersons paddle shall be held upright with the "STOP" side facing traffic

and

When an approaching vehicle has almost stopped, the free arm shall be used to indicate the point at which vehicles are required to stop.

In darkness,

The flagperson shall assume the same basic position as for the day signal.

He or she shall hold a reflectorized paddle in his or her free hand and flashlight with red signaling baton attached in his or her free hand,

The free arm shall be moved slowly back and forth between limits corresponding to the third and sixth hour positions on a clock face, and

When an approaching vehicle has almost stopped, the flashlight and baton shall be used to indicate the point at which the vehicle is required to stop;

- Normal signals to **SLOW** traffic are:

In daylight,

The flagperson shall take up a position similar to the one used for the signal to stop with the "SLOW" side of the paddle facing approaching traffic;

In darkness,

The same position and motions shall be assumed as for the night stopping signal except that the "SLOW" side of a reflectorized paddle shall face approaching traffic;

- Normal signals to **MOVE** traffic are:

In daylight,

The flagperson shall face across the approaching traffic lane and shall look across his or her shoulder at the traffic he or she is about to move;

Traffic shall be advanced by rotating the lower free arm in an oval manner corresponding to the direction in which the vehicle wheels will rotate;

If traffic is required to proceed slowly, the flagperson shall also extend his or her free arm horizontally towards the approach lane with the "SLOW" side of the paddle facing traffic; and

If traffic is allowed to proceed at the prevailing speed limit, the flagperson shall lower the STOP/SLOW Paddle and ensure it is hidden from motorists.

In darkness,

The same signals as for daytime shall apply.

A flashlight with red baton attached shall be used in the free hand.

The order to proceed or to proceed slowly may be given verbally.

The flagpersons paddle shall not be used to wave traffic on and shall never be displayed to traffic in other than a static manner.

All motions of the flagpersons arms, both by day and night, shall be performed precisely and unhurriedly so that the meaning of signals given cannot be misunderstood.

8.0 INCIDENT SIGNING

Temporary condition signs shall be used to notify oncoming traffic that the normal flow of traffic may be impeded as a result of (1), an incident (crash) on or near the roadway ahead, and/or (2) removal of disabled vehicles on, or back on to the roadway by tow trucks. The placement of signs shall be as per the detailed Emergency Traffic Management Appendix 1, of the Traffic Control Manual. Signage may be required to be modified as first responders, police officers are in attendance with emergency vehicles and coning in place for traffic control.

Note that the use of incident signs is not intended to replace any existing safety devices or practices that law enforcement agencies now use, but rather to supplement them by giving motorists advance notice of what is occurring ahead. All towing companies are required to have these incident signs on board their tow trucks, or have them readily available for use on short notice.

Where an incident (crash) occurs along the highway which requires towing operations to remove vehicles from the highway or back onto the highway, every effort must be made to ensure that at least one lane of traffic is maintained throughout the operation at all times. This may require a police presence to direct traffic to ensure that no one direction remains stopped for periods exceeding 10 minutes, or in excess of 8 vehicles stopped in any one direction at a time. The requirements of Appendix 1 of the Traffic Control Manual shall apply to all incidents and emergencies. If towing operations require the complete closure of a highway for an extended period of time, consideration should be given to establishing a temporary detour route in accordance with the relevant Traffic Control Manual layouts supplemented with law enforcement officials as necessary.

All signs must use retro-reflective high intensity prismatic sheeting and are to be designed to comply with all specifications regarding shape, color and size, and must be kept clean and legible at all times. All signs must be printed on either aluminum, plywood, or roll-up flexible, fabric reinforced material. All signs shall be installed on portable stands.

The 'INCIDENT' type signs shall be as shown on page 42 and printed on retroreflective FLOURESCENT PINK sheeting, 3M #4084 Diamond Grade DG³ or equivalent, when applied on rigid substrates such as aluminum or plywood. Where rigid substrates are not practical, the 'INCIDENT AHEAD' sign may be printed on flexible rollup FLOURESCENT PINK material, 3M #RS24 Diamond Grade or equivalent.

TRAFFIC CONTROL MANUAL 2018

INCIDENT SIGN

90 x 90 cm Minimum



TC-301
Color-Flourescent Pink

The "INCIDENT AHEAD" sign shall be retro-reflective, 3M Diamond Grade Flourescent Pink, or equivalent, and be designed to show the same colour by night as by day. The unique colour should stand out to motorists more than regular traffic control devices. NO OTHER COLOUR WILL BE ACCEPTABLE

TRAFFIC CONTROL MANUAL 2018

INCIDENT SIGNING TOWING DURING DAYLIGHT HOURS

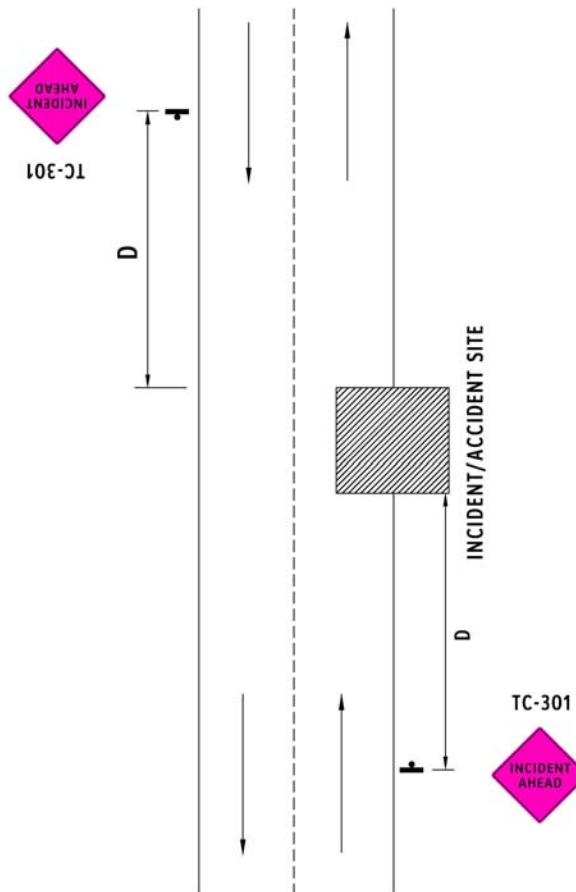

Note: For daylight hours, the distance in advance of the scene of the accident is determined by the posted speed limit in that area and is represented in the table below.

Regulatory Speed Limit	Distance (D) in Advance of Accident
50 km/h and less	100 m
60 - 80 km/h	150 m
90 km/h and more	200 m

Note: For towing during night time hours, refer to page 35 and to the "Lane Closed" diagrams in Section 752 and sign accordingly.

9.0 ZIPPER MERGE

In general, the majority of drivers upon seeing the first lane closure signs in a work area, will begin to move from their current lane into the lane that will continue through the work zone. Depending on the local conditions this method may not be the most efficient and safe way for traffic to merge. In order to increase safety and reduce speed differentials, queue lengths and traffic delays there are two methods available for use based on the local traffic conditions.

Early Merge Strategy

The early merge strategy is effective where the local conditions result in low traffic volumes combined with high average speeds. This merge strategy directs drivers to move out of the closed lane well before the lane ends and is typical for traffic control layouts.

Late Merge (Zipper Merge) Strategy

The late merge strategy is effective where the local conditions result in high traffic volumes combined with low average speeds due to congestion. This merge strategy directs drivers in the closed lane(s) to remain in their current lane(s) until they reach the designated merge point, at which time they merge with the other open lane in an alternating pattern with the traffic already in this lane.

The late merge strategy provides the following benefits:

- Reduction in travel times as traffic is kept moving in a slow and consistent fashion
- Increased traffic capacity through the work zone
- Shorter queue lengths in advance of the work zone as all lanes are used to queue traffic in approach to the work zone

A variable message sign may be placed in advance of the zipper merge to provide additional notice to motorists of the merge stagey. One of the following messages may be displayed:

- MERGE POINT / X KM / USE BOTH LANES / TO MERGE POINT
- STAY IN YOUR LANE / MERGE AHEAD
- USE BOTH LANES / SLOW TRAFFIC AHEAD

The late merge strategy should be implemented on all lane closures for multi-lane roadways, where traffic queue lengths or congestion are a concern. The layout shown on Drawing 793 shall be used as a reference when developing the zipper merge signage strategy for the project.

10.0 TRAFFIC CONTROL DEVICES: INSTALLATION AND REMOVAL PROCEDURES

Before work starts on any construction or maintenance activity, it is essential that a plan for traffic control be devised that provides protection for workers and motorists, not only during the construction activity, but also during the setup and removal of traffic control signs and devices. While each construction or maintenance activity can have its own unique circumstances that may impact the plan for traffic control setup and removal, the following basic safety guidelines shall be considered and adhered to:

- Before work starts, review the tasks to be completed and the protection that is needed.
- An emergency plan shall be in place in the event that an incident should occur, and shall take in to account the following:
 - Have a stocked first aid kit on site at all times.
 - Employees shall not work alone in the area.
 - If an incident should occur, the work supervisor shall be contacted immediately.
 - If an incident should occur, medical personnel should be contacted immediately if necessary.
- All workers shall wear personal protective equipment (PPE) that includes CSA approved high visibility clothing, safety glasses, safety boots and safety hat.
- A service vehicle shall accompany workers involved in the setup and removal of traffic signs and devices, and shall be equipped with an operating flashing light unit and standard four way flashers.
- It is prohibited for any person to ride in an area of the service vehicle not specifically designed (tailgate, box of truck, etc) to provide secure accommodation for a person, or to ride unsecured in a vehicle which is in motion.
- No activities shall commence in the work zone until all traffic control signs and devices are in place.
- A site assessment shall be completed to determine if flagpersons are required to complete the sign installation or removal process. If needed, refer to pages 27 to 33 in this Traffic Control Manual for procedures.
- While installing or removing signs or devices, workers shall:
 - Ensure the vehicle is completely stopped.
 - When installing or removing signs, exit or enter the vehicle after each sign is installed or removed, or walk along the shoulder of the road beside the service

- vehicle to complete the next task, ensuring that the service vehicle is completely stopped each time. Always complete this action with the flow of traffic.
- When installing delineation or other traffic control devices around the tapers and the work zone, exit or enter the vehicle after each device is installed, or walk along the shoulder of the road beside the service vehicle to complete the next task, ensuring that the service vehicle is completely stopped each time. Always complete this action with the flow of traffic.
 - When removing delineation or other traffic control devices around the tapers and the work zone, exit or enter the vehicle after each sign is removed, or walk along the shoulder of the road beside the service vehicle to complete the next task, ensuring that the service vehicle is completely stopped each time. Always complete this action against the flow of traffic.
 - Offload and load signs or devices from the side of the vehicle that is farthest from the open traffic lane OR if not practical, from the back of the vehicle.
 - Assemble or disassemble traffic control devices away from the roadway.
 - Avoid pointing the service vehicle towards the flow of traffic, especially at night.
- The sequence for setting up signing for a work area, requires that advance warning and approach signs be installed first, followed by the delineators, signs and traffic control devices in the tapers and tangents around the work zone.
 - The sequence for the removal of a work area requires that the traffic control devices and delineation around the tapers and tangents of the work zone be removed first, followed by the removal of the advance warning and approach signs.

Examples of sign setup and removal procedures for typical lane closure situations are shown on pages 47 to 70. These procedures shall be used as a guide for any construction or maintenance activity that requires the installation of traffic signs and devices, as shown in the Traffic Control Manual.

TRAFFIC CONTROL MANUAL 2018

SIGN SETUP (TWO LANE ROADWAYS)

SEQUENCE:

1. Begin at the first advance warning sign located on the same side of the road as the work zone.
2. Proceed with the flow of traffic, placing all signs on the same side of the road as the work zone.
3. Following placement of the last sign in this direction, make a legal turn.
4. Sign the opposite approach, beginning at the first advance warning sign and working with traffic, install all remaining signs in this approach.

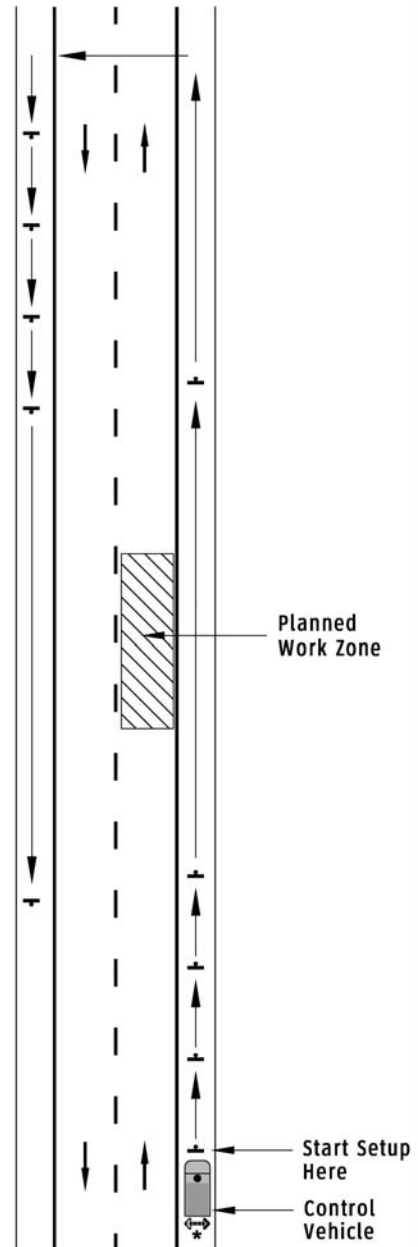

*At posted speeds greater than 80km/h a Control Vehicle is required.

TRAFFIC CONTROL MANUAL 2018

WORK ZONE SETUP (TWO LANE ROADWAYS)

SEQUENCE:

1. Ensure that flagpersons 1 and 2 are positioned as shown, if required.
2. Begin at the entrance taper, laying out all delineation devices to complete the taper.
3. Setup any signs, flashing arrow boards, barricades, or any other traffic control device required within the entrance taper.
4. Continue with traffic flow to complete the delineation and setup of any other signs, flashing arrow boards, barricades or traffic control devices required in the work zone and the termination taper.

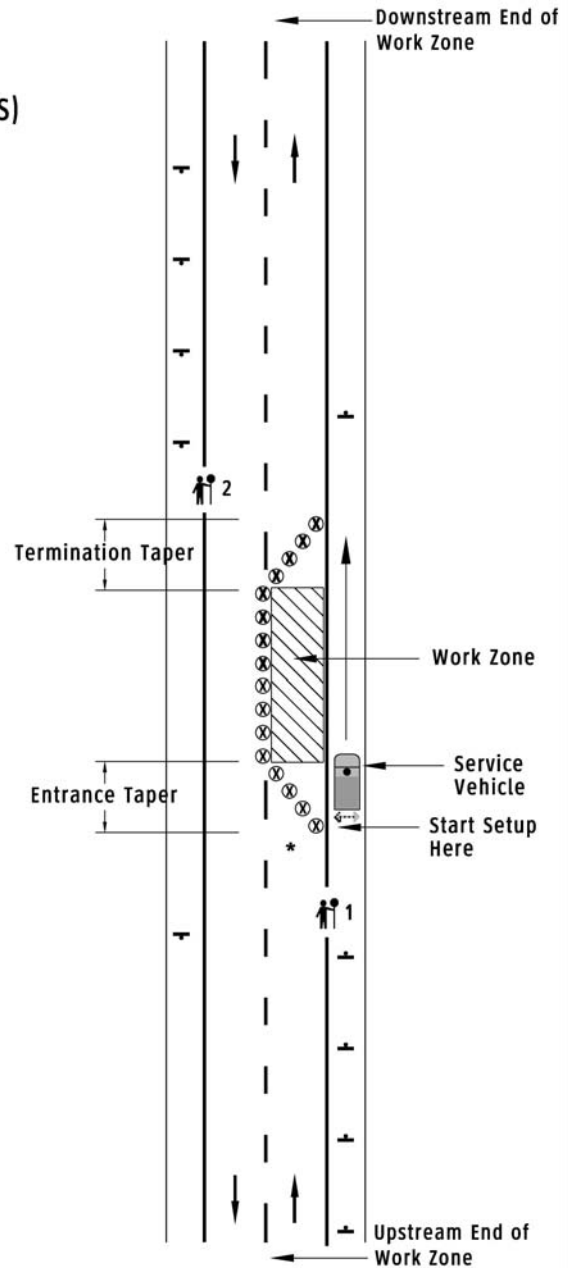

*At posted speeds greater than 80km/h a Control Vehicle is required to be positioned upstream of the Work Zone.

TRAFFIC CONTROL MANUAL 2018

WORK ZONE REMOVAL (TWO LANE ROADWAYS)

SEQUENCE:

1. Ensure that all work activities have been completed and that all workers, materials, equipment, signs and traffic control devices have been removed from the work zone.
2. Have flagpersons 1 and 2 control traffic flow in both directions, as required.
3. Begin removing the delineation devices around the work zone, beginning at the termination taper, proceeding against the flow of traffic.
4. The flagpersons shall allow traffic to proceed following step 3 above.

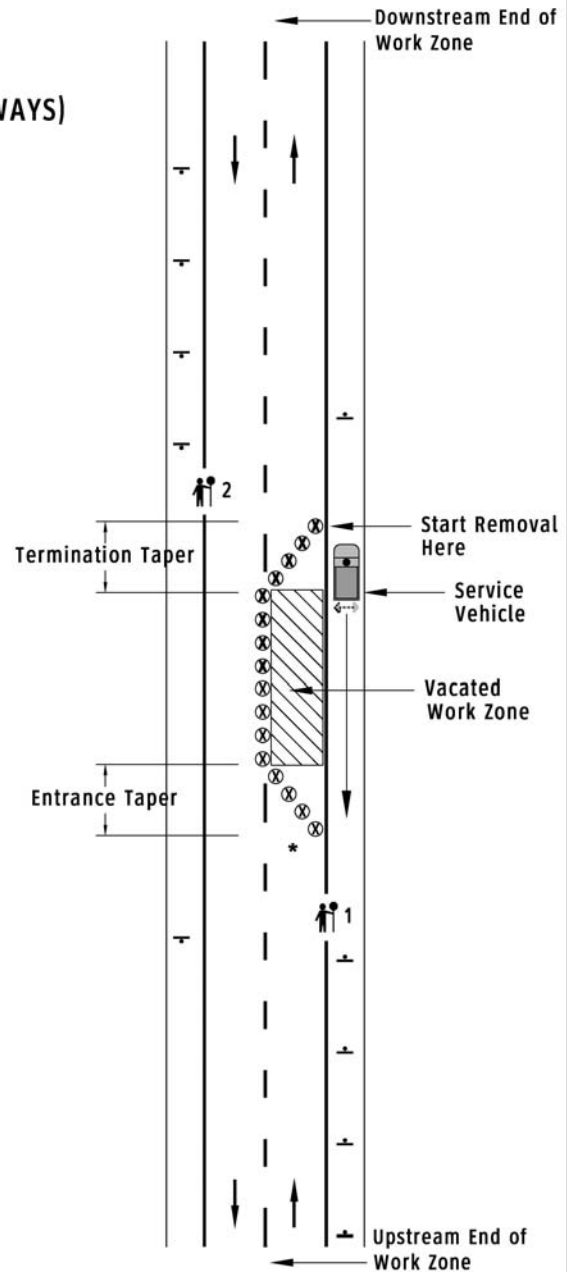

*At posted speeds greater than 80km/h a Control Vehicle is required upstream of the Work Zone.

TRAFFIC CONTROL MANUAL 2018

SIGN REMOVAL (TWO LANE ROADWAYS)

SEQUENCE:

1. Ensure that all work activities have been completed and that all workers, materials, equipment, signs and delineation devices have been removed from the work zone and the lane is open to traffic flow.
2. Begin on the same side of the road as the work zone, at a point near the start of the former entrance taper, and working with the flow of traffic, remove all remaining signs in this direction.
3. Make a legal turn.
4. Beginning at the first advance warning sign in the opposite approach, and working with the flow of traffic, remove all remaining signs in this direction.
5. Make a legal turn.
6. Beginning at the first advance warning sign located in the lane that contained the work zone, and working with traffic flow, remove all remaining signs in this direction.

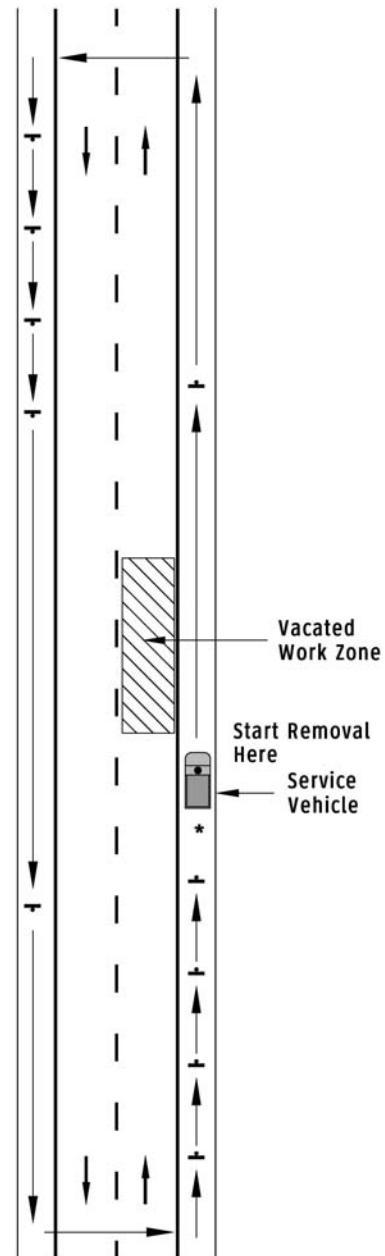

*At posted speeds greater than 80km/h a second vehicle is required.

TRAFFIC CONTROL MANUAL 2018

SIGN SETUP (FOUR LANE DIVIDED HIGHWAY)

SEQUENCE:

1. Station a control vehicle with a flashing arrow signal indicating the appropriate direction, behind the service vehicle, at a distance 'D' as shown in the Construction Distance Table, 799-1 in this manual. The control vehicle shall follow the service vehicle throughout this process at this distance.
2. Begin at the first advance warning sign located on right-hand shoulder of the divided highway and proceeding with the flow of traffic, continue placing all remaining signs along this shoulder.
3. Following placement of the last sign in this direction along the right-hand shoulder, make two legal turns (at next interchanges or median crossovers) and return to the beginning of the first advance warning sign in the left-hand (ie. median) shoulder of the divided highway.
4. Begin at the first advance warning sign located on left-hand (ie. median) shoulder of the divided highway and proceeding with the flow of traffic, continue placing all remaining signs along this shoulder.
5. This procedure shall be used for signing any lane closure or work activity along a divided highway.

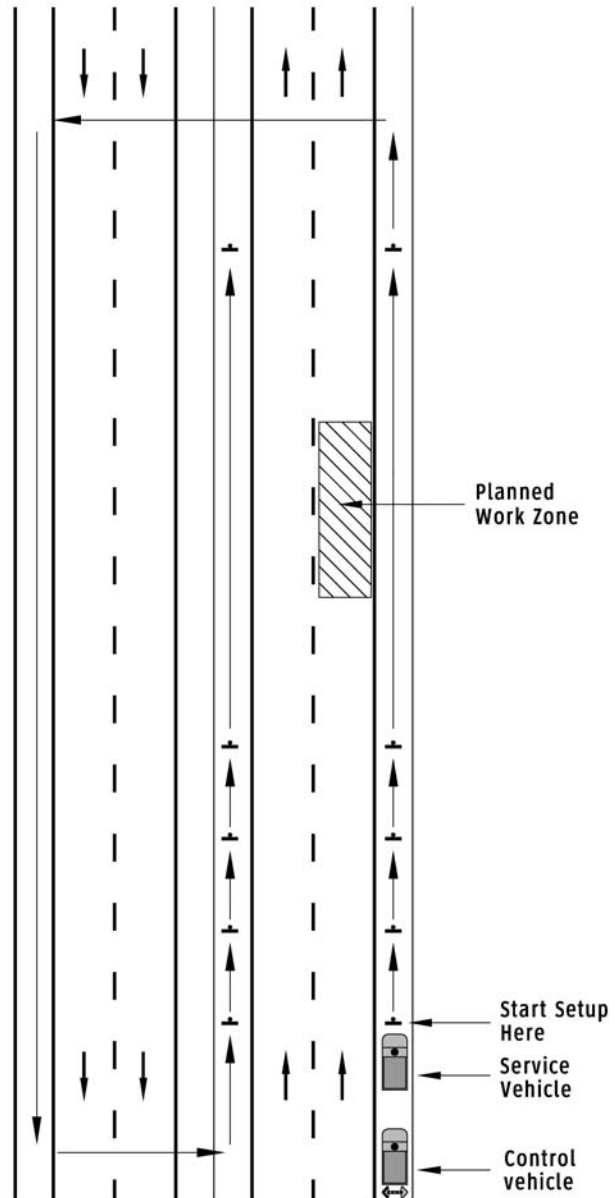

TRAFFIC CONTROL MANUAL 2018

WORK ZONE SETUP (FOUR LANE DIVIDED HIGHWAY)

SEQUENCE:

1. Ensure that all signs are in place on both shoulders.
2. Station a control vehicle with a flashing arrow signal indicating the appropriate direction, in the lane to be closed immediately in advance of the start of the entrance taper.
3. Begin at the entrance taper, laying out all delineation devices to complete the taper.
4. Setup any signs, flashing arrow boards, barricades, or any other traffic control device required within the entrance taper.
5. Continue with traffic flow to complete the delineation and setup of any other signs, flashing arrow boards, barricades or traffic control devices required in the work zone and the termination taper.
6. The control vehicle may be removed following this procedure, if its function is replaced by the signs and traffic control devices installed.

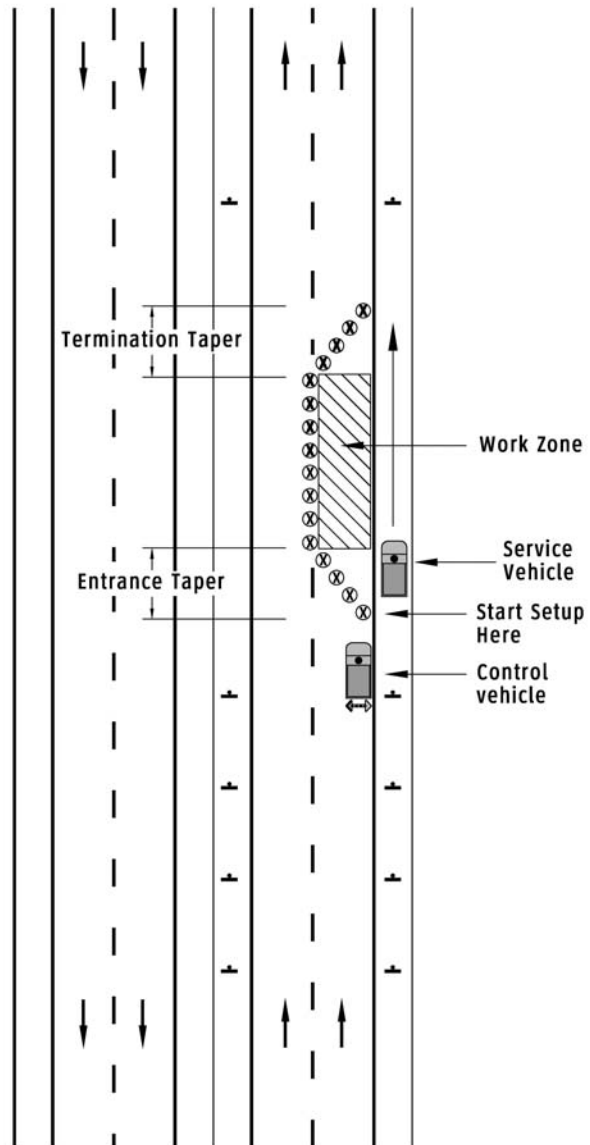

TRAFFIC CONTROL MANUAL 2018

WORK ZONE REMOVAL (FOUR LANE DIVIDED HIGHWAY)

SEQUENCE:

1. Ensure that all work activities have been completed and that all workers, materials, equipment, signs and traffic control devices have been removed from the work zone.
2. Station a control vehicle with a flashing arrow signal indicating the appropriate direction, immediately in advance of the entrance taper for the closed lane.
3. Begin removing the delineation devices around the work zone, beginning at the the termination taper, proceeding against the flow of traffic.
4. The control vehicle shall be removed following completion of step 3 above, and traffic allowed to proceed.

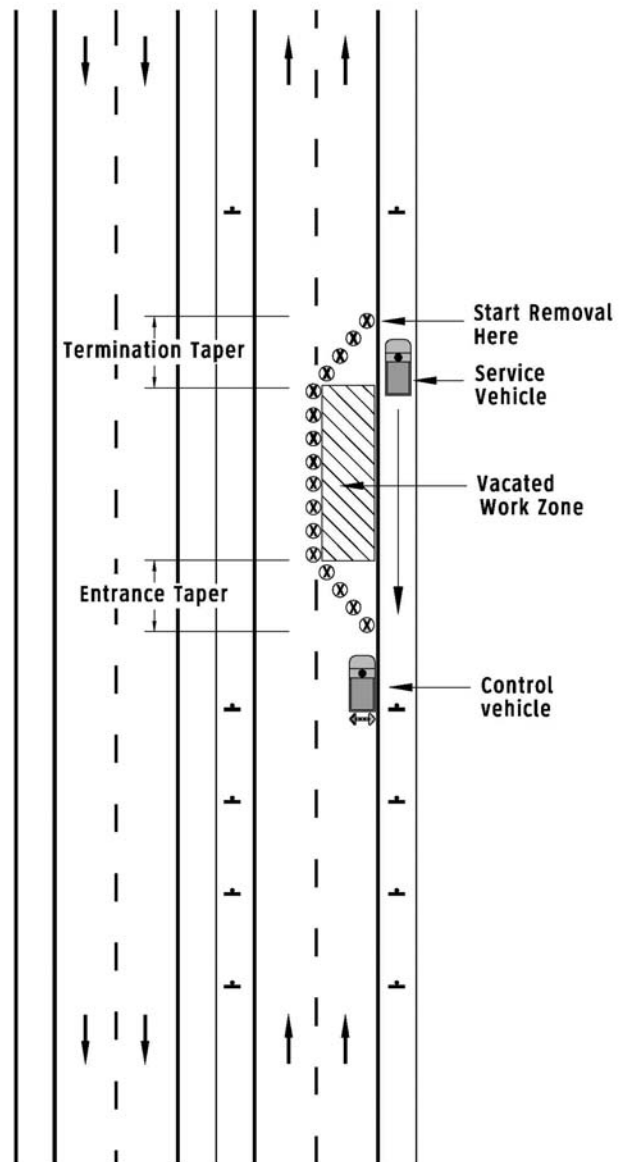

TRAFFIC CONTROL MANUAL 2018

SIGN REMOVAL (FOUR LANE DIVIDED HIGHWAY)

SEQUENCE:

1. Ensure that all work activities have been completed and that all workers, materials, equipment, signs and delineation devices have been removed from the work zone and the lane is open to traffic flow.
2. Station a control vehicle with a flashing arrow signal indicating the appropriate direction, behind the service vehicle, at a distance 'D' as shown in the Construction Distance Table, 799-1 in this manual. This control vehicle shall follow the service vehicle throughout this process at this distance.
3. Begin at the first advance warning sign on the left-hand (ie. median) shoulder of the divided highway, and proceeding with the flow of traffic, remove all remaining signs in this direction.
4. Make two legal turns (at next interchanges or median crossovers) returning to the first advance warning sign located in the right-hand shoulder.
5. Beginning at this advance warning sign, and proceeding with the flow of traffic, remove all remaining signs along this shoulder.

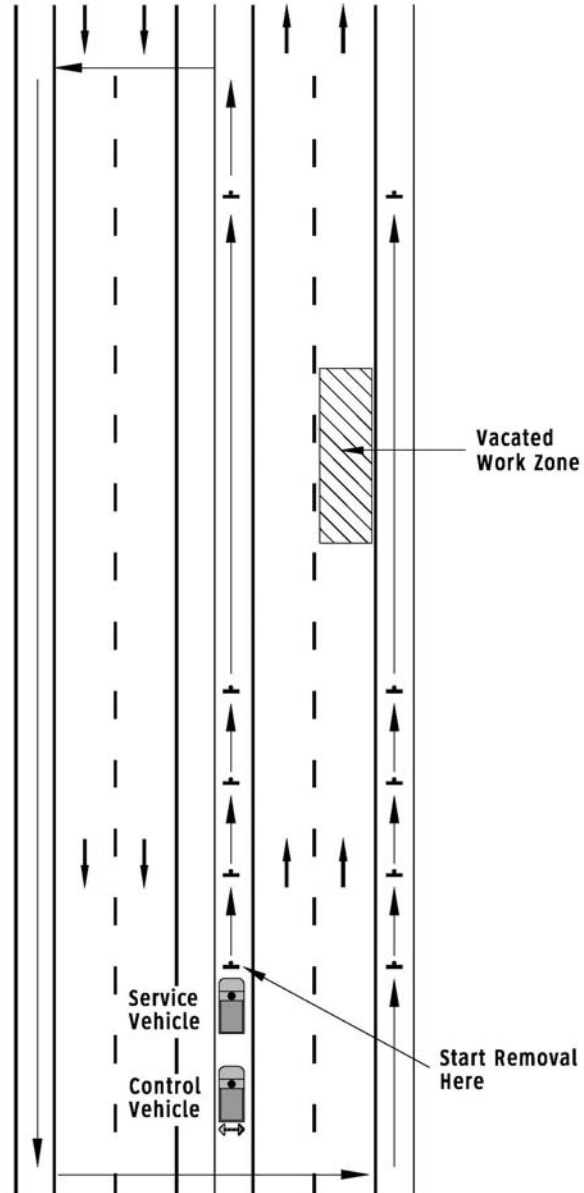

TRAFFIC CONTROL MANUAL 2018

SIGN SETUP 3 or 4 LANE UNDIVIDED HIGHWAY WORK ZONE IN RIGHT LANE OR RIGHT SHOULDER

SEQUENCE:

1. Station a control vehicle with a flashing arrow signal indicating the appropriate direction, behind the service vehicle, at a distance 'D' as shown in the Construction Distance Table, 799-1 in this manual. The control vehicle shall follow the service vehicle throughout this process at this distance.
2. Begin at the first advance warning sign located on right-hand shoulder of the undivided highway and proceeding with the flow of traffic, continue placing all remaining signs along this shoulder in advance of the work zone and after the work zone. Note some signs will be double posted for vehicles to view from the opposite direction.
3. Following placement of the last sign in this direction along the right-hand shoulder, make a legal turn (at next intersection or equipment turnaround) and return to the beginning of the first advance warning sign in the opposite shoulder of the undivided highway.
4. Begin at the first advance warning sign located on opposing road direction shoulder of the undivided highway and proceeding with the flow of traffic, continue placing same signing sequence along this shoulder. All signs included in signing plan should be in place at end.
5. This procedure shall be used for signing any right side lane closure or work activity along a multilane undivided highway. There is a different procedure to be used for delineator layout on a multilane undivided highway depending upon the location of the lane closure.

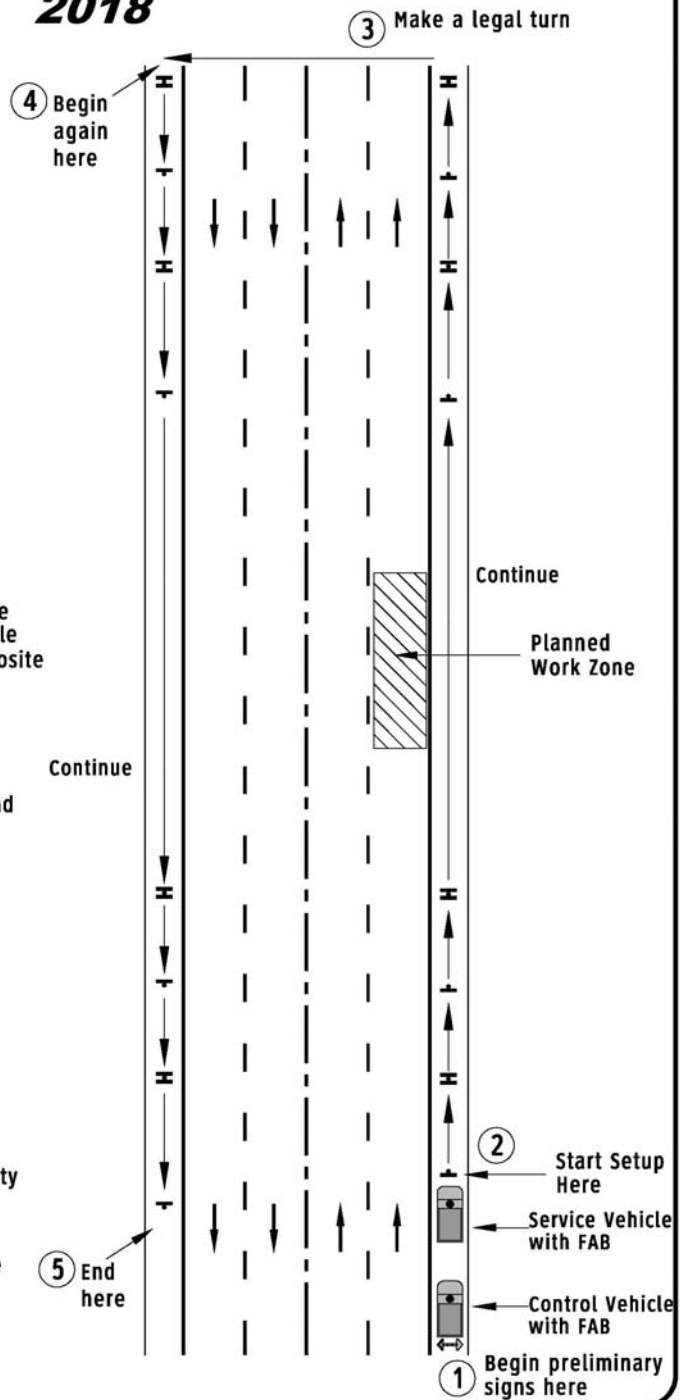

TRAFFIC CONTROL MANUAL 2018

WORK ZONE SETUP 3 OR 4 LANE UNDIVIDED HIGHWAY WORK ZONE IN RIGHT LANE OR RIGHT SHOULDER (PAGE 1 OF 3)

SEQUENCE:

1. Ensure that all signs are in place on both road shoulders as per the Traffic Control Plan and the recommended procedure for Sign Setup. (See Page 46 - 47 Traffic Control Manual)
2. Both Flashing Light Units on Service Vehicle and Control Vehicle are displaying a straight bar (Caution Advised) when preparing for Work Zone setup.

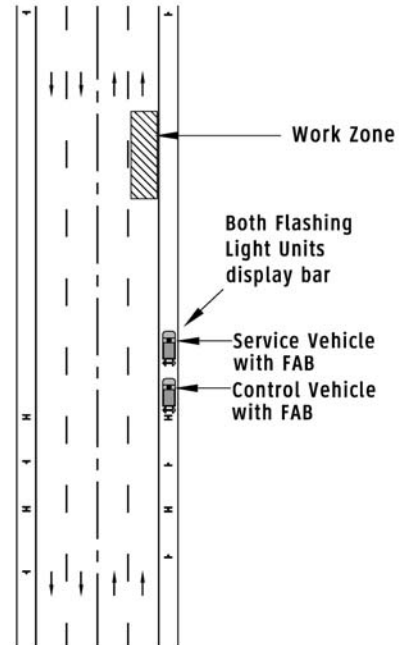

3. Beginning on the right shoulder of the highway on the same side of the road where the Work Zone is located, and approx. halfway between the last sign approaching the work zone and the taper for the work zone choose a gap in traffic and station the vehicle combination in the middle of the lane to be closed. (when safe to do so). These vehicles should be approx. halfway between the last sign and the location where the Entrance Taper will start.
4. As soon as the Control Vehicle blocks a lane it must display the appropriate arrow to direct traffic.

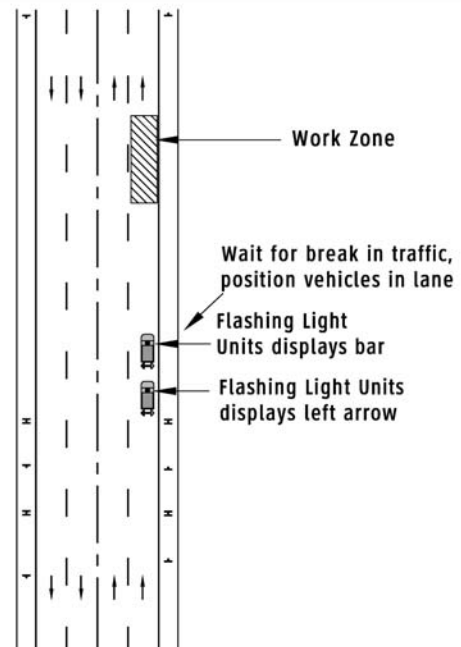

TRAFFIC CONTROL MANUAL 2018

WORK ZONE SETUP 3 OR 4 LANE UNDIVIDED HIGHWAY WORK ZONE IN RIGHT LANE OR RIGHT SHOULDER (PAGE 2 OF 3)

SEQUENCE:

5. Layout Sign TC-6L, "Lane Closed Taper" if required by the Traffic Control Plan.
6. The Service Vehicle takes a position to layout the Entrance Taper.
7. Under the protection of the Control Vehicle, layout the delineators for the Entrance Taper starting at the road shoulder and working toward the centerline. Taper length and delineator spacing should be as per the Construction Distance Table 799-1 of the TCM or Diagram 799-1.

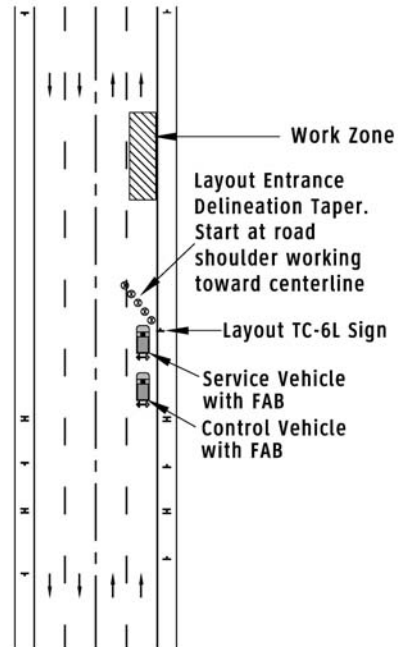

8. Maintaining a safe distance between the Service Vehicle and the Control Vehicle drive through the openings between the delineators on the Entrance Taper to take a position between the Entrance Taper and the Work Zone (approx. mid way).
9. The flashing arrow unit on the Control Vehicle should be positioned so that approaching traffic have the best possible viewing angle.
10. The Control Vehicle maintains position at the Entrance Taper while the Service Vehicle is now free to continue laying out delineators for the Tangent between the tapers, working from the Entrance Taper towards the Termination Taper.

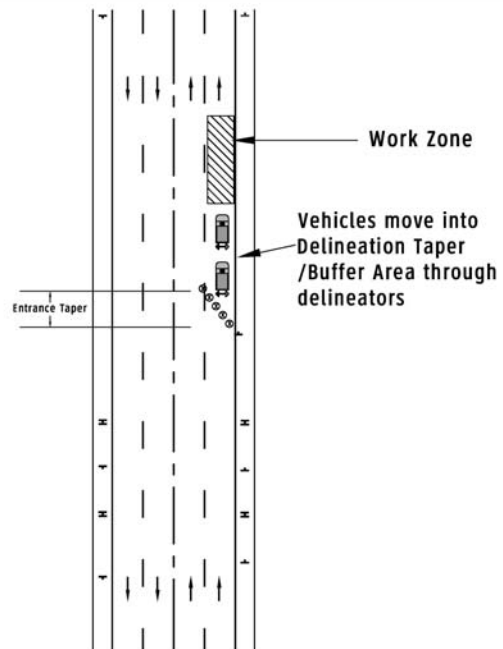

TRAFFIC CONTROL MANUAL 2018

WORK ZONE SETUP 3 OR 4 LANE UNDIVIDED HIGHWAY WORK ZONE IN RIGHT LANE OR RIGHT SHOULDER (PAGE 3 OF 3)

SEQUENCE:

11. If the Traffic Control Plan requires a Termination Taper layout the delineators from the end of the Work Zone Tangent towards the road shoulder.
12. The Control Vehicle may now be replaced with a Stand Alone Flashing Arrow Board if required by the Traffic Control Plan. The Control Vehicle should switch the Flashing Arrow Board to straight bar prior to leaving the Work Zone.

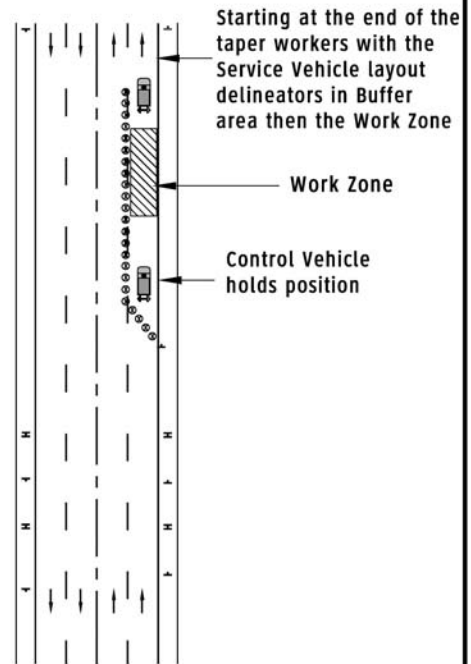

13. Ensure any other traffic control devices are added as required and are properly positioned for best possible viewing by approaching traffic and are working properly.
14. All traffic control devices should now be in place as required by the Traffic Control Plan.
15. The Service Vehicle changes its Flashing Arrow Board to straight bar and exits the Work Zone.

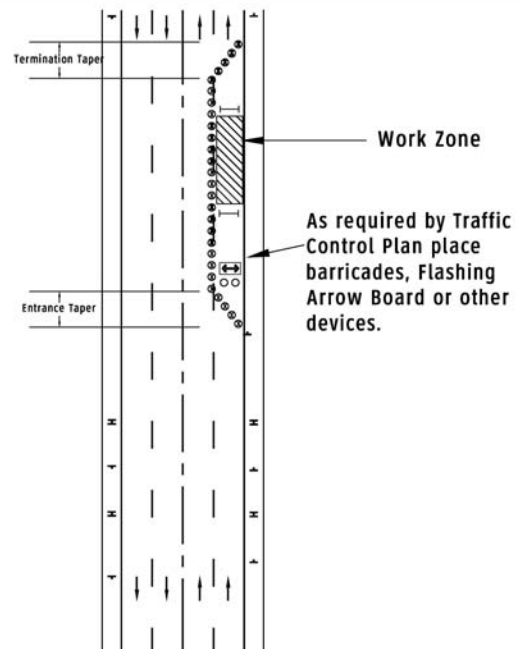

TRAFFIC CONTROL MANUAL 2018

WORK ZONE REMOVAL 3 OR 4 LANE UNDIVIDED HIGHWAY WORK ZONE IN RIGHT LANE OR RIGHT SHOULDER (PAGE 1 OF 3)

SEQUENCE:

1. Ensure that all signs are in place on both road shoulders as per the Traffic Control Plan and the recommended procedure for Sign Setup.
2. At the start of Work Zone removal a Control Vehicle should be in position at the end of the Entrance Taper in advance of the Work Zone. The Flashing Arrow Board should display a left arrow.

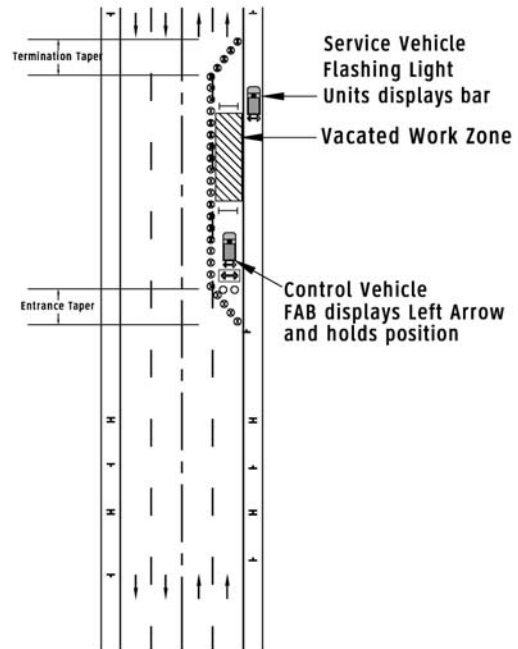

3. Using a Service Vehicle at the Termination Taper or end of the Work Zone remove barricades, traffic control devices and delineation from the end of the Termination Taper towards the Work Zone through to the end of the Entrance Taper. A Service Vehicle with Flashing Light Unit in straight bar mode should be used for this process following the installation and removal procedures on page 46 and 47 of the TCM.

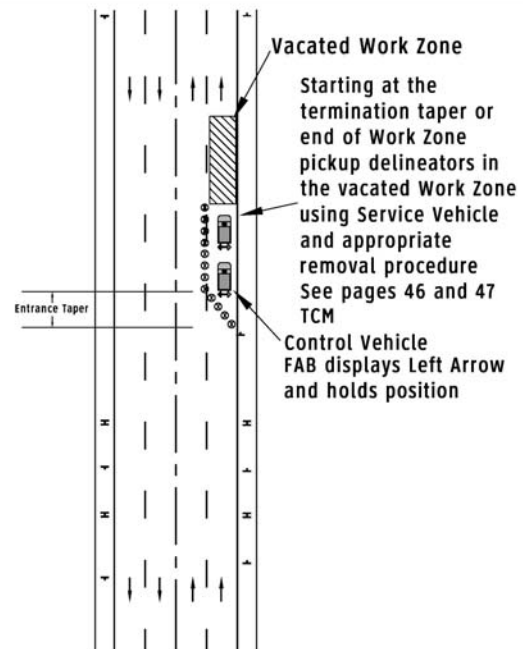

TRAFFIC CONTROL MANUAL 2018

WORK ZONE REMOVAL 3 OR 4 LANE UNDIVIDED HIGHWAY WORK ZONE IN RIGHT LANE OR RIGHT SHOULDER (PAGE 2 OF 3)

SEQUENCE:

4. Move the Service Vehicle in the Entrance Taper to the road side and switch the Flashing Arrow Board to straight bar mode.
5. When safe to do so, choose a gap in traffic and station Control Vehicle in the middle of the closed lane in advance of the Entrance Taper. The Control Vehicle should be positioned approx. halfway between the last sign and the beginning of the Entrance Taper. The Flashing Arrow Board should display Left Arrow.

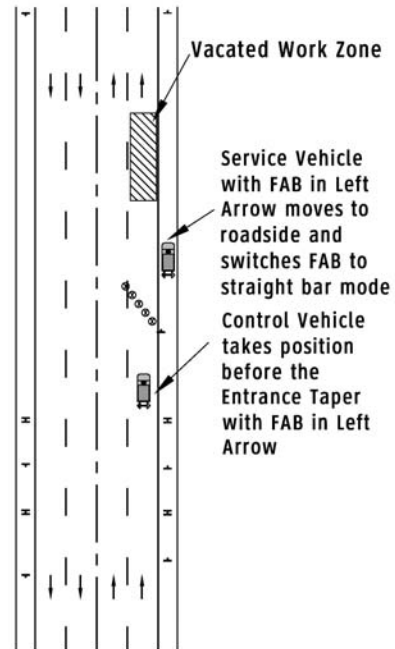

6. Starting at the centerline and working towards the road shoulder remove the Entrance Taper delineation. Use the recommended removal procedures as per pages 46 and 47 of the TCM.
7. Remove the Lane Closed Taper Sign TC-6L if one was used at the beginning of the Entrance Taper.

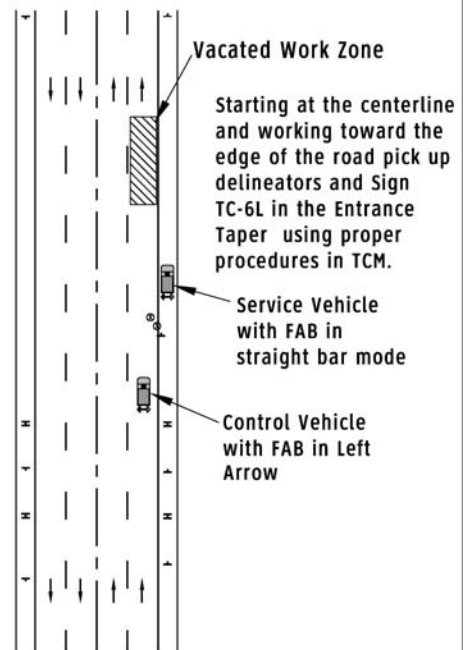

TRAFFIC CONTROL MANUAL 2018

**WORK ZONE REMOVAL
3 OR 4 LANE UNDIVIDED HIGHWAY
WORK ZONE IN RIGHT LANE OR
RIGHT SHOULDER (PAGE 3 OF 3)**

SEQUENCE:

8. When all obstacles and workers are off the road the lead Control Vehicle leaves the travel lane and flashes straight bar on the FAB.
9. Delineators, traffic control devices, vehicles and warning lights are now off the travel lanes and normal traffic flow has been re-established.

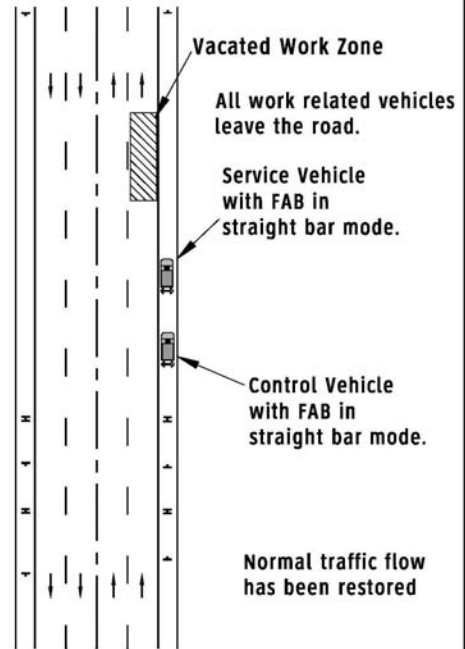

TRAFFIC CONTROL MANUAL 2018

SIGN REMOVAL 3 OR 4 LANE UNDIVIDED HIGHWAY WORK ZONE IN RIGHT LANE

SEQUENCE:

1. Ensure that all work activities have been completed and that all workers, materials, equipment, delineation signs and traffic control devices have been removed from the work site as per the procedure set out for removing delineators on multilane highways.
2. Beginning on the right shoulder of the road, on the same side of the road and next to the Work Zone, start driving forward with the flow of traffic away from the work area picking up the signs on the right shoulder of the road.
3. Following removal of the last sign in this direction make a safe and legal turn (at next intersection or equipment turnaround) and return to the beginning of the first advance warning sign in the opposite shoulder of the work zone on the undivided highway.
4. Beginning at the first advance warning sign located on the opposing road direction shoulder proceed with the flow of traffic and continue removing all signage along this shoulder till the end of the sequence.
5. Following removal of the last sign in this direction make a safe and legal turn (at next intersection or equipment turnaround) and return to the beginning of the first advance warning sign in the opposite shoulder of the undivided highway.
6. Beginning at the first advance warning sign located on the same side and approaching the work zone, proceed with the flow of traffic and remove the final portion of the signing sequence up to the original work zone. All signs should now be removed in both directions.

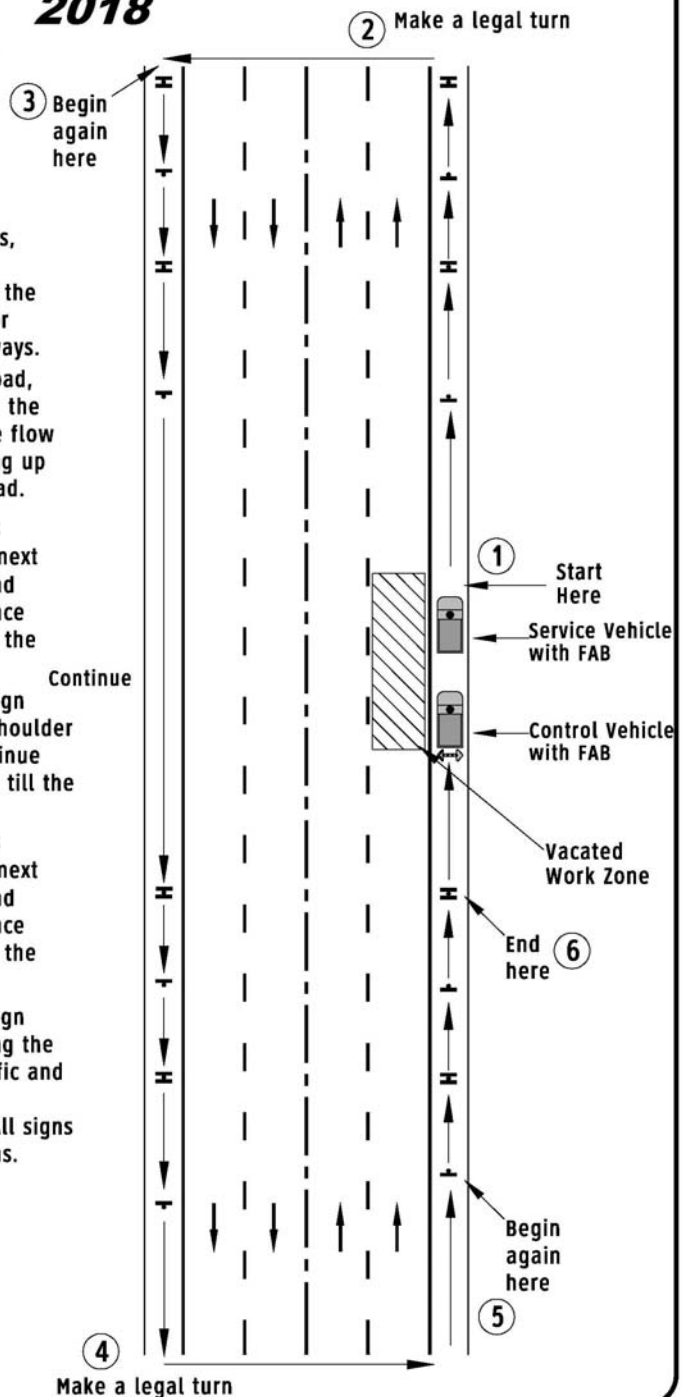

TRAFFIC CONTROL MANUAL 2018

SIGN SETUP 3 OR 4 LANE UNDIVIDED HIGHWAY WORK ZONE IN LEFT LANE

SEQUENCE:

1. Station a control vehicle with a flashing arrow signal indicating the appropriate direction, behind the service vehicle, at a distance 'D' as shown in the Construction Distance Table, 799-1 in this manual. The control vehicle shall follow the service vehicle throughout this process at this distance.
2. Begin placing advanced warning signage as described on page 4 of the TCM and shown on Layouts 740-1 to 740-4.
3. Following advanced warning signage placement begin by driving past the work zone with the flow of traffic (away from the work zone) laying out the signage required by the sign plan on the right shoulder of the road.
4. Following placement of the last sign in this direction make a safe and legal turn (at next intersection or equipment turnaround) and return to the beginning of the first advance warning sign in the opposite shoulder of the work zone on the undivided highway.
5. Beginning at the first advance warning sign located on the opposing road direction shoulder proceed with the flow of traffic and continue placing the required signing sequence along this shoulder till the end of the sequence.
6. Following placement of the last sign in this direction make a safe and legal turn (at next intersection or equipment turnaround) and return to the beginning of the first advance warning sign in the opposite shoulder of the undivided highway.
7. Beginning at the first advance warning sign located on the same side and approaching the work zone, proceed with the flow of traffic and place the final portion of the signing sequence. All signs should now be posted in both directions. Follow procedure for setting up delineation for left lane of a multilane undivided highway.

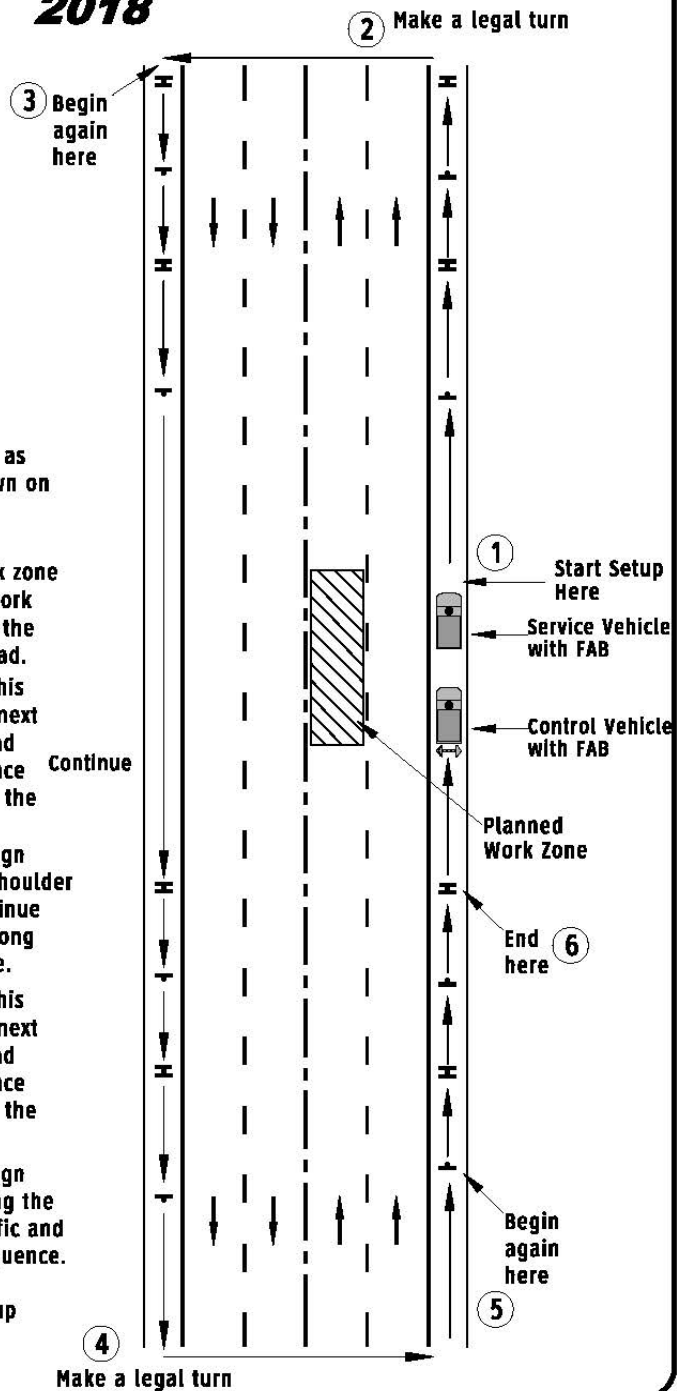

TRAFFIC CONTROL MANUAL 2018

WORK ZONE SETUP 3 OR 4 LANE UNDIVIDED HIGHWAY WORK ZONE IN LEFT LANE (PAGE 1 OF 3)

SEQUENCE:

1. Ensure that all signs are in place on both road shoulders as per the Traffic Control Plan and the recommended procedure for Sign Setup. (see page 64 of TCM)
2. Both Flashing Light Units on both Vehicles are displaying a straight bar (Caution Advised) when preparing for Work Zone setup.

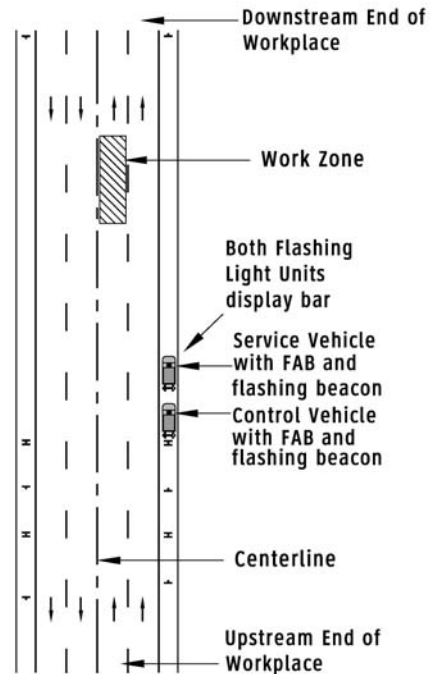

3. Beginning on the right shoulder of the highway on the same side of the road where the Work Zone is located, choose a gap in traffic and station the vehicle combination in the middle of the lane to be closed, to protect the workers who will layout the Entrance Taper. (when safe to do so). The upstream vehicle with the Flashing Light Unit should be approx. halfway between the last sign and where the Entrance Taper will start.
4. As soon as the Control Vehicle blocks a lane it must display the appropriate arrow to direct traffic.

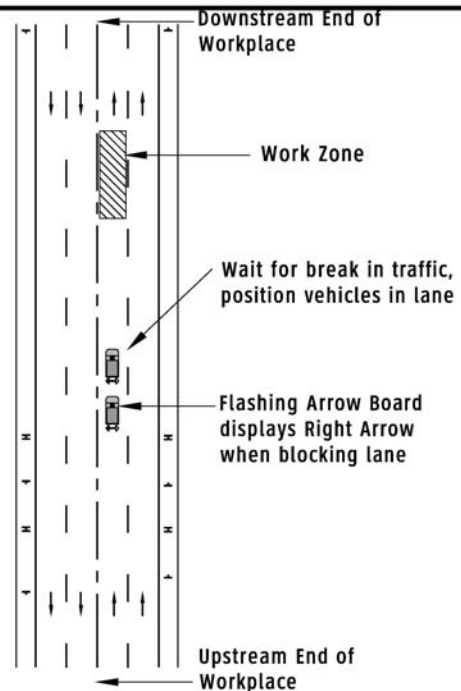

TRAFFIC CONTROL MANUAL 2018

**WORK ZONE SETUP
3 OR 4 LANE UNDIVIDED HIGHWAY
WORK ZONE IN LEFT LANE
PAGE 2 OF 3**

SEQUENCE:

5. Layout Sign TC-6R, "Lane Closed Taper" if required by the Traffic Control Plan.
6. The Service Vehicle takes a position to layout the Entrance Taper.
7. Under the protection of the Control Vehicle with the Flashing Arrow Unit, layout the delineators for the Entrance Taper starting at the centerline and working toward the lane line. Taper length and delineator spacing should be as per the Construction Distance Table on TCM Diagram 799-1. Also layout delineators on the centerline for a distance similar to the Entrance Taper.

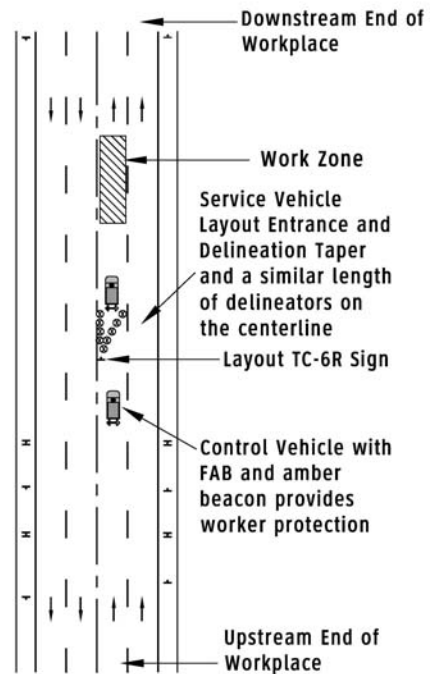

8. The Control Vehicle drives through the openings between the delineators on the Entrance Taper to take a position at the upstream end of the Entrance Taper and the Work Zone upstream of the Service Vehicle.
9. The Flashing Arrow Unit on the Vehicle at the Entrance Taper should be positioned so that approaching traffic have the best possible viewing angle.
10. The Control Vehicle maintains position at the Entrance Taper while the Service Vehicle is now free to support workers in laying out the rest of the delineators. The Service vehicle drives downstream in the closed lane to layout delineators for the Tangents between the tapers, working from the Entrance Taper towards the Termination Taper.

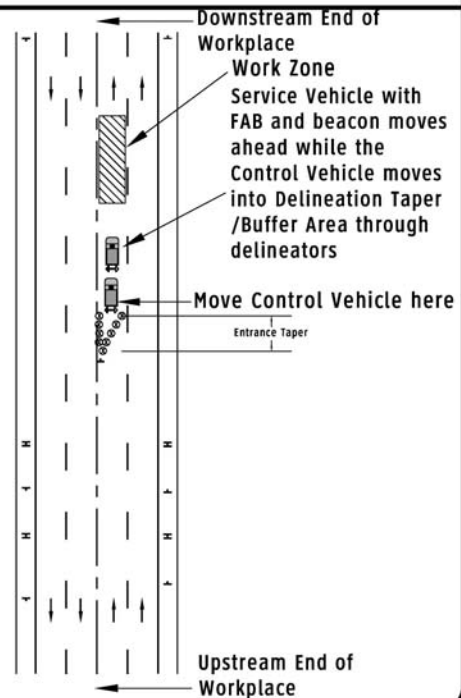

TRAFFIC CONTROL MANUAL 2018

**WORK ZONE SETUP
3 OR 4 LANE UNDIVIDED HIGHWAY
WORK ZONE IN LEFT LANE
PAGE 3 OF 3**

SEQUENCE:

11. Starting on both the lane line and centerline layout delineators from the last positioned delineator through the Work Zone towards the downstream end where the Termination Taper will also be constructed. Delineators should be offloaded from the back of the Vehicle and work behind the downstream Vehicle. Delineator spacing standards and taper distances should be taken from the Construction Distance Table TCM Figure 799-1.

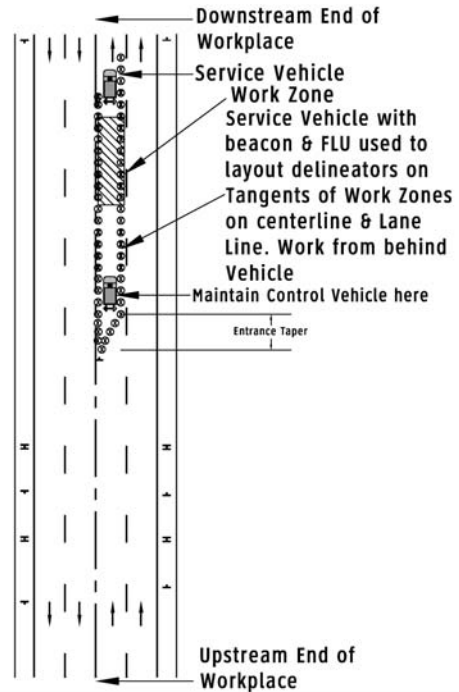

12. The downstream Service Vehicle may now be positioned close to the boundary between the Termination Taper and the Work Zone to protect the work area from the downstream end or be replaced by a Flashing Arrow Board if required by the Traffic Control Plan.
13. The upstream Control Vehicle may be replaced by a Flashing Arrow Board if required by the Traffic Control Plan.
14. Ensure any other traffic control devices are added as required, properly positioned for best possible viewing by approaching traffic and are working properly.
15. All traffic control devices should now be in place as required by the Traffic Control Plan.

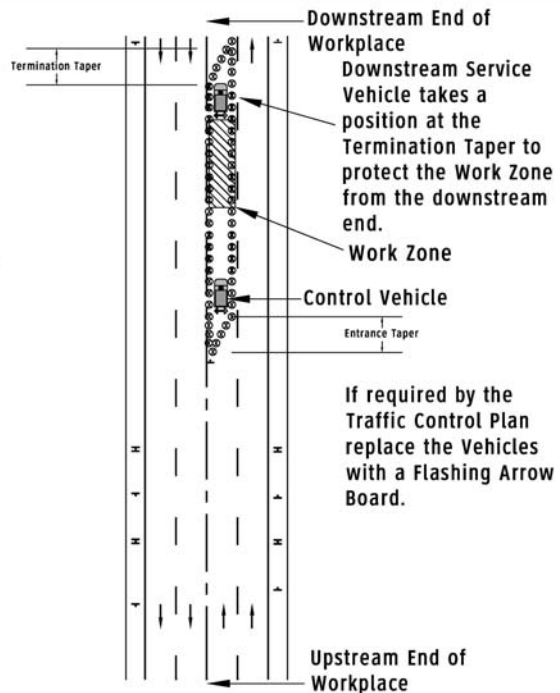

TRAFFIC CONTROL MANUAL 2018

WORK ZONE REMOVAL 3 OR 4 LANE UNDIVIDED HIGHWAY WORK ZONE IN LEFT LANE PAGE 1 OF 3

SEQUENCE:

1. Ensure that all signs are in place on both road shoulders as per the Traffic Control Plan and the recommended procedure for sign setup.
2. At the start of this Work Zone Removal procedure a vehicle with a flashing amber beacon and a Flashing Arrow Board is in position at the boundary between the Entrance Taper and the Work Zone. the Flashing Arrow Board is displaying an Arrow to traffic approaching the Work Zone from the upstream end of the workplace.
3. A Service Vehicle with a flashing arrow board and a Flashing Light Unit in straight bar mode is in position at the termination taper.

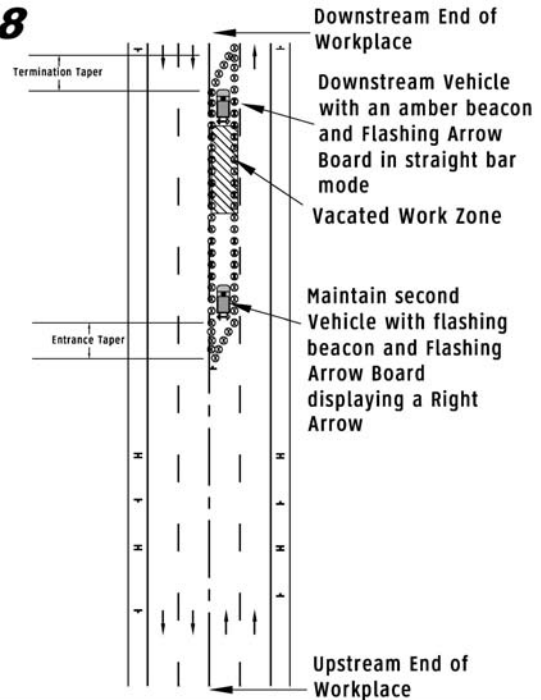

4. When all work is complete in the Work Zone and when it is safe to open the work zone hold a "tool box meeting" with all vehicle drivers and workers to discuss the methods to be used to communicate hazards and prevent injuries that could result from working behind vehicles that will reverse.
5. Move the downstream Service Vehicle from the Termination Taper into the middle of the closed lane, downstream of the Termination Taper to protect workers who will pick up the taper delineation.

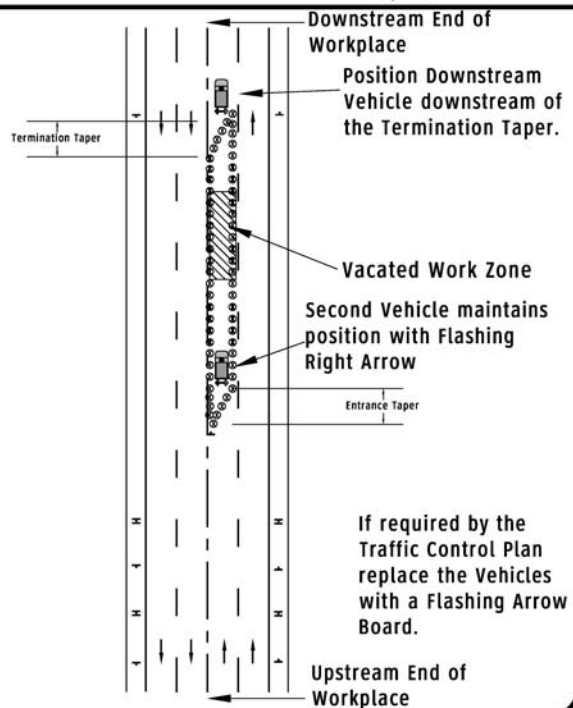

TRAFFIC CONTROL MANUAL 2018

**WORK ZONE REMOVAL
3 OR 4 LANE UNDIVIDED HIGHWAY
WORK ZONE IN LEFT LANE
PAGE 2 OF 3**

SEQUENCE:

6. Supported by the downstream Service Vehicle that will move and reverse within the closed lane, workers (working at the back of the (stopped) Service Vehicle) pick up the delineators in the Termination Taper and Work Zone working from the downstream to the upstream direction. Both the centerline and lane line delineators are picked up at approximately the same time and rate.

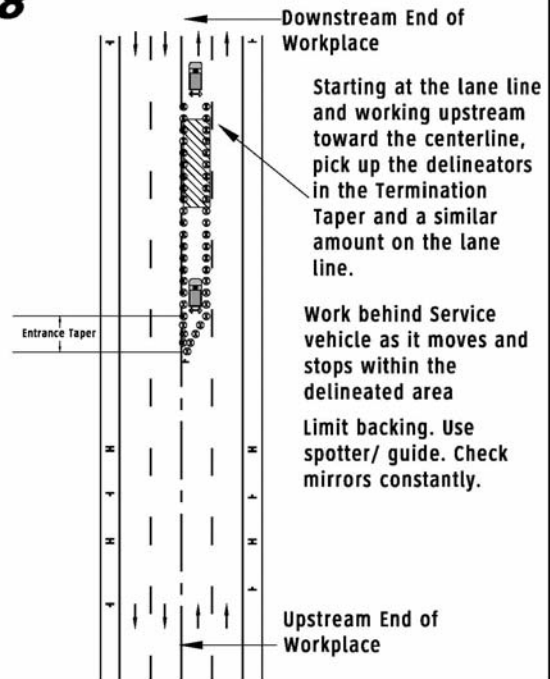

7. When all delineators have been removed up to the Entrance Taper prepare to move the Service Vehicle for the task of supporting the removal of the Entrance Taper.

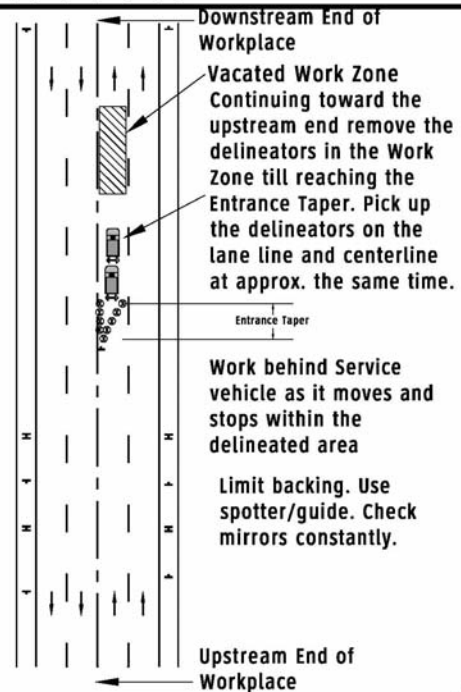

TRAFFIC CONTROL MANUAL 2018

WORK ZONE REMOVAL 3 OR 4 LANE UNDIVIDED HIGHWAY WORK ZONE IN LEFT LANE (PAGE 3 OF 3)

SEQUENCE:

8. When safe to do so, position Control Vehicle with a flashing beacon and a Flashing Arrow Board showing Right Arrow in the middle of the closed lane. This Control Vehicle should be approximately halfway between the last sign and the beginning of the Entrance Taper.
9. When the Control Vehicle is in Position remove the remaining delineators on the taper and the centerline starting at the downstream end working upstream. Use the downstream Service Vehicle remaining in position to complete this removal process.

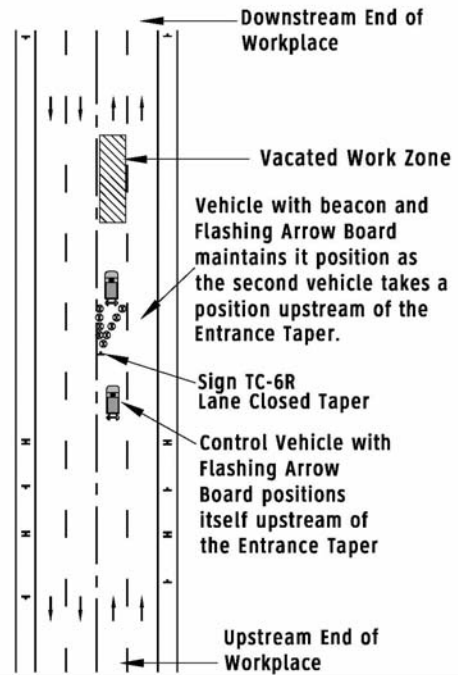

10. Pick up the Sign TC-6R Lane Closed Taper when all delineators have been removed.
11. When all obstacles and workers are off the travel lane, the vehicle(s) leave the travel lane. All delineators, warning lights and vehicles are off the roadway and normal traffic flow may resume.
12. Continue to remove the signage from the lane closure operation by the recommended procedure.

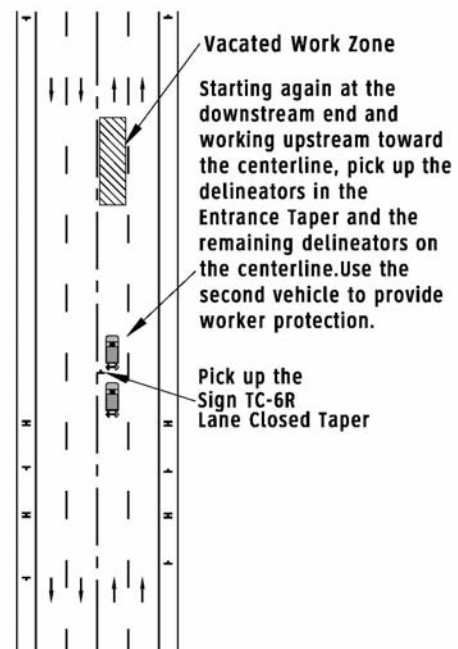

TRAFFIC CONTROL MANUAL 2018

SIGN REMOVAL 3 OR 4 LANE UNDIVIDED HIGHWAY WORK ZONE IN LEFT LANE

SEQUENCE:

1. Ensure that all work activities have been completed and that all workers, materials, equipment, delineation signs and traffic control devices have been removed from the work site as per the procedure set out for removing delineators on multilane highways.
2. Beginning on the shoulder of the road, on the opposite side of the road and in advance of the Work Zone, start driving forward with the flow of traffic toward the work zone picking up the signs on the right shoulder of the road.
3. Following removal of the last sign in this direction make a safe and legal turn (at next intersection or equipment turnaround) and return to the beginning of the first advance warning sign approaching the work zone on the undivided highway.
4. Beginning at the first advance warning sign located on the same side and approaching the work zone, proceed with the flow of traffic and remove the final portion of the signing sequence up to the original work zone. All signs should now be removed in both directions.

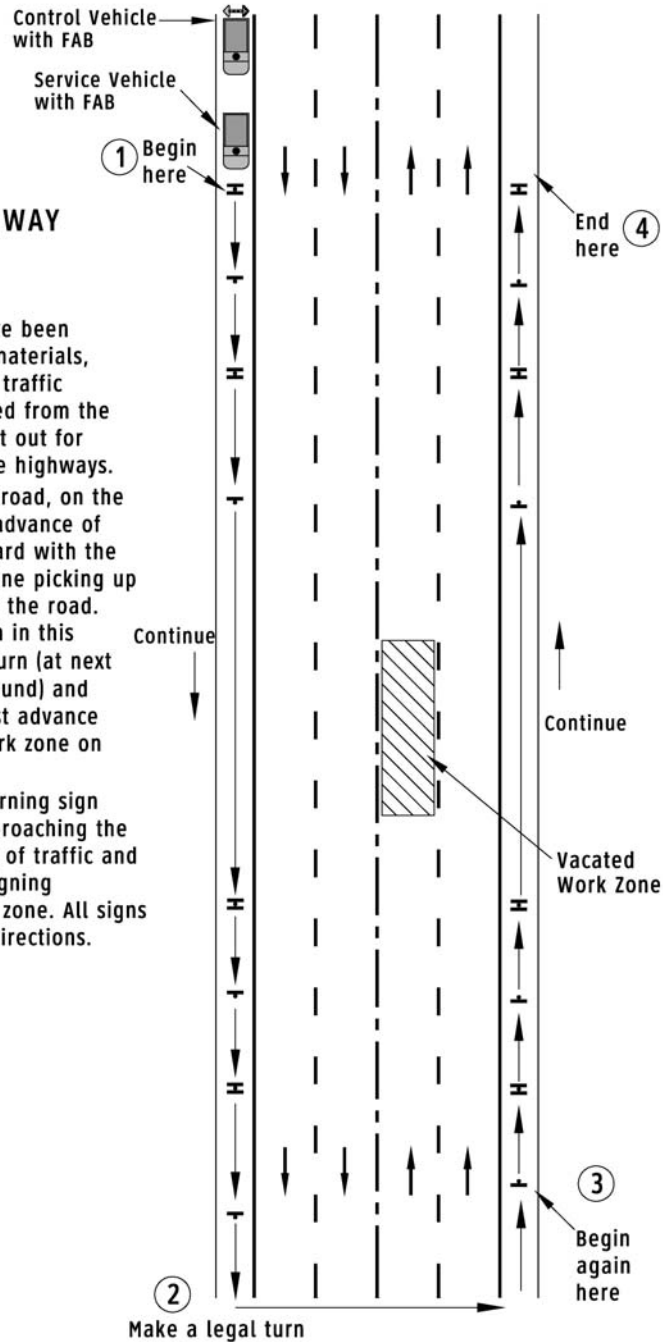

11.0 TYPICAL CONSTRUCTION SIGNS

TRAFFIC CONTROL MANUAL 2018



TC-1
90 X 90cm
Construction
Ahead



TC-2
90 X 90cm
Road
Work



TC-3
90 X 90cm
Surveyor



TC-4
90 X 90cm
Construction
Ends



TC-5R
90 X 90cm
Temporary
Lane Closed
Ahead



TC-5L
90 X 90cm
Temporary
Lane Closed
Ahead



TC-6L or 6R
90 X 90cm
Lane Closed
Taper



TC-7L or 7R
60 X 120cm
Lane Closure
Arrow



TC-10
90 X 90cm
Detour
Ahead



TC-10A
90 X 90cm
Detour
Ahead



TC-11
45 X 60cm
Detour Route
Markers



TC-11L or 11R
45 X 60cm
Detour Route
Markers

**TRAFFIC CONTROL MANUAL
2018**



TC-13L or 13R
90 X 90cm
Road
Diversion



TC-15L or 15R
90 X 90cm
Road
Realignment



TC-21
90 X 90cm
Flagperson
(Traffic Control
Person Ahead)



TC-30
90 X 90cm
Checkerboard



TC-30L or 30R
90 X 90cm
Checkerboard



TC-47
90 X 90cm
Grooved
Pavement



TC-48
90 X 90cm
Soft Shoulder



TC-49
90 X 90cm
Pavement
Drop Off



TC-112
90 X 90cm
Be Prepared
To Stop



TC-62
90 X 30cm
Construction
Marker



TC-62A
60 X 22.5cm
Construction
Marker



TC-64A
20 X 240cm
Construction
Barricade

**TRAFFIC CONTROL MANUAL
2018**



TC-64C
30 X 180cm
Construction
Barricade



TC-64B
30 X 180cm
Construction
Barricade



TC-130
75 X 75cm
Grader



TC-139
75 X 60cm
Blasting
Operations



TC-150
90 X 75cm
Paint Crew
Ahead



TC-151
90 X 90cm
Loose Gravel



TC-152
90 X 90cm
Fresh Tar



TC-165
45 X 45cm
Stop/Slow
Paddle



TC-166
60 X 75cm
Temporary
Striping



TC-167
60 X 60cm
Temporary
Striping



TC-200
120 X 120cm
End of
Construction



TC-304
75 X 150cm
DO NOT PASS
WHEN FLASHING

TRAFFIC CONTROL MANUAL 2018



TC-300
90 X 90cm
Emergency
Scene
Ahead



TC-301
90 X 90cm
Incident
Ahead



TC-CZ1
90 X 120cm
Construction
Begins



TC-CZ2
90 X 60cm
Construction
Ends



TC-CZ3
120 X 244cm
Fines Doubled
(Contractor)



TC-CZ4
90 X 90cm
Fines Doubled
(Maintenance)



TC-203
60 X 60cm
Snow
Equipment
Working



TC-204
60 X 60cm
Blower



TC-205
60 X 60cm
Loader



TC-206
90 X 90cm
Maintenance
Operations

TRAFFIC CONTROL MANUAL 2018



SPEED 50km/h

TC-302
75cm X 75cm



SPEED 50km/h

TC-303
75cm X 75cm



TC-304
75 X 150cm
DO NOT PASS
WHEN FLASHING



SPEED
60 - 100km/h

TC-302A
90cm X 90cm



SPEED
60 - 100km/h

TC-303A
90cm X 90cm



TC-130
75cm X 75cm
GRADER AHEAD



SPEED 50km/h

RB-302
60cm X 90cm

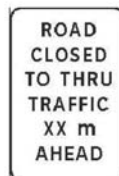

SPEED
60 - 100km/h

RB-302A
90cm X 120cm



RB-23Z
60cm X 90cm

NOTE:

THE NUMBERS ASSIGNED TO THE ABOVE SIGNS ARE FOR GOVERNMENT OF NL REFERENCE ONLY. THESE REFERENCE NUMBERS ARE SUBJECT TO CHANGE AS THE MUTDC UPDATES IT'S MANUAL

TRAFFIC CONTROL MANUAL 2018

**ROAD
CONSTRUCTION**
NEXT ___ km

TC-207
122cm X 244cm

**ZIPPER
MERGE
AHEAD**

SPEED 50km/h



SPEED
60 - 100km/h

TC-208A
75cm X 60cm

TC-208B
90cm X 90cm

**ALTERNATE
MERGE
XX m
AHEAD**

TC-209
90cm X 75cm

**USE
BOTH
LANES**

TC-210
75cm X 60cm

**BEGIN
MERGE**

TC-211
30cm X 60cm



TC-212
90cm X 90cm



TC-213
90cm X 90cm

NOTE:

THE NUMBERS ASSIGNED TO THE ABOVE SIGNS ARE FOR GOVERNMENT OF NL REFERENCE ONLY. THESE REFERENCE NUMBERS ARE SUBJECT TO CHANGE AS THE MUTDC UPDATES IT'S MANUAL

TRAFFIC CONTROL MANUAL 2018



TC-214
90cm X 90cm



TC-214T
30cm X 75cm



TC-215
75cm X 60cm

NOTE:

THE NUMBERS ASSIGNED TO THE ABOVE SIGNS ARE FOR GOVERNMENT OF NL REFERENCE ONLY. THESE REFERENCE NUMBERS ARE SUBJECT TO CHANGE AS THE MUTDC UPDATES IT'S MANUAL

12.0 TYPICALL CONTROL VEHICLE LAYOUTS

TRAFFIC CONTROL MANUAL 2018

CONTROL VEHICLE APPLICATION

THE CONTROL VEHICLE MAY BE USED DURING CONSTRUCTION OR MAINTENANCE ACTIVITIES WHERE THE NATURE OF THE WORK BEING PERFORMED IS CONSIDERED VERY SHORT TERM OR SHORT TERM IN NATURE.

A CONTROL VEHICLE MAY ALSO BE USED DURING SNOW CLEANUP OPERATIONS ON ANY HIGHWAY, AS SHOWN IN THE DRAWINGS ON PAGES 81 and 82 for Control Vehicle Applications for Snow Clearing Operations.

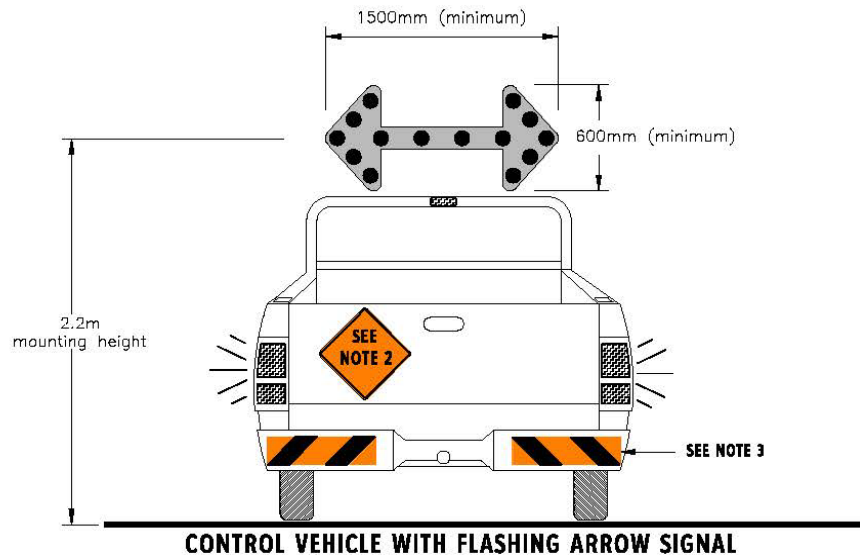

1. WHEN IN OPERATION, THE CONTROL VEHICLE SHALL DISPLAY ALL WARNING LIGHTS IN FLASHING MODE AND THE APPROPRIATE FLASHING ARROW SIGNALS REQUIRED TO DIRECT TRAFFIC.
2. FOR SNOW CLEANUP OPERATIONS ATTACH THE APPROPRIATE SIGN, TC-204 (BLOWER OR TC-205 (LOADER) TO THE BACK OF THE CONTROL VEHICLE. FOR OTHER SITUATIONS SUCH, AS POTHOLE PATCHING, USE TC-215 (FLAGPERSON) SIGN.
3. HAZARD SIGNS, AS SHOWN, SHALL BE ATTACHED TO THE BUMPERS OF THE CONTROL VEHICLES. THESE HAZARD MARKERS SHALL BE MADE FROM HIGH INTENSITY REFLECTIVE ORANGE MATERIAL WITH BLACK STRIPES.

TRAFFIC CONTROL MANUAL 2018

VERY SHORT TERM WORK - LOW SPEED OR LOW VOLUME
SPEED LIMIT 60 km/h OR LESS
TWO WAY TRAFFIC

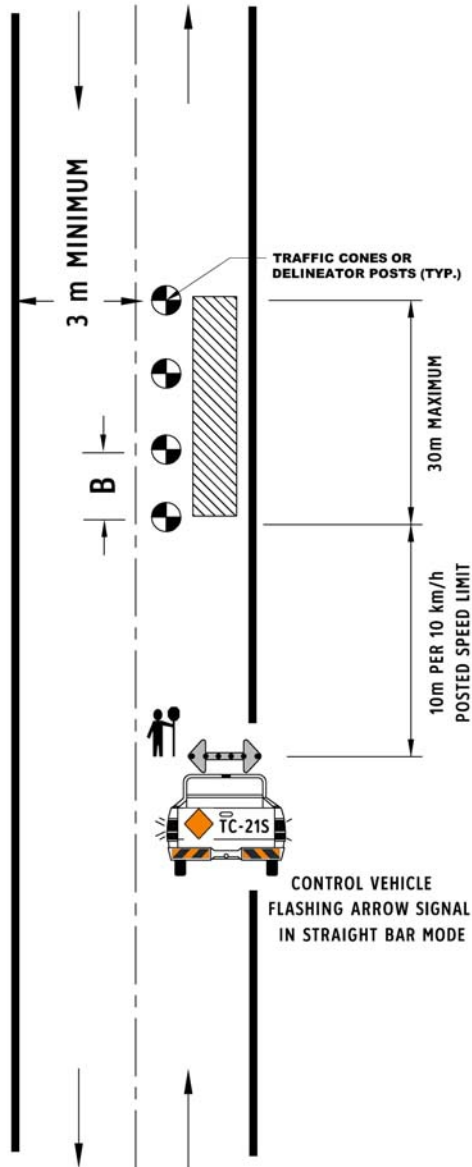

- WORK ACTIVITY ON DIVIDED HIGHWAYS OR ANY OTHER HIGHWAY WITH A SPEED LIMIT GREATER THAN 60 km/h, IS CLASSIFIED AS SHORT TERM WORK (HIGH SPEED OR HIGH VOLUME). REFER TO LANES CLOSED DIAGRAMS IN SECTION 752, AND SIGN ACCORDINGLY.
- WORK ACTIVITIES SHALL OCCUR DURING DAYLIGHT HOURS AND NOT DURING CONDITIONS OF LIMITED VISIBILITY (Eg. FOG).
- REFER TO CONSTRUCTION DISTANCE TABLE 799-1 FOR SPACING.
- FLAGPERSON TO BE LOCATED WHERE MOST APPROPRIATE FOR THE TYPE OF WORK.
- A CRASH ATTENUATOR MAYBE ADDED TO THIS SETUP.

TRAFFIC CONTROL MANUAL 2018

SHORT TERM WORK - LOW SPEED OR LOW VOLUME
SPEED LIMIT 60 km/h OR LESS
TWO WAY TRAFFIC

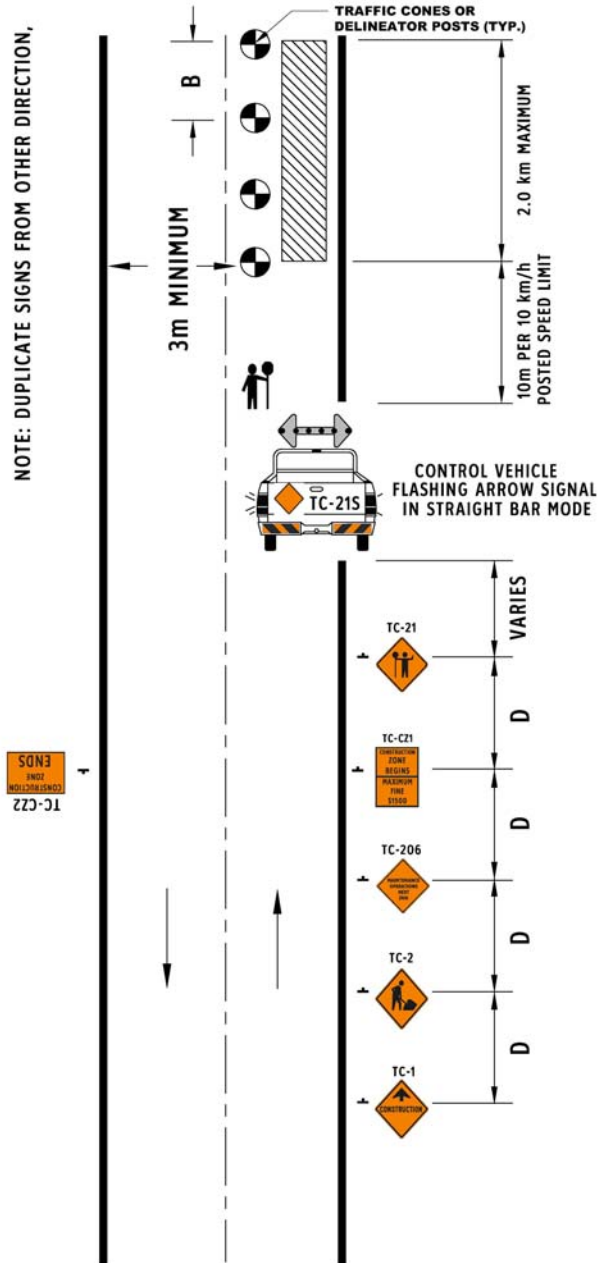

- WORK ACTIVITY ON DIVIDED HIGHWAYS OR ANY OTHER HIGHWAY WITH A SPEED LIMIT GREATER THAN 60 km/h OR HIGHER TRAFFIC VOLUMES, IS CLASSIFIED AS SHORT TERM WORK (HIGH SPEED OR HIGH VOLUME). REFER TO LANE CLOSED DIAGRAMS IN SECTION 752, AND SIGN ACCORDINGLY.
- WORK ACTIVITIES SHALL OCCUR DURING DAYLIGHT HOURS AND NOT DURING CONDITIONS OF LIMITED VISIBILITY (Eg. FOG).
- REFER TO CONSTRUCTION DISTANCE TABLE 799-1 FOR SPACING.
- THE CASE FOR A SECOND FLAGPERSON MAY BE REQUIRED. THIS IS TO BE CONSIDERED ON A CASE BY CASE BASIS.
- FLAGPERSON(S) TO BE LOCATED WHERE MOST APPROPRIATE FOR THE TYPE OF WORK.
- A CRASH ATTENUATOR MAYBE ADDED TO THIS SETUP.

TRAFFIC CONTROL MANUAL 2018

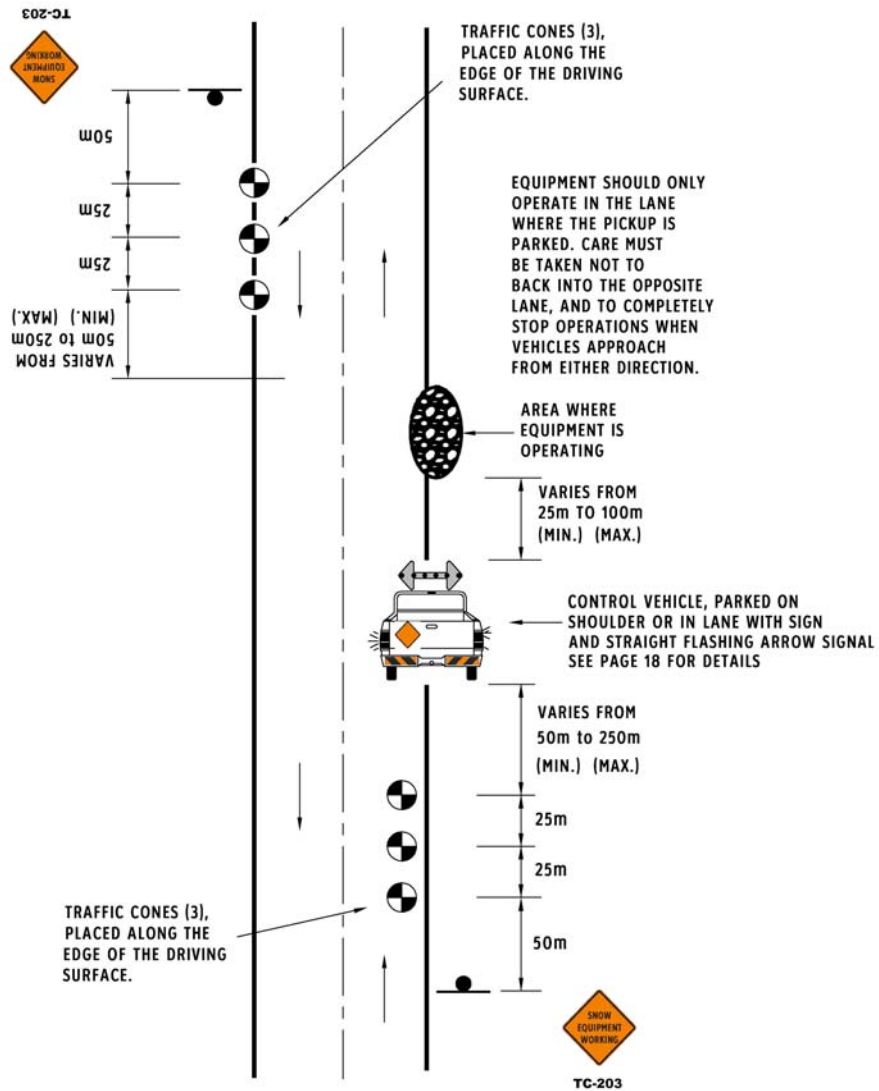

TRAFFIC CONTROL MANUAL 2018

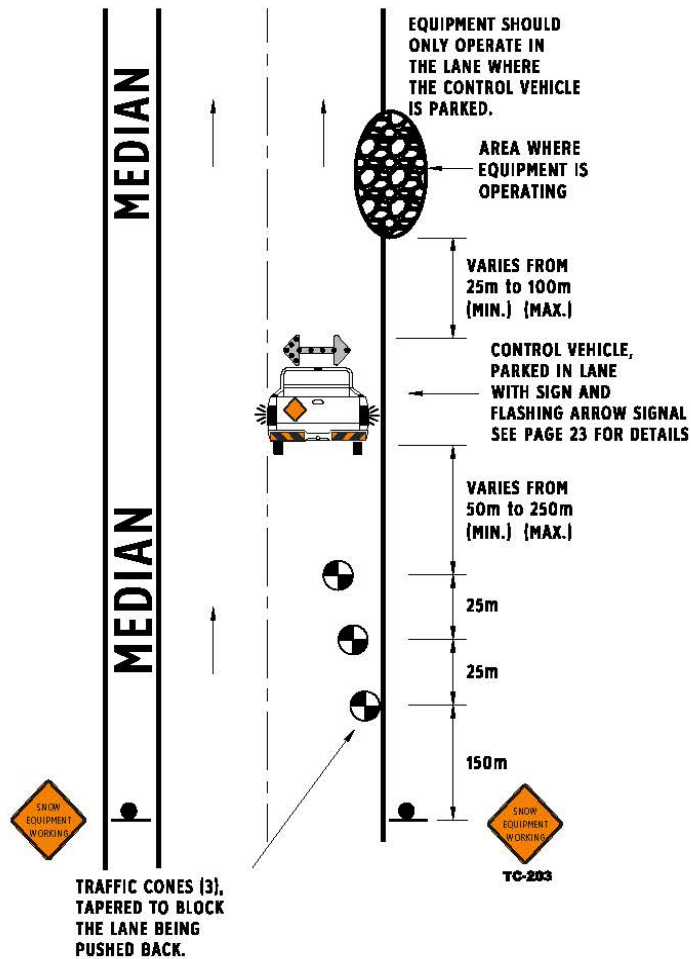

NOTE:

WHEN PUSHING BACK SNOW IN THE CENTRE (LEFT) LANE, THE CONING AND CONTROL VEHICLE SETUP IS A MIRROR IMAGE OF THE SETUP SHOWN ABOVE.

TRAFFIC CONTROL MANUAL 2018

**FIGURE 1
TWO-WAY HIGHWAY**

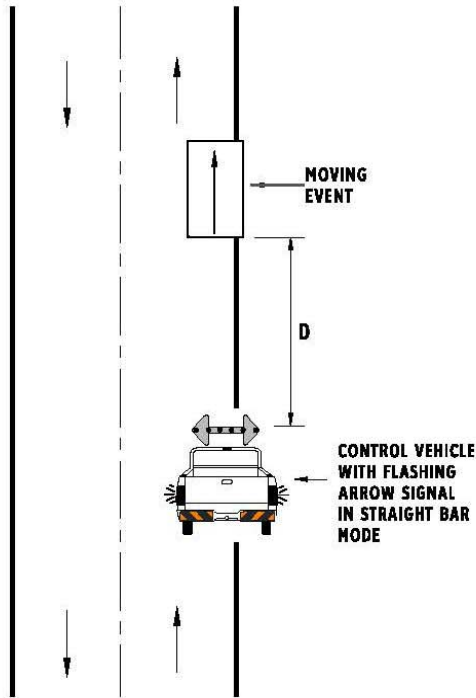

**FIGURE 2
DIVIDED HIGHWAY**

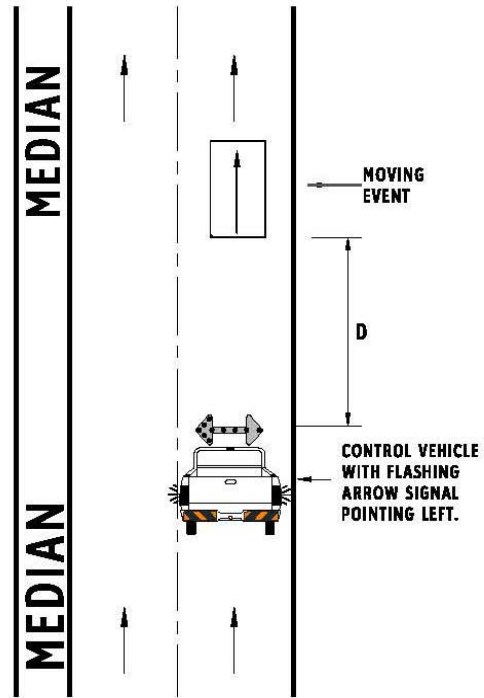

NOTE:

1. MOVING EVENTS SHALL INCLUDE SPORTING OR CHARITABLE ACTIVITIES WHERE INDIVIDUALS OR GROUPS TRAVEL BETWEEN POINTS ALONG PROVINCIAL HIGHWAYS. INDIVIDUALS OR GROUPS PLANNING SUCH ACTIVITIES MUST INFORM THE DEPARTMENT OF TRANSPORTATION AND WORKS PRIOR TO THE EVENT, AND PROVIDE (1) PROPOSED SIGNING/SAFETY/VEHICLE DETAILS, (2) AN INSURANCE POLICY PROTECTING THE PROVINCE FROM ALL LIABILITIES ASSOCIATED WITH THE EVENT, (3) A SCHEDULE SHOWING THE ENTIRE EVENT, (4) A COMMITMENT TO PROVIDE ALL NECESSARY SIGN REMOVAL AND CLEAN-UP IMMEDIATELY FOLLOWING THE EVENT. FINAL SIGNING DETAILS WILL BE DETERMINED BY THE DEPARTMENT OF TRANSPORTATION AND WORKS, AND WILL BE THE RESPONSIBILITY OF THE EVENT'S SPONSORS TO SUPPLY, INSTALL, MAINTAIN AND REMOVE.
2. MOVING EVENTS ALONG A TWO-WAY HIGHWAY SHALL, WHEREVER POSSIBLE, OCCUR ALONG THE PAVED SHOULDER OR GRAVEL SHOULDER OF THE HIGHWAY. IF CONDITIONS EXIST SUCH THAT SHOULDER SPACE CANNOT BE UTILIZED, THEN THE MOVING EVENT SHALL KEEP AS CLOSE TO THE RIGHT SIDE OF THE DRIVING LANE AS POSSIBLE. IN EACH CASE, THE MOVING EVENT SHALL INCLUDE AS A MINIMUM, THE USE OF A CONTROL VEHICLE EQUIPPED WITH A FLASHING ARROW SIGNAL IN THE 'STRAIGHT BAR FLASHING MODE'. THE CONTROL VEHICLE SHALL FOLLOW THE EVENT AT A DISTANCE 'D', AS SHOWN IN THE CONSTRUCTION DISTANCE TABLE ON PAGE 799-1.
3. MOVING EVENTS ALONG A DIVIDED HIGHWAY SHALL ONLY OCCUR IN THE RIGHT-HAND LANE AND SHALL INCLUDE AS A MINIMUM, THE USE OF A CONTROL VEHICLE, EQUIPPED WITH A FLASHING ARROW SIGNAL, DIRECTING TRAFFIC TO THE LEFT-HAND LANE. THE CONTROL VEHICLE SHALL FOLLOW THE EVENT AT A DISTANCE 'D', AS SHOWN IN THE CONSTRUCTION DISTANCE TABLE 799-1
4. A CRASH ATTENUATOR MAY BE ADDED TO THIS SETUP.

13.0 SIGN LAYOUT DIAGRAMS

13.1 TAFFIC CONTROL LAYOUT SELECTION

In order to properly select the most appropriate traffic control layout, the following four items must be considered:

1. Work Location – The intended activity’s location within the right-of-way is a major factor when selecting the appropriate traffic control layout. The more an activity encroaches into the roadway and interferes with the flow of traffic, the greater the level of traffic control required. There are four categories of work location:
 - a. Roadside Work - work carried out within 15 meters of the travelled lanes but outside the shoulder area (includes paved and gravel shoulders).
 - b. Shoulder Work - work carried out on the shoulder area of a road, but does not encroach on the travelled lanes of the roadway.
 - c. Partial Lane Closure - work carried out on a travelled lane resulting in a reduction of the useable lane width to a minimum of 3.0 meters.
 - d. Lane Closure - work carried out on the travelled lane resulting in a reduction of the useable lane width to less than 3.0 meters.
2. Work Duration - is the length of time that an activity will occupy a single location or several adjacent locations that are effectively considered as one location. There are four categories of work duration:
 - a. Mobile or Moving Operations - work that is either done continuously, usually at low speeds, or intermittently, with brief stops related to the work.
 - b. Very Short Term or Very Short Duration - work that occurs in a fixed location for a period not exceeding 30 minutes, including the time required to setup and remove traffic control devices.
 - c. Short Term or Short Duration - work that occurs in a fixed location for a period exceeding 30 minutes, but less than 12 consecutive hours.
 - d. Long Term or Long Duration - work that occurs in a fixed location for a period exceeding 12 consecutive hours.
3. Traffic Volumes - the traffic volumes for the roadway where the activity will occur may also affect the level of traffic control required. In general, low volume roadways may require less traffic control measures when compared to similar high volume locations. For the layouts presented in this manual a Low Volume roadway will be considered a roadway where the AADT is equal to or less than 500 vehicles per day.
4. Vehicle Speeds – As vehicle speeds increase, so too does the distance a motorists requires to recognize, interpret, and react to traffic control devices or personnel

they may encounter in the work area. To account for this change, each layout includes a Construction Distance Table to provide the minimum distances required based on the posted speed of the roadway.

13.2 DECISION MATRIX AND TYPICAL LAYOUTS

The following decision matrix tables may be used to help determine the most appropriate traffic control layout required to safely complete the work activity. The tables have been separated into the following categories:

- General Traffic Control Signage Information, found on page 88
- General Layouts - Two Lane Road, found on page 89
- General Layouts - Multi-Lane Road Undivided, found on page 90
- General Layouts - Multi-Lane Divided Highway, found on page 92
- Special Activity Layouts, found on page 94

In order to assess and determine the appropriate traffic control layout users will need to first determine the work location, work duration, traffic volume and speeds for the location.

General Traffic Control Signage Information

Activity		Work Location		Work Duration		Traffic/Speed		Figure
Typical Advanced Warning & Approach Signage on Construction Projects with Flagperson Lane Control	→	All	→	All	→	All	→	740-1
Typical Advanced Warning & Approach Signage on Construction Projects without Lane Control	→	All	→	All	→	All	→	740-2
Typical Advanced Warning & Approach Signage on Maintenance Projects with Flagperson Lane Control	→	All	→	All	→	All	→	740-3
Typical Advanced Warning & Approach Signage on Maintenance Projects without Lane Control	→	All	→	All	→	All	→	740-4
Intersecting Roads in Work Area	→	All	→	Long Term	→	> 60km/h	→	756-1
						≤ 60km/h	→	756-2
Positioning of Flagperson	→	All	→	All	→	All	→	757-1
Positioning of Flagperson on Hill	→	All	→	All	→	All	→	757-2
Pavement Drop Off	→	All	→	All	→	All	→	758-1
Truck Entrance	→	All	→	All	→	All	→	759-1
Truck Entrance W/ Flagperson	→	All	→	All	→	> 60km/h	→	759-1F
Portable Sign Supports	→	All	→	All	→	All	→	790-1
Timing of Portable Traffic Lights	→	All	→	All	→	All	→	791-1
Construction Distance Table	→	All	→	All	→	All	→	799-1
Legend	→	All	→	All	→	All	→	799-2

General Layouts – Two Lane Road

Activity		Work Location		Work Duration		Traffic/Speed		Figure
Work Adjacent to Roadway	→	Right Shoulder	→	Mobile Operations	→	All	→	750-2
			→	Very Short Term	→	All	→	750-2
			→	Short Term	→	All	→	750-1
			→	Long Term	→	All	→	750-1
Work at Edge of Roadway - Partial Lane Closure	→	Encroachment in Right Lane	→	Mobile Operations	→	All	→	751-3
			→	Very Short Term	→	All	→	751-2
			→	Short Term	→	All	→	751-2
			→	Long Term	→	All	→	751-1
One Lane Closed - Flagperson	→	Right Lane	→	All	→	> 60km/h	→	752-1
					→	≤ 60km/h	→	752-2
One Lane Closed - Slow Moving Operations	→	Right Lane	→	All	→	All	→	752-3
One Lane Closed - Portable Traffic Lights	→	Right Lane	→	Short Term	→	All	→	752-4
			→	Long Term	→	All	→	752-4
One Lane Closed - Yield to Oncoming Traffic	→	Right Lane	→	Very Short Term	→	Low Volume	→	752-5
			→	Short Term	→	Low Volume	→	752-5
			→	Long Term	→	Low Volume	→	752-5
One Lane Closed - Single Automated Flagging Device	→	Right Lane	→	All	→	≤ 60km/h	→	792-1
					→	> 60km/h	→	792-2
One Lane Closed - Dual Automated Flagging Device	→	Right Lane	→	All	→	≤ 60km/h	→	792-3
					→	> 60km/h	→	792-4
One Lane Closed - Successive Work Areas	→	Right Lane	→	All	→	All	→	753-1
One Lane Closed - Successive Work Areas, Slow Moving Operations	→	Right Lane	→	All	→	All	→	753-2
Roadside Diversion - Two Lanes Closed	→	Roadway	→	Short Term	→	All	→	754-1
			→	Long Term	→	All	→	754-1
Detour - Road Closure	→	Roadway	→	Short Term	→	All	→	755-1
			→	Long Term	→	All	→	755-2
Intersection - Lane Closed Near Side	→	Right Lane	→	All	→	All	→	756-3
Intersection - Lane Closed Far Side	→	Right Lane	→	All	→	All	→	756-4
Grading Operations	→	Right Lane	→	All	→	All	→	775-1
Road Closed	→	Roadway	→	All	→	All	→	776-1
Road Closed At T-Intersection	→	Roadway	→	All	→	All	→	776-2
Road Closed W/ Flagperson	→	Roadway	→	Very Short Term	→	All	→	776-3
			→	Short Term	→	All	→	776-3

General Layouts – Multi-Lane Road Undivided

Activity	Work Location	Work Duration	Traffic/Speed	Figure
Work Adjacent to Roadway	→ Right Shoulder	→ Mobile Operations →	All →	750-4
		→ Very Short Term →	All →	750-4
		→ Short Term →	All →	750-3
		→ Long Term →	All →	750-3
Work at Edge of Roadway - Partial Lane Closure	→ Encroachment in Right Lane	→ Mobile Operations →	All →	751-7
		→ Very Short Term →	All →	751-8
		→ Short Term →	All →	751-8
		→ Long Term →	All →	751-9
Lane Closure - Four Lane Road	→ Left Lane	→ Mobile Operations →	All →	752-8
		→ Very Short Term →	All →	752-11
		→ Short Term →	All →	752-7
		→ Long Term →	All →	752-7
	→ Right Lane	→ Mobile Operations →	All →	752-8
		→ Very Short Term →	All →	752-13
		→ Short Term →	All →	752-16
		→ Long Term →	All →	752-16
Lane Closure - Five Lane Road	→ Left Lane	→ Mobile Operations →	All →	752-8
		→ Very Short Term →	All →	752-18
		→ Short Term →	All →	752-18
		→ Long Term →	All →	752-18
	→ Center Lane - Two-Way Turn Lane	→ Mobile Operations →	All →	752-8
		→ Very Short Term →	All →	752-19
		→ Short Term →	All →	752-19
		→ Long Term →	All →	752-19
	→ Right Lane	→ Mobile Operations →	All →	752-8
		→ Very Short Term →	All →	752-13
		→ Short Term →	All →	752-16
		→ Long Term →	All →	752-16
Lane Closure w/ Crash Attenuators	→ Left Lane	→ Mobile Operations →	All →	752-34
		→ Very Short Term →	All →	752-35
	→ Right Lane	→ Mobile Operations →	All →	752-34
		→ Very Short Term →	All →	752-36
		→ Short Term →	All →	752-37
		→ Long Term →	All →	752-37
Two Lanes Closed - Four Lane Road	→ Right Lanes	→ Very Short Term →	All →	752-20
		→ Short Term →	All →	752-20
		→ Long Term →	All →	752-20

Continued on next page

General Layouts – Multi-Lane Road Undivided

Activity		Work Location		Work Duration		Traffic/Speed		Figure
Two Lanes Closed - Five Lane Road	→	Right Lanes	→	Very Short Term	→	All	→	752-21
			→	Short Term	→	All	→	752-21
			→	Long Term	→	All	→	752-21
Two Lanes Closed - Five Lane Road	→	Center Lane & Left Lane	→	Very Short Term	→	All	→	752-22
			→	Short Term	→	All	→	752-22
			→	Long Term	→	All	→	752-22
Exit Lane / Ramp Closure	→	Right Lane	→	Very Short Term	→	All	→	752-23
			→	Short Term	→	All	→	752-23
			→	Long Term	→	All	→	752-24
Partial Exit Lane / Ramp Closure	→	Right Lane	→	Very Short Term	→	All	→	752-25
			→	Short Term	→	All	→	752-25
			→	Long Term	→	All	→	752-25
Partial Entrance Lane / Ramp Closure	→	Right Lane	→	Very Short Term	→	All	→	752-26
			→	Short Term	→	All	→	752-26
			→	Long Term	→	All	→	752-26
Climbing Lane Closed	→	Right Lane	→	Short Term	→	≤ 60km/h	→	752-27
			→	Long Term	→	≤ 60km/h	→	752-27
Center Climbing Lane Closed	→	Center/Left Lane	→	Short Term	→	≤ 60km/h	→	752-28
			→	Long Term	→	≤ 60km/h	→	752-28
Lane Closure Opposite Climbing Lane	→	Left Lane	→	Short Term	→	≤ 60km/h	→	752-29
			→	Long Term	→	≤ 60km/h	→	752-29
Roadside Diversion - Two Lanes Closed	→	Roadway	→	Short Term	→	All	→	754-2 & 3
			→	Long Term	→	All	→	754-2 & 3
Lane Realignment	→	Roadway	→	Short Term	→	All	→	755-3
			→	Long Term	→	All	→	755-3

General Layouts – Multi-Lane Divided Highway

Activity	Work Location	Work Duration	Traffic/Speed	Figure
Work Adjacent to Roadway	→ Right Shoulder	→ Mobile Operations →	All →	750-5
		→ Very Short Term →	All →	750-5
		→ Short Term →	All →	750-3
		→ Long Term →	All →	750-3
	→ Left Shoulder	→ Mobile Operations →	All →	750-6
		→ Very Short Term →	All →	750-6
		→ Short Term →	All →	750-7
		→ Long Term →	All →	750-7
Work in Median	→ Median	→ Mobile Operations →	All →	750-8
		→ Very Short Term →	All →	750-9
		→ Short Term →	All →	750-9
		→ Long Term →	All →	750-9
Work at Edge of Roadway - Partial Lane Closure	→ Encroachment in Left Lane	→ Mobile Operations →	All →	751-4
		→ Very Short Term →	All →	751-5
		→ Short Term →	All →	751-5
		→ Long Term →	All →	751-6
	→ Encroachment in Right Lane	→ Mobile Operations →	All →	751-7
		→ Very Short Term →	All →	751-8
		→ Short Term →	All →	751-8
		→ Long Term →	All →	751-9
One Lane Closed - Flagperson	→ Right Lane	→ Very Short Term →	All →	752-6
		→ Short Term →	All →	752-6
Lane Closure	→ Left Lane	→ Mobile Operations →	All →	752-9
		→ Very Short Term →	< 70km/h →	752-10
		→ Short Term →	All →	752-12
		→ Long Term →	All →	752-17
	→ Right Lane	→ Mobile Operations →	All →	752-9
		→ Very Short Term →	All →	752-14
		→ Short Term →	All →	752-15
		→ Long Term →	All →	752-15
Lane Closure w/ Crash Attenuators	→ Left Lane	→ Very Short Term →	All →	752-30
		→ Short Term →	All →	752-32
		→ Long Term →	All →	752-32
	→ Right Lane	→ Very Short Term →	All →	752-31
		→ Short Term →	All →	752-33
		→ Long Term →	All →	752-33

Continued on next page

General Layouts – Multi-Lane Divided Highway

Activity		Work Location		Work Duration		Traffic/Speed		Figure
Lane Closure - Zipper Merge	→	Right Lane	→	All	→	All	→	793
Exit Lane / Ramp Closure	→	Right Lane	→	Very Short Term	→	All	→	752-23
			→	Short Term	→	All	→	752-23
			→	Long Term	→	All	→	752-24
Partial Exit Lane / Ramp Closure	→	Right Lane	→	Very Short Term	→	All	→	752-25
			→	Short Term	→	All	→	752-25
			→	Long Term	→	All	→	752-25
Partial Entrance Lane / Ramp Closure	→	Right Lane	→	Very Short Term	→	All	→	752-26
			→	Short Term	→	All	→	752-26
			→	Long Term	→	All	→	752-26
Road Closed W/ Flagperson	→	Roadway	→	Very Short Term	→	All	→	776-4
			→	Short Term	→	All	→	776-4

Special Activity Layouts

Activity - Line Painting		Work Location		Work Duration		Traffic/Speed		Figure
Line Painting Procedures	→	Roadway	→	All	→	All	→	771-1
Temporary Striping	→	Roadway	→	All	→	All	→	770-1
Painting Center Cross Hatching	→	Roadway	→	All	→	≥ 60km/h	→	771-2
					→	< 60km/h	→	771-7
Painting Center Cross Hatching W/ Flagperson	→	Roadway	→	All	→	≥ 60km/h	→	771-2F
					→	< 60km/h	→	771-7F
Painting Center Cross Hatching - Multiple Lanes	→	Roadway	→	All	→	All	→	771-12F
Painting in Through Lane	→	Left Side	→	All	→	≥ 60km/h	→	771-3
					→	< 60km/h	→	771-8
	→	Right Side	→	All	→	< 60km/h	→	771-8A
Painting in Through Lane W/ Flagperson	→	Left Side	→	All	→	≥ 60km/h	→	771-3F
					→	< 60km/h	→	771-8F
	→	Right Side	→	All	→	≥ 60km/h	→	771-3AF
					→	< 60km/h	→	771-8AF
Arrows, Stop Bars & Islands	→	Left Side	→	All	→	≥ 60km/h	→	771-4
					→	< 60km/h	→	771-9
	→	Right Side	→	All	→	≥ 60km/h	→	771-4A
					→	< 60km/h	→	771-9A
Arrows, Stop Bars & Islands W/ Flagperson	→	Left Side	→	All	→	≥ 60km/h	→	771-4F
					→	< 60km/h	→	771-9F
	→	Right Side	→	All	→	≥ 60km/h	→	771-4AF
					→	< 60km/h	→	771-9AF
Arrows, Stop Bars & Islands - Multiple Lanes	→	Left Side	→	All	→	All	→	771-13F
	→	Right Side	→	All	→	All	→	771-13AF
Arrows, Stop Bars, Islands & Crosswalks	→	Roadway	→	All	→	< 60km/h	→	771-17F
Ramp Painting	→	Roadway	→	All	→	All	→	771-5
Ramp Painting W/ Flagperson	→	Roadway	→	All	→	All	→	771-5F
Painting Words/Symbols	→	Left Lane	→	All	→	All	→	771-6
Trageting / Dotting - Two Way Traffic	→	Roadway	→	All	→	All	→	771-10
Trageting / Dotting - Divided Highway	→	Roadway	→	All	→	All	→	771-11
Intersecting Roadways	→	Roadway	→	All	→	All	→	771-14F
Lane Markings - Rapid Moving	→	Roadway	→	All	→	All	→	771-15
Activity - Surveying								
		Work Location		Work Duration		Traffic/Speed		Figure
Survey Crew - Two Way Traffic	→	Roadway	→	All	→	All	→	780-1
Survey Crew - Divided Highway	→	Roadway	→	All	→	All	→	780-2
Survey Crew - Adjacent To Roadway	→	Shoulder Work	→	All	→	All	→	780-3

TRAFFIC CONTROL MANUAL

2018

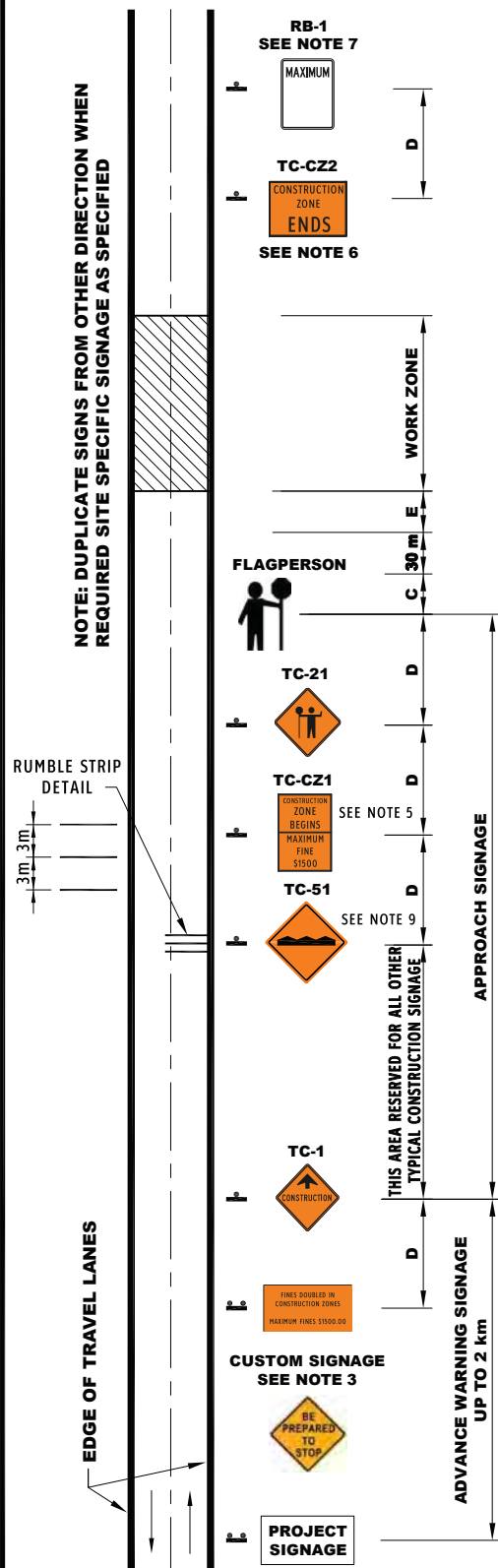

WORK ZONE DIMENSIONS FOR ADVANCE WARNING AND APPROACH SIGNAGE ON CONSTRUCTION PROJECTS

DIMENSION (m)	NORMAL POSTED REGULATORY SPEED					
	50	60	70	80	90	100
A	30	40	60	90	110	180
B	5/8	8/12	10/15	10/15	12/18	15/20
C	30	40	40	50	50	50
D	50	50	75	100	100	150
E	35	50	50	75	75	75

POSTED SPEED IS EXISTING SPEED LIMIT (km/h)

A - TAPER LANE WHEN NO LANE CONTROL PRESENT

B - MAX. DELINEATOR SPACING IN TAPER/WORK ZONE

C - TRAFFIC CONTROL PERSON SETBACK (m)

D - DISTANCE BETWEEN CONSTRUCTION SIGNS

E - BUFFER AREA LENGTH BETWEEN TAPER AND WORK ZONE

NOTES

- ALL CONSTRUCTION OPERATIONS MUST BE SIGNED IN ACCORDANCE WITH TYPICAL SIGN LAYOUTS AS SHOWN IN THE DEPARTMENT'S TRAFFIC CONTROL MANUAL.
- ANY SPACING NOTED ON THE ABOVE DIAGRAM, SUCH AS 'D' OR 'C', REFER TO THE CONSTRUCTION DISTANCE TABLE AS SHOWN ABOVE AND ON 799-1. WHEN LANE CONTROL IS PRESENT, TAPER DISTANCE A = 30 m. SEE SIGN LAYOUTS FOR SPECIFIC SITUATIONS.
- A LARGER CUSTOMIZED SIGN MAY BE REQUIRED ON MAJOR TRUNK ROADS, OR ALTERNATIVELY A VMS WITH A CUSTOM MESSAGE.
- THE SIGN 'FINES DOUBLED IN CONSTRUCTION ZONES - MAXIMUM FINE \$1500' TO BE INSTALLED ON CONSTRUCTION PROJECTS WITH HIGH SPEED AND HIGH TRAFFIC VOLUME, JUST IN ADVANCE OF THE TC-1, CONSTRUCTION AHEAD SIGN.
- THE SIGN 'CONSTRUCTION ZONE BEGINS - MAXIMUM FINE \$1500' MUST BE INSTALLED AS THE LAST SIGN IN THE SEQUENCE OF TYPICAL CONSTRUCTION SIGNS, EXCEPT WHERE FLAGPERSONS OR PORTABLE TRAFFIC LIGHTS ARE REQUIRED. IN THESE CASES, THIS 'CONSTRUCTION ZONE BEGINS - MAXIMUM FINE \$1500' SIGN MUST BE INSTALLED JUST PRIOR TO THE TC-21 FLAGPERSON SIGN OR THE TC-181 TRAFFIC LIGHT SIGN.
- THE SIGN 'CONSTRUCTION ZONE ENDS' MUST BE INSTALLED FOLLOWING THE END OF EACH CONSTRUCTION ZONE, DIRECTLY ACROSS FROM THE TC-CZ1 THAT IS INSTALLED IN THE OPPOSITE DIRECTION.
- AN RB-1 MAXIMUM SPEED LIMIT SIGN IS REQUIRED TO RETURN REGULAR OPERATING SPEED LIMIT, IF THE SPEED LIMIT HAS BEEN REDUCED THROUGH THE CONSTRUCTION ZONE.
- THE FINAL PLACEMENT OF ALL CONSTRUCTION SIGNS AND ANY ADDITIONAL SIGNS, INCLUDING SIGNS ON INTERSECTING ROADS WITHIN THE CONSTRUCTION ZONE, WILL BE DETERMINED BY THE USER'S REPRESENTATIVE AND BASED ON SOUND TECHNICAL JUDGMENT. SEE 756-1 TO 756-4 FOR DETAILS ON SIGNAGE FOR INTERSECTING ROADS.
- WHERE TEMPORARY RUMBLE STRIPS ARE CHOSEN TO BE USED AS PART OF THE TRAFFIC CONTROL DEVICES, THEY SHALL BE INSTALLED BEFORE SIGN TC-CZ1 AND BE ACCOMPANIED BY THE TC-51 SIGN. THE TEMPORARY RUMBLE STRIPS SHALL BE INSTALLED AS ONE SECTION CONTAINING THREE STRIPS. FOR FURTHER INFORMATION PLEASE REFER TO SECTION 6.24 TEMPORARY RUMBLE STRIPS.

740-1



TRANSPORTATION AND WORKS
HIGHWAY DESIGN DIVISION

TYPICAL ADVANCE WARNING AND APPROACH WORK ZONE SIGNAGE ON CONSTRUCTION PROJECTS WITH FLAGPERSON LANE CONTROL

DRAWN BY: KR

DATE: Rev July 2018

NOT TO SCALE

TRAFFIC CONTROL MANUAL 2018

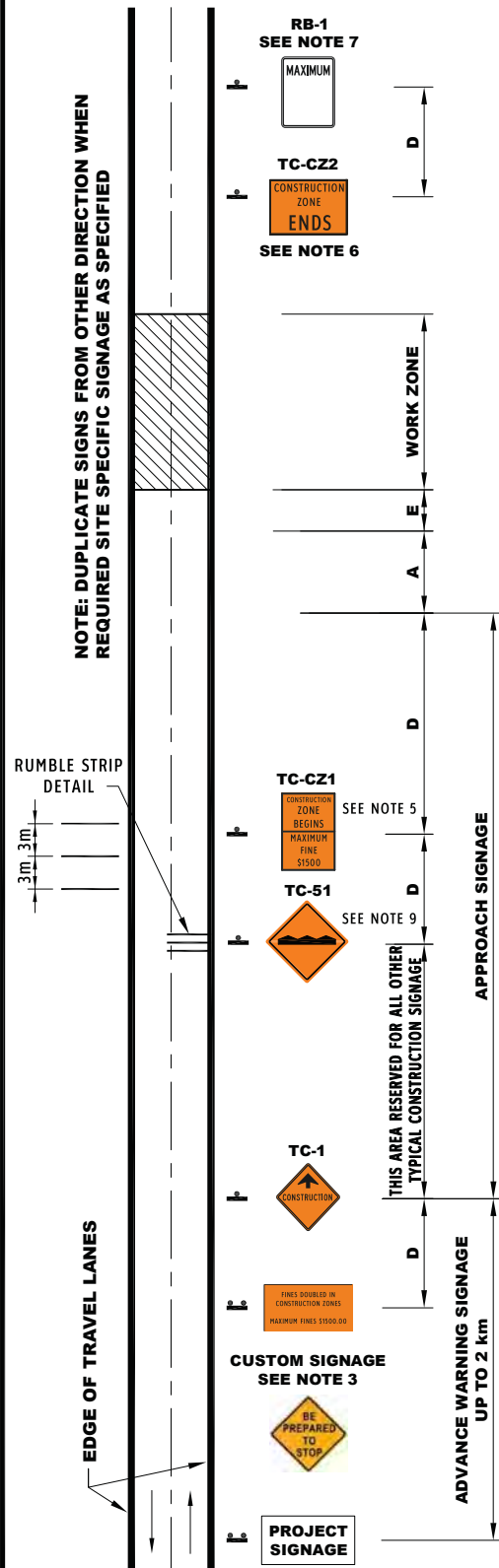

WORK ZONE DIMENSIONS FOR ADVANCE WARNING AND APPROACH SIGNAGE ON CONSTRUCTION PROJECTS

DIMENSION (m)	NORMAL POSTED REGULATORY SPEED					
	50	60	70	80	90	100
A	30	40	60	90	110	180
B	5/8	8/12	10/15	10/15	12/18	15/20
C	30	40	40	50	50	50
D	50	50	75	100	100	150
E	35	50	50	75	75	75

POSTED SPEED IS EXISTING SPEED LIMIT (km/h)

A - TAPER LANE WHEN NO LANE CONTROL PRESENT

B - MAX. DELINEATOR SPACING IN TAPER/WORK ZONE

C - TRAFFIC CONTROL PERSON SETBACK (m)

D - DISTANCE BETWEEN CONSTRUCTION SIGNS

E - BUFFER AREA LENGTH BETWEEN TAPER AND WORK ZONE

NOTES

- ALL CONSTRUCTION OPERATIONS MUST BE SIGNED IN ACCORDANCE WITH TYPICAL SIGN LAYOUTS AS SHOWN IN THE DEPARTMENT'S TRAFFIC CONTROL MANUAL.
- ANY SPACING NOTED ON THE ABOVE DIAGRAM, SUCH AS 'D' OR 'C', REFER TO THE CONSTRUCTION DISTANCE TABLE AS SHOWN ABOVE AND ON 799-1. WHEN LANE CONTROL IS PRESENT BY MEANS OF SIGNAGE, FLAGPERSON, OR TRAFFIC LIGHTS, TAPER DISTANCE A = 30 m. SEE SIGN LAYOUTS FOR SPECIFIC SITUATIONS.
- A LARGER CUSTOMIZED SIGN MAY BE REQUIRED ON MAJOR TRUNK ROADS, OR ALTERNATIVELY A VMS WITH A CUSTOM MESSAGE.
- THE SIGN 'FINES DOUBLED IN CONSTRUCTION ZONES - MAXIMUM FINE \$1500' TO BE INSTALLED ON CONSTRUCTION PROJECTS WITH HIGH SPEED AND HIGH TRAFFIC VOLUME, JUST IN ADVANCE OF THE TC-1, CONSTRUCTION AHEAD SIGN.
- THE SIGN 'CONSTRUCTION ZONE BEGINS - MAXIMUM FINE \$1500' MUST BE INSTALLED AS THE LAST SIGN IN THE SEQUENCE OF TYPICAL CONSTRUCTION SIGNS, EXCEPT WHERE FLAGPERSONS OR PORTABLE TRAFFIC LIGHTS ARE REQUIRED. IN THESE CASES, THIS 'CONSTRUCTION ZONE BEGINS - MAXIMUM FINE \$1500' SIGN MUST BE INSTALLED JUST PRIOR TO THE TC-21 FLAGPERSON SIGN OR THE TC-181 TRAFFIC LIGHT SIGN.
- THE SIGN 'CONSTRUCTION ZONE ENDS' MUST BE INSTALLED FOLLOWING THE END OF EACH CONSTRUCTION ZONE, DIRECTLY ACROSS FROM THE TC-CZ1 THAT IS INSTALLED IN THE OPPOSITE DIRECTION.
- AN RB-1 MAXIMUM SPEED LIMIT SIGN IS REQUIRED TO RETURN REGULAR OPERATING SPEED LIMIT, IF THE SPEED LIMIT HAS BEEN REDUCED THROUGH THE CONSTRUCTION ZONE.
- THE FINAL PLACEMENT OF ALL CONSTRUCTION SIGNS AND ANY ADDITIONAL SIGNS, INCLUDING SIGNS ON INTERSECTING ROADS WITHIN THE CONSTRUCTION ZONE, WILL BE DETERMINED BY THE USER'S REPRESENTATIVE AND BASED ON SOUND TECHNICAL JUDGMENT. SEE 756-1 TO 756-4 FOR DETAILS ON SIGNAGE FOR INTERSECTING ROADS.
- WHERE TEMPORARY RUMBLE STRIPS ARE CHOSEN TO BE USED AS PART OF THE TRAFFIC CONTROL DEVICES, THEY SHALL BE INSTALLED BEFORE SIGN TC-CZ1 AND BE ACCOMPANIED BY THE TC-51 SIGN. THE TEMPORARY RUMBLE STRIPS SHALL BE INSTALLED AS ONE SECTION CONTAINING THREE STRIPS. FOR FURTHER INFORMATION PLEASE REFER TO SECTION 6.24 TEMPORARY RUMBLE STRIPS.

740-2



TRANSPORTATION AND WORKS
HIGHWAY DESIGN DIVISION

TYPICAL ADVANCE WARNING AND APPROACH WORK ZONE SIGNAGE ON CONSTRUCTION PROJECTS WITHOUT LANE CONTROL

DRAWN BY: KR

DATE: Rev July 2018

NOT TO SCALE

TRAFFIC CONTROL MANUAL 2018

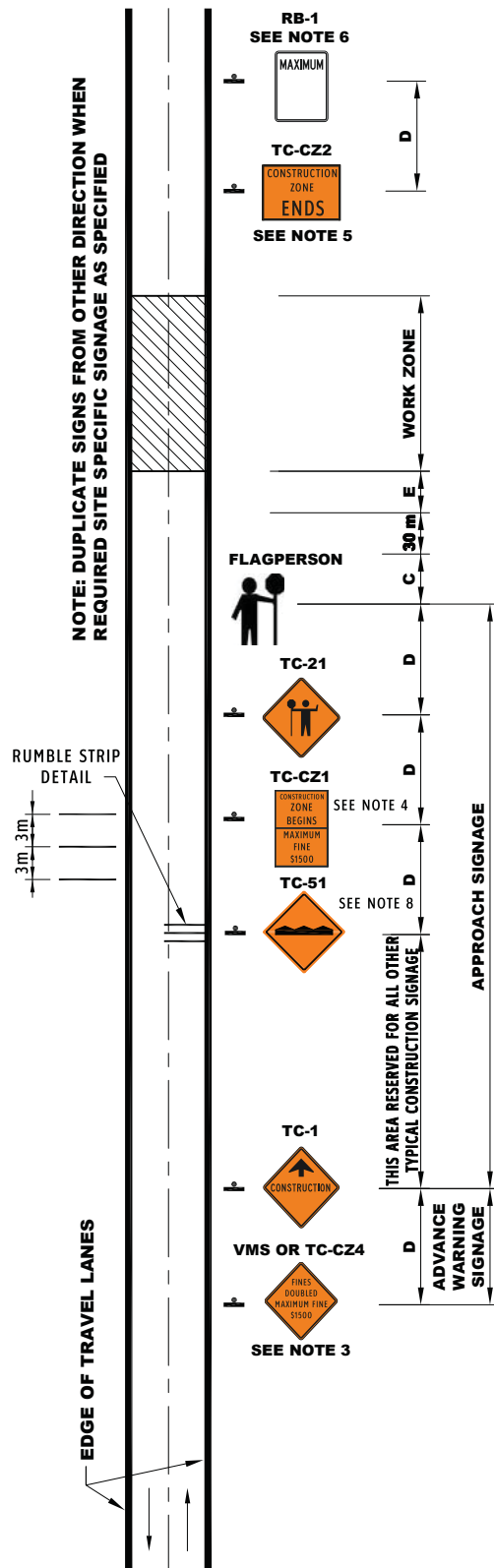

WORK ZONE DIMENSIONS FOR ADVANCE WARNING AND APPROACH SIGNAGE ON MAINTENANCE PROJECTS

DIMENSION (m)	NORMAL POSTED REGULATORY SPEED					
	50	60	70	80	90	100
A	30	40	60	90	110	180
B	5/8	8/12	10/15	10/15	12/18	15/20
C	30	40	40	50	50	50
D	50	50	75	100	100	150
E	35	50	50	75	75	75

POSTED SPEED IS EXISTING SPEED LIMIT (km/h)

A - TAPER LANE WHEN NO LANE CONTROL PRESENT

B - MAX. DELINEATOR SPACING IN TAPER/WORK ZONE

C - TRAFFIC CONTROL PERSON SETBACK (m)

D - DISTANCE BETWEEN CONSTRUCTION SIGNS

E - BUFFER AREA LENGTH BETWEEN TAPER AND WORK ZONE

NOTES

- ALL CONSTRUCTION AND MAINTENANCE OPERATIONS MUST BE SIGNED IN ACCORDANCE WITH TYPICAL SIGN LAYOUTS AS SHOWN IN THE DEPARTMENT'S TRAFFIC CONTROL MANUAL.
- ANY SPACING NOTED ON THE ABOVE DIAGRAM, SUCH AS 'D' OR 'C', REFER TO THE CONSTRUCTION DISTANCE TABLES AS SHOWN. WHEN LANE CONTROL IS PRESENT, TAPER DISTANCE A = 30m. SEE SIGN LAYOUTS FOR SPECIFIC SITUATIONS.
- A VMS OR THE SIGN 'FINES DOUBLED IN CONSTRUCTION ZONES - MAXIMUM FINE \$1500' MAY BE INSTALLED ON PROJECTS WITH HIGH SPEED AND HIGH TRAFFIC VOLUME, JUST IN ADVANCE OF THE TC-1, CONSTRUCTION AHEAD SIGN.
- THE SIGN 'CONSTRUCTION ZONE BEGINS - MAXIMUM FINE \$1500' MUST BE INSTALLED AS THE LAST SIGN IN THE SEQUENCE OF TYPICAL CONSTRUCTION SIGNS, EXCEPT WHERE FLAGPERSONS OR PORTABLE TRAFFIC LIGHTS ARE REQUIRED. IN THESE CASES, THIS 'CONSTRUCTION ZONE BEGINS - MAXIMUM FINE \$1500' SIGN MUST BE INSTALLED JUST PRIOR TO THE TC-21 FLAGPERSON SIGN OR THE TC-181 TRAFFIC LIGHT SIGN.
- THE SIGN 'CONSTRUCTION ZONE ENDS' MUST BE INSTALLED FOLLOWING THE END OF EACH CONSTRUCTION ZONE, DIRECTLY ACCROSS FROM THE TC-CZ1 THAT IS INSTALLED IN THE OPPOSITE DIRECTION.
- AN RB-1 MAXIMUM SPEED LIMIT SIGN IS REQUIRED TO RETURN REGULAR OPERATING SPEED LIMIT, IF THE SPEED LIMIT HAS BEEN REDUCED THROUGH THE CONSTRUCTION ZONE.
- THE FINAL PLACEMENT OF ALL CONSTRUCTION SIGNS AND ANY ADDITIONAL SIGNS, INCLUDING SIGNS ON INTERSECTING ROADS WITHIN THE CONSTRUCTION ZONE, WILL BE DETERMINED BY THE USER'S REPRESENTATIVE AND BASED ON SOUND TECHNICAL JUDGMENT. SEE 756-1 TO 756-4 FOR DETAILS ON SIGNAGE FOR INTERSECTING ROADS.
- WHERE TEMPORARY RUMBLE STRIPS ARE CHOSEN TO BE USED AS PART OF THE TRAFFIC CONTROL DEVICES, THEY SHALL BE INSTALLED BEFORE SIGN TC-CZ1 AND BE ACCOMPANIED BY THE TC-51 SIGN. THE TEMPORARY RUMBLE STRIPS SHALL BE INSTALLED AS ONE SECTION CONTAINING THREE STRIPS. FOR FURTHER INFORMATION PLEASE REFER TO SECTION 6.24 TEMPORARY RUMBLE STRIPS.

740-3



TRANSPORTATION AND WORKS
HIGHWAY DESIGN DIVISION

TYPICAL ADVANCE WARNING AND APPROACH WORK ZONE SIGNAGE ON MAINTENANCE PROJECTS WITH FLAGPERSON LANE CONTROL

DRAWN BY: KR

DATE: Rev July 2018

NOT TO SCALE

TRAFFIC CONTROL MANUAL

2018

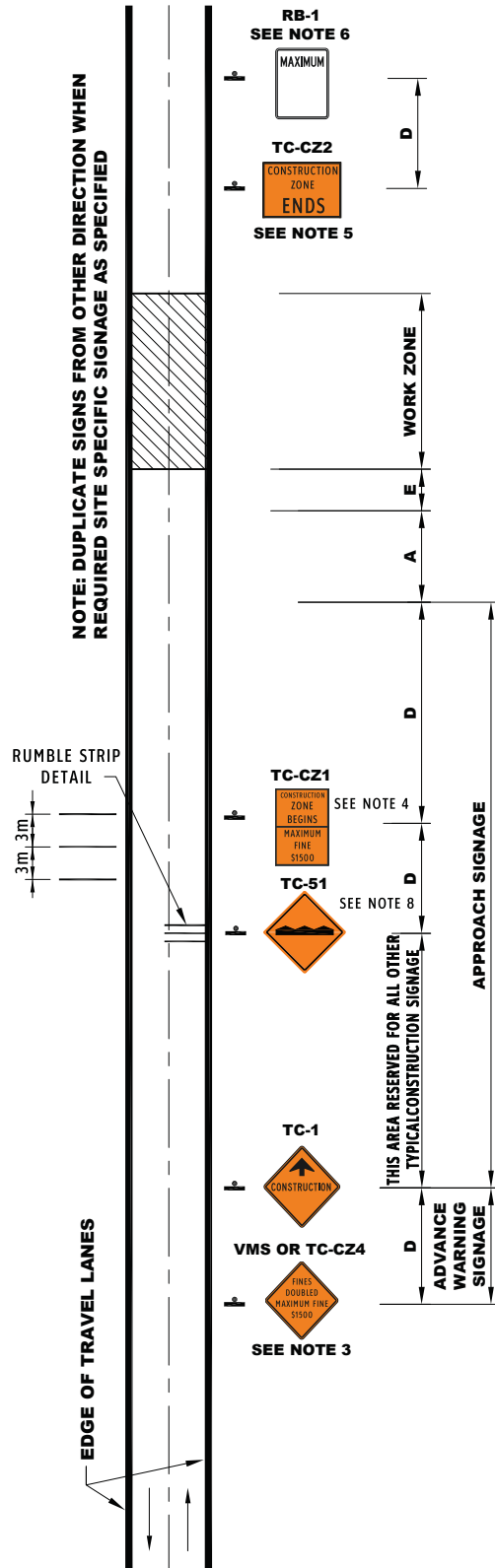

WORK ZONE DIMENSIONS FOR ADVANCE WARNING AND APPROACH SIGNAGE ON MAINTENANCE PROJECTS

DIMENSION (m)	NORMAL POSTED REGULATORY SPEED					
	50	60	70	80	90	100
A	30	40	60	90	110	180
B	5/8	8/12	10/15	10/15	12/18	15/20
C	30	40	40	50	50	50
D	50	50	75	100	100	150
E	35	50	50	75	75	75

POSTED SPEED IS EXISTING SPEED LIMIT (km/h)

A - TAPER LANE WHEN NO LANE CONTROL PRESENT

B - MAX. DELINEATOR SPACING IN TAPER/WORK ZONE

C - TRAFFIC CONTROL PERSON SETBACK (m)

D - DISTANCE BETWEEN CONSTRUCTION SIGNS

E - BUFFER AREA LENGTH BETWEEN TAPER AND WORK ZONE

NOTES

- ALL CONSTRUCTION AND MAINTENANCE OPERATIONS MUST BE SIGNED IN ACCORDANCE WITH TYPICAL SIGN LAYOUTS AS SHOWN IN THE DEPARTMENT'S TRAFFIC CONTROL MANUAL.
- ANY SPACINGS NOTED ON THE ABOVE DIAGRAM, SUCH AS 'D' OR 'C', REFER TO THE CONSTRUCTION DISTANCE TABLES AS SHOWN. WHEN LANE CONTROL IS PRESENT BY MEANS OF SIGNAGE, FLAGPERSON, OR TRAFFIC LIGHTS, TAPER DISTANCE A = 30m. SEE SIGN LAYOUTS FOR SPECIFIC SITUATIONS.
- A VMS OR THE SIGN 'FINES DOUBLED IN CONSTRUCTION ZONES - MAXIMUM FINE \$1500' MAY BE INSTALLED ON PROJECTS WITH HIGH SPEED AND HIGH TRAFFIC VOLUME, JUST IN ADVANCE OF THE TC-1, CONSTRUCTION AHEAD SIGN.
- THE SIGN 'CONSTRUCTION ZONE BEGINS - MAXIMUM FINE \$1500' MUST BE INSTALLED AS THE LAST SIGN IN THE SEQUENCE OF TYPICAL CONSTRUCTION SIGNS, EXCEPT WHERE FLAGPERSONS OR PORTABLE TRAFFIC LIGHTS ARE REQUIRED. IN THESE CASES, THIS 'CONSTRUCTION ZONE BEGINS - MAXIMUM FINE \$1500' SIGN MUST BE INSTALLED JUST PRIOR TO THE TC-21 FLAGPERSON SIGN OR THE TC-181 TRAFFIC LIGHT SIGN.
- THE SIGN 'CONSTRUCTION ZONE ENDS' MUST BE INSTALLED FOLLOWING THE END OF EACH CONSTRUCTION ZONE, DIRECTLY ACROSS FROM THE TC-CZ1 THAT IS INSTALLED IN THE OPPOSITE DIRECTION.
- AN RB-1 MAXIMUM SPEED LIMIT SIGN IS REQUIRED TO RETURN REGULAR OPERATING SPEED LIMIT, IF THE SPEED LIMIT HAS BEEN REDUCED THROUGH THE CONSTRUCTION ZONE.
- THE FINAL PLACEMENT OF ALL CONSTRUCTION SIGNS AND ANY ADDITIONAL SIGNS, INCLUDING SIGNS ON INTERSECTING ROADS WITHIN THE CONSTRUCTION ZONE, WILL BE DETERMINED BY THE USER'S REPRESENTATIVE AND BASED ON SOUND TECHNICAL JUDGMENT. SEE 756-1 TO 756-4 FOR DETAILS ON SIGNAGE FOR INTERSECTING ROADS.
- WHERE TEMPORARY RUMBLE STRIPS ARE CHOSEN TO BE USED AS PART OF THE TRAFFIC CONTROL DEVICES, THEY SHALL BE INSTALLED BEFORE SIGN TC-CZ1 AND BE ACCOMPANIED BY THE TC-51 SIGN. THE TEMPORARY RUMBLE STRIPS SHALL BE INSTALLED AS ONE SECTION CONTAINING THREE STRIPS. FOR FURTHER INFORMATION PLEASE REFER TO SECTION 6.24 TEMPORARY RUMBLE STRIPS.

740-4



TRANSPORTATION AND WORKS
HIGHWAY DESIGN DIVISION

TYPICAL ADVANCE WARNING AND APPROACH WORK ZONE SIGNAGE ON MAINTENANCE PROJECTS WITHOUT LANE CONTROL

DRAWN BY: KR

DATE: Rev July 2018

NOT TO SCALE

TRAFFIC CONTROL MANUAL

2018

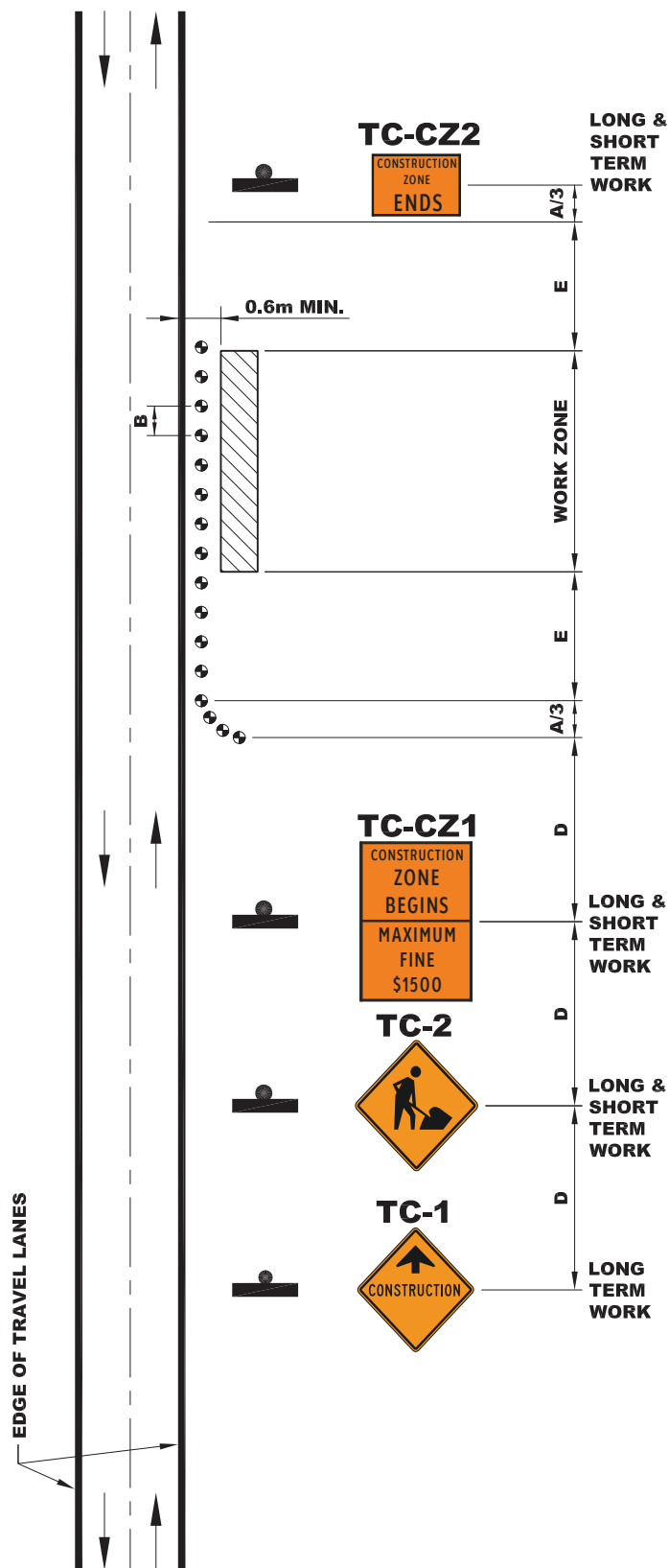

WORK ZONE DIMENSIONS FOR WORK ADJACENT TO TWO LANE ROADWAY SHORT OR LONG DURATION

DIMENSION (m)	NORMAL POSTED REGULATORY SPEED					
	50	60	70	80	90	100
A	30	40	60	90	110	180
B	5/8	8/12	10/15	10/15	12/18	15/20
C	30	40	40	50	50	50
D	50	50	75	100	100	150
E	35	50	50	75	75	75

POSTED SPEED IS EXISTING SPEED LIMIT (km/h)

A - TAPER LANE WHEN NO LANE CONTROL PRESENT

B - MAX. DELINEATOR SPACING IN TAPER/WORK ZONE

C - TRAFFIC CONTROL PERSON SETBACK (m)

D - DISTANCE BETWEEN CONSTRUCTION SIGNS

E - BUFFER AREA LENGTH BETWEEN TAPER AND WORK ZONE

NOTES

- SIGN OPPOSITE APPROACH IN THE SAME MANNER.
- WHERE A FLAGPERSON IS PRESENT FOR THIS OPERATION SIGN AS PER FORM 752-1 OR 752-2 AS APPROPRIATE.

750-1



TRANSPORTATION AND WORKS
HIGHWAY DESIGN DIVISION

WORK ADJACENT TO ROADWAY TWO-LANE ROAD -SHORT OR LONG TERM

DRAWN BY: R. LANGMEAD

DATE: Rev November 2018

NOT TO SCALE

TRAFFIC CONTROL MANUAL

2018

NOTES

1. WHERE THE DURATION OF THIS ACTIVITY IS DEFINED AS "VERY SHORT TERM WORK" REQUIRING A PERSON TO EXIT THE VEHICLE TWO WEIGHTED TRAFFIC CONES SHALL BE PLACED NEXT TO THE FRONT AND REAR TIRE.
2. ALL FLASHERS AND 360° ROTATING TOP MOUNTED BEACON SHALL BE ENGAGED.
3. FLASHING ARROW BOARD SHOULD BE ENGAGED IN NEUTRAL LIGHT POSITION IF AVAILABLE.
4. IF WORK IS CLASSIFIED AS SHORT OR LONG DURATION USE LAYOUT 750-1.

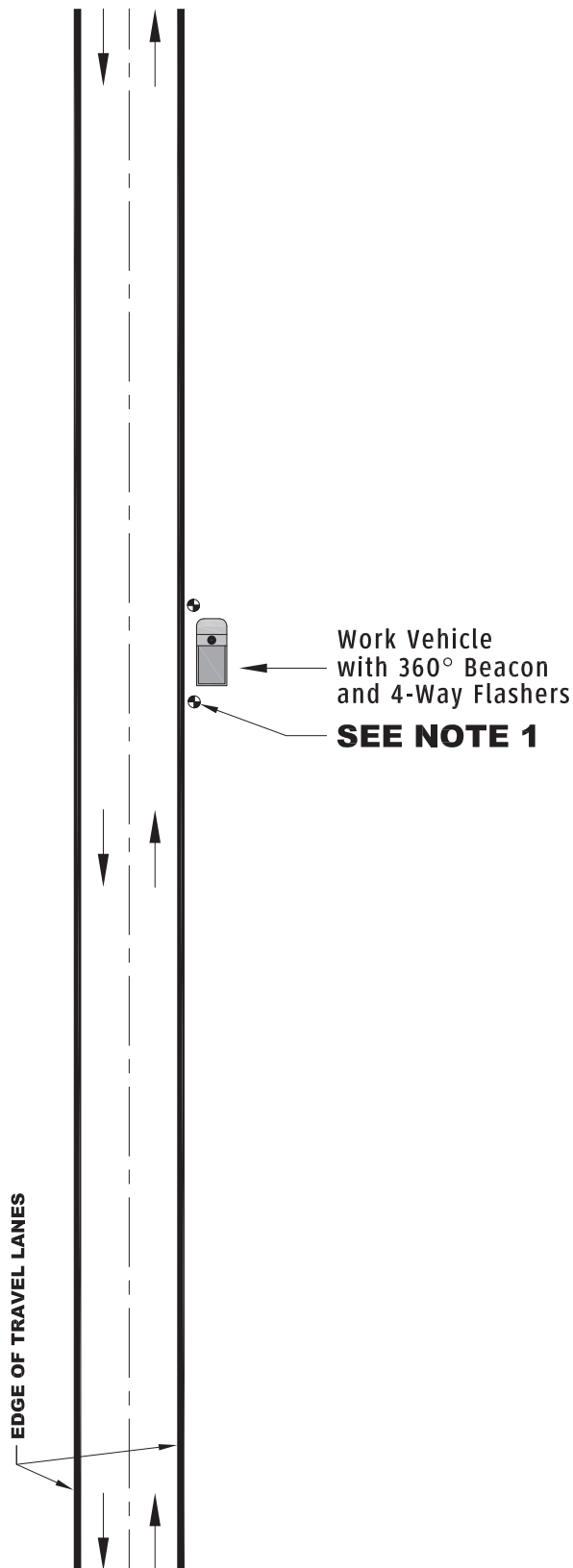

750-2



TRANSPORTATION AND WORKS
HIGHWAY DESIGN DIVISION

**WORK ADJACENT TO ROADWAY
TWO-LANE ROAD
VERY SHORT TERM OR MOBILE OPERATIONS**

DRAWN BY: JM

DATE: Rev November 2018

NOT TO SCALE

TRAFFIC CONTROL MANUAL

2018

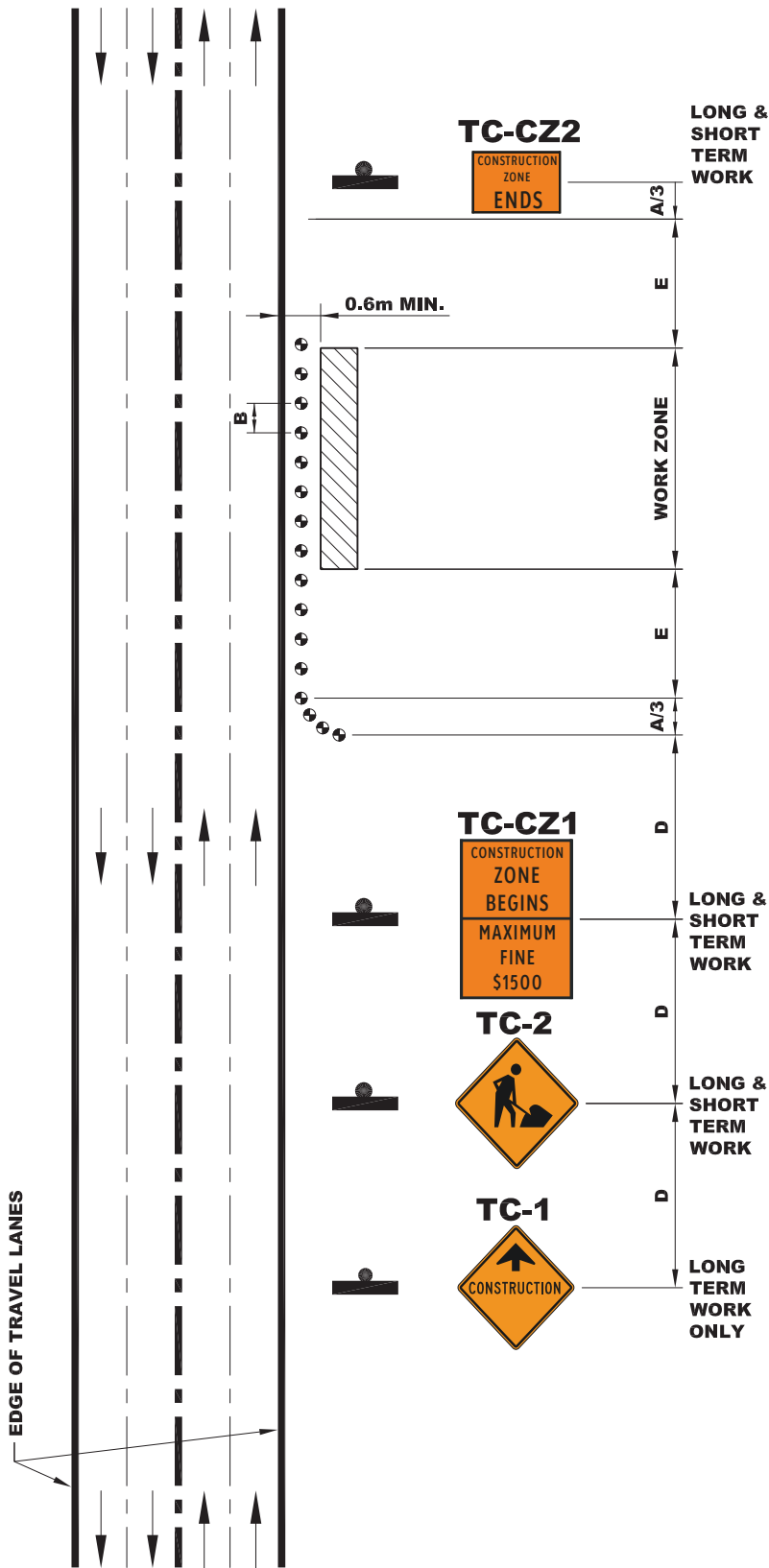

WORK ZONE DIMENSIONS FOR WORK ADJACENT TO ROADWAY SHORT OR LONG DURATIONS DIVIDED OR UNDIVIDED HIGHWAY

DIMENSION (m)	NORMAL POSTED REGULATORY SPEED					
	50	60	70	80	90	100
A	30	40	60	90	110	180
B	5/8	8/12	10/15	10/15	12/18	15/20
C	30	40	40	50	50	50
D	50	50	75	100	100	150
E	35	50	50	75	75	75

POSTED SPEED IS EXISTING SPEED LIMIT (km/h)

A - TAPER LANE WHEN NO LANE CONTROL PRESENT

B - MAX. DELINEATOR SPACING IN TAPER/WORK ZONE

C - TRAFFIC CONTROL PERSON SETBACK (m)

D - DISTANCE BETWEEN CONSTRUCTION SIGNS

E - BUFFER AREA LENGTH BETWEEN TAPER AND WORK ZONE

NOTES

1. SIGN OPPOSITE APPROACH IN THE SAME MANNER FOR UNDIVIDED HIGHWAY.
2. WHERE A FLAGPERSON IS PRESENT FOR THIS OPERATION SIGN AS PER FORM 752-1 OR 752-2 AS APPROPRIATE.

750-3



TRANSPORTATION AND WORKS
HIGHWAY DESIGN DIVISION

WORK ADJACENT TO ROADWAY MULTI-LANE ROAD - SHORT OR LONG TERM DIVIDED OR UNDIVIDED HIGHWAY

DRAWN BY: R. LANGMEAD

DATE: Rev November 2018

NOT TO SCALE

TRAFFIC CONTROL MANUAL

2018

NOTES

1. WHERE THE DURATION OF THIS ACTIVITY IS DEFINED AS "VERY SHORT TERM WORK" REQUIRING A PERSON TO EXIT THE VEHICLE TWO WEIGHTED TRAFFIC CONES SHALL BE PLACED NEXT TO THE FRONT AND REAR TIRE.
2. ALL FLASHERS AND 360° ROTATING TOP MOUNTED BEACON SHALL BE ENGAGED.
3. FLASHING ARROW BOARD SHOULD BE ENGAGED IN NEUTRAL LIGHT POSITION IF AVAILABLE.
4. IF WORK IS CLASSIFIED AS SHORT OR LONG DURATION USE LAYOUT 750-1 or 750-3.

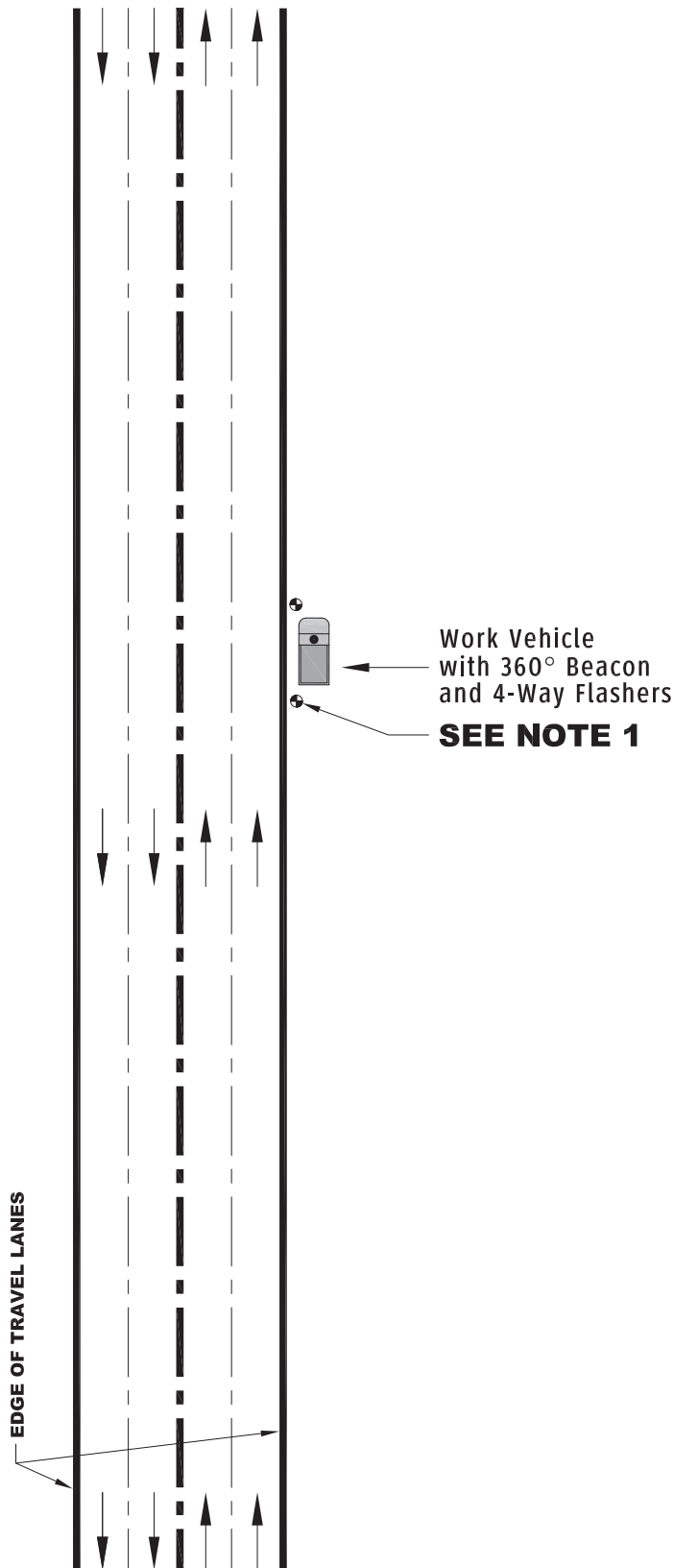

750-4

TRAFFIC CONTROL MANUAL

2018

NOTES

1. WHERE THE DURATION OF THIS ACTIVITY IS DEFINED AS "VERY SHORT TERM WORK" REQUIRING A PERSON TO EXIT THE VEHICLE TWO WEIGHTED TRAFFIC CONES SHALL BE PLACED NEXT TO THE FRONT AND REAR TIRE.
2. ALL FLASHERS AND 360° ROTATING TOP MOUNTED BEACON SHALL BE ENGAGED.
3. FLASHING ARROW BOARD SHOULD BE ENGAGED IN NEUTRAL LIGHT POSITION IF AVAILABLE.
4. IF WORK IS CLASSIFIED AS SHORT OR LONG DURATION USE LAYOUT 750-3.

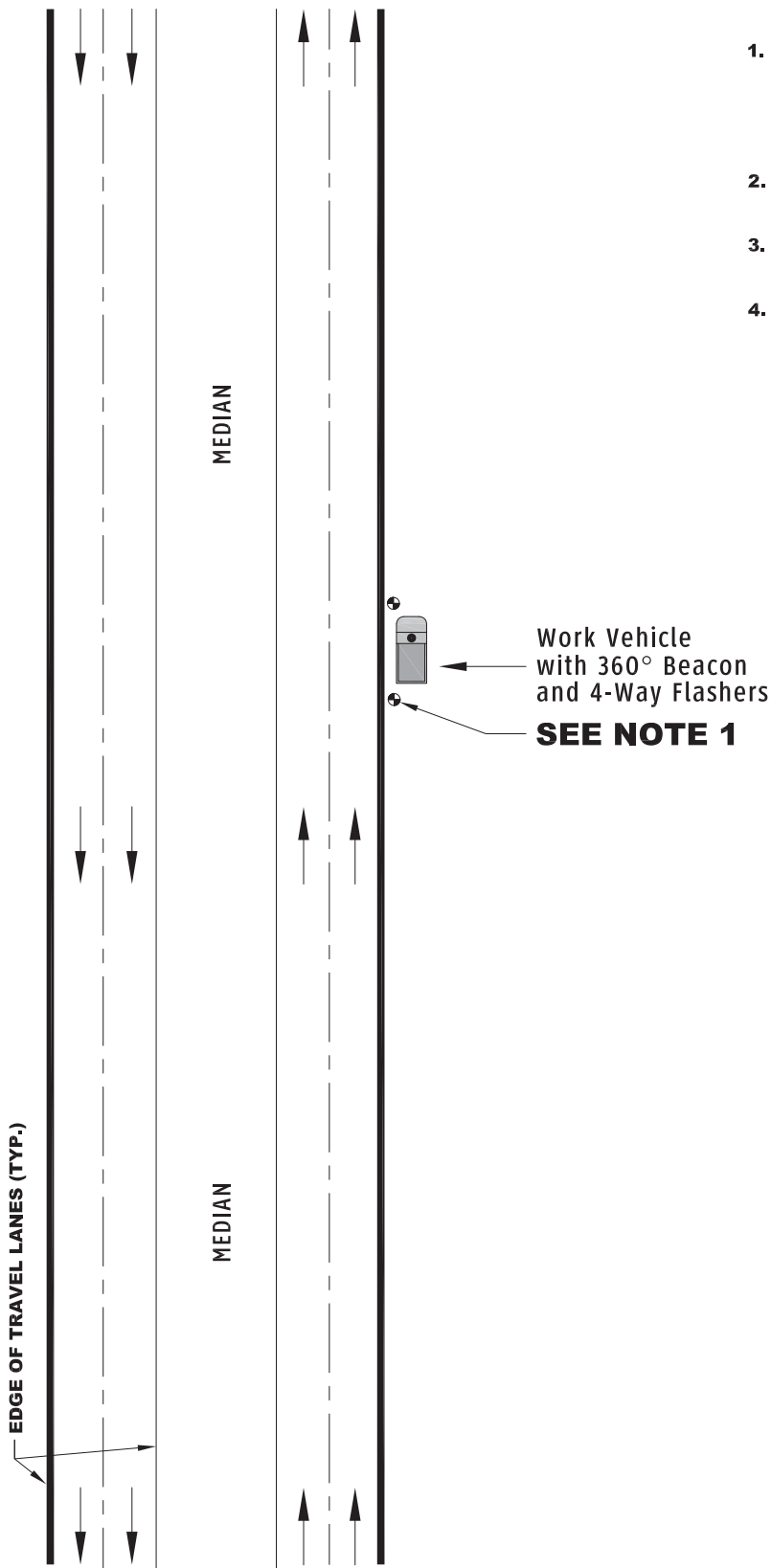

750-5

TRAFFIC CONTROL MANUAL

2018

NOTES

1. WHERE THE DURATION OF THIS ACTIVITY IS DEFINED AS "VERY SHORT TERM WORK" REQUIRING A PERSON TO EXIT THE VEHICLE TWO WEIGHTED TRAFFIC CONES SHALL BE PLACED NEXT TO THE FRONT AND REAR TIRE.
2. ALL FLASHERS AND 360° ROTATING TOP MOUNTED BEACON SHALL BE ENGAGED.
3. FLASHING ARROW BOARD SHOULD BE ENGAGED IN NEUTRAL LIGHT POSITION IF AVAILABLE.
4. IF WORK IS CLASSIFIED AS SHORT OR LONG DURATION USE LAYOUT 750-7.

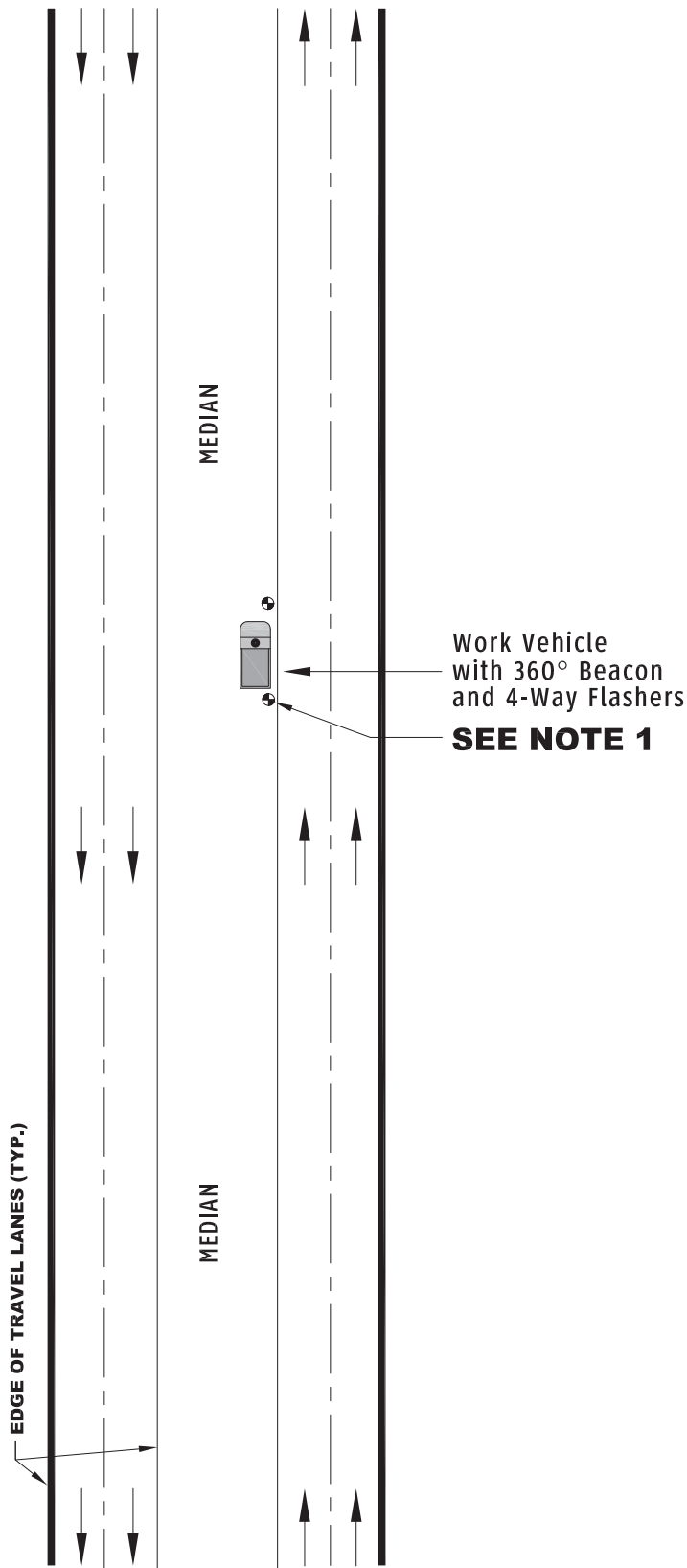

750-6

TRAFFIC CONTROL MANUAL

2018

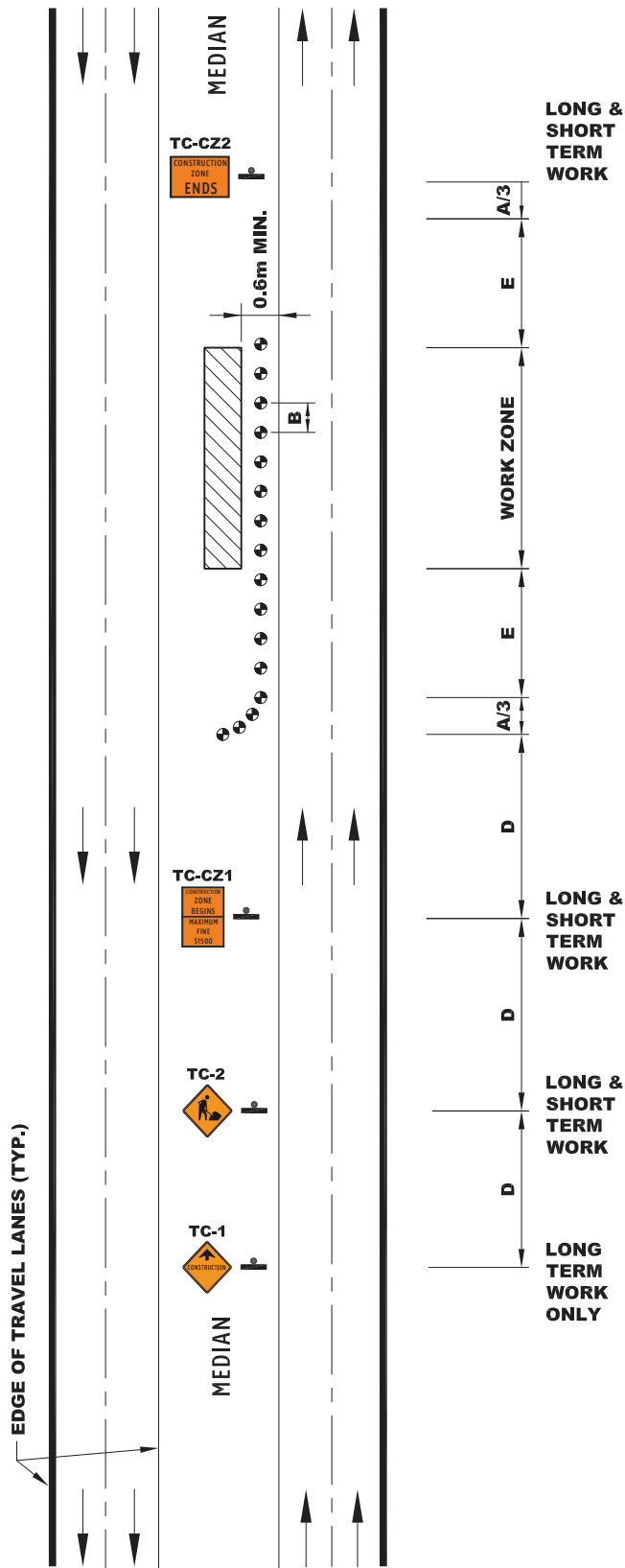

NOTES

WORK ZONE DIMENSIONS FOR WORK ADJACENT TO ROADWAY LEFT SHOULDER MULTI-LANE DIVIDED ALL DURATIONS ALL VOLUMES

DIMENSION (m)	NORMAL POSTED REGULATORY SPEED					
	50	60	70	80	90	100
A	30	40	60	90	110	180
B	5/8	8/12	10/15	10/15	12/18	15/20
C	30	40	40	50	50	50
D	50	50	75	100	100	150
E	35	50	50	75	75	75

POSTED SPEED IS EXISTING SPEED LIMIT (km/h)

A - TAPER LANE WHEN NO LANE CONTROL PRESENT

B - MAX. DELINEATOR SPACING IN TAPER/WORK ZONE

C - TRAFFIC CONTROL PERSON SETBACK (m)

D - DISTANCE BETWEEN CONSTRUCTION SIGNS

E - BUFFER AREA LENGTH BETWEEN TAPER AND WORK ZONE

NOTES

1. WHERE A FLAGPERSON IS PRESENT FOR THIS OPERATION, SIGN AS PER FORM 752-10 OR 752-12 OR 752-17 AS APPROPRIATE.

2. WHERE A FLAGPERSON IS PRESENT FOR THIS OPERATION SIGN SIMILARLY AS PER FORM 752-6 OR ALTERNATIVELY AS 752-10 OR 752-12 OR 752-17 AS APPROPRIATE.

750-7

TRAFFIC CONTROL MANUAL

2018

NOTES

1. WHERE THE DURATION OF THIS ACTIVITY IS DEFINED AS "VERY SHORT TERM WORK" REQUIRING A PERSON TO EXIT THE VEHICLE TWO WEIGHTED TRAFFIC CONES SHALL BE PLACED NEXT TO THE FRONT AND REAR TIRE.
2. ALL FLASHERS AND 360° ROTATING TOP MOUNTED BEACON SHALL BE ENGAGED.
3. FLASHING ARROW BOARD SHOULD BE ENGAGED IN NEUTRAL LIGHT POSITION IF AVAILABLE.
4. IF WORK IS CLASSIFIED AS VERY SHORT, SHORT OR LONG DURATION USE LAYOUT 750-9.

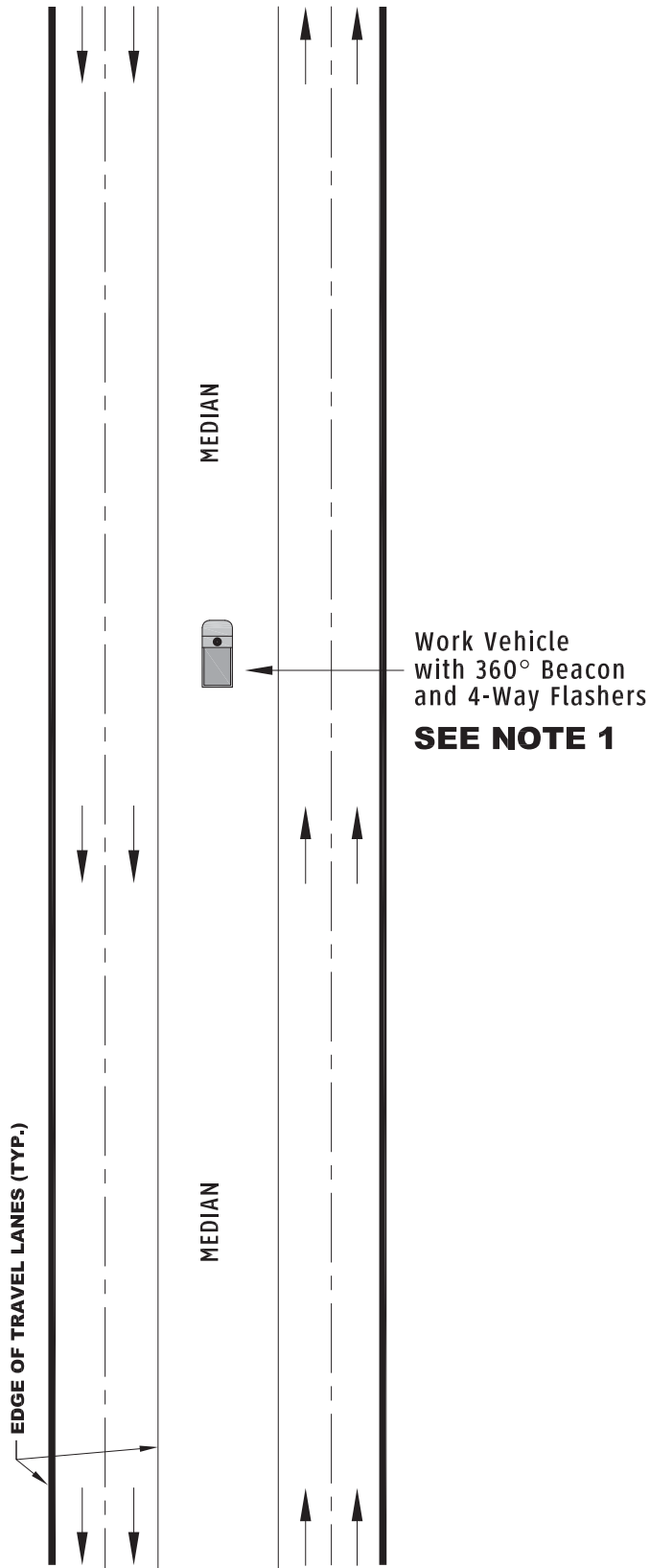

750-8

TRAFFIC CONTROL MANUAL 2018

NOTES

WORK ZONE DIMENSIONS FOR WORK IN MEDIAN OR ADJACENT TO ROADWAY LEFT SHOULDER MULTI-LANE DIVIDED ALL DURATIONS ALL VOLUMES						
NORMAL POSTED REGULATORY SPEED						
DIMENSION (m)	50	60	70	80	90	100
A	30	40	60	90	110	180
B	5/8	8/12	10/15	10/15	12/18	15/20
C	30	40	40	50	50	50
D	50	50	75	100	100	150
E	35	50	50	75	75	75

POSTED SPEED IS EXISTING SPEED LIMIT (km/h)

A - TAPER LANE WHEN NO LANE CONTROL PRESENT

B - MAX. DELINEATOR SPACING IN TAPER/WORK ZONE

C - TRAFFIC CONTROL PERSON SETBACK (m)

D - DISTANCE BETWEEN CONSTRUCTION SIGNS

E - BUFFER AREA LENGTH BETWEEN TAPER AND WORK ZONE

NOTES

1. SIGN OPPOSITE APPROACH IN THE SAME MANNER.
2. WHERE A FLAGPERSON IS PRESENT FOR THIS OPERATION, SIGN SIMILARLY AS PER FORM 752-6 OR ALTERNATIVELY USE SIGN LAYOUTS 752-10 OR 752-12 OR 752-17 FOR THIS OPERATION OR AS OTHERWISE APPROPRIATE.

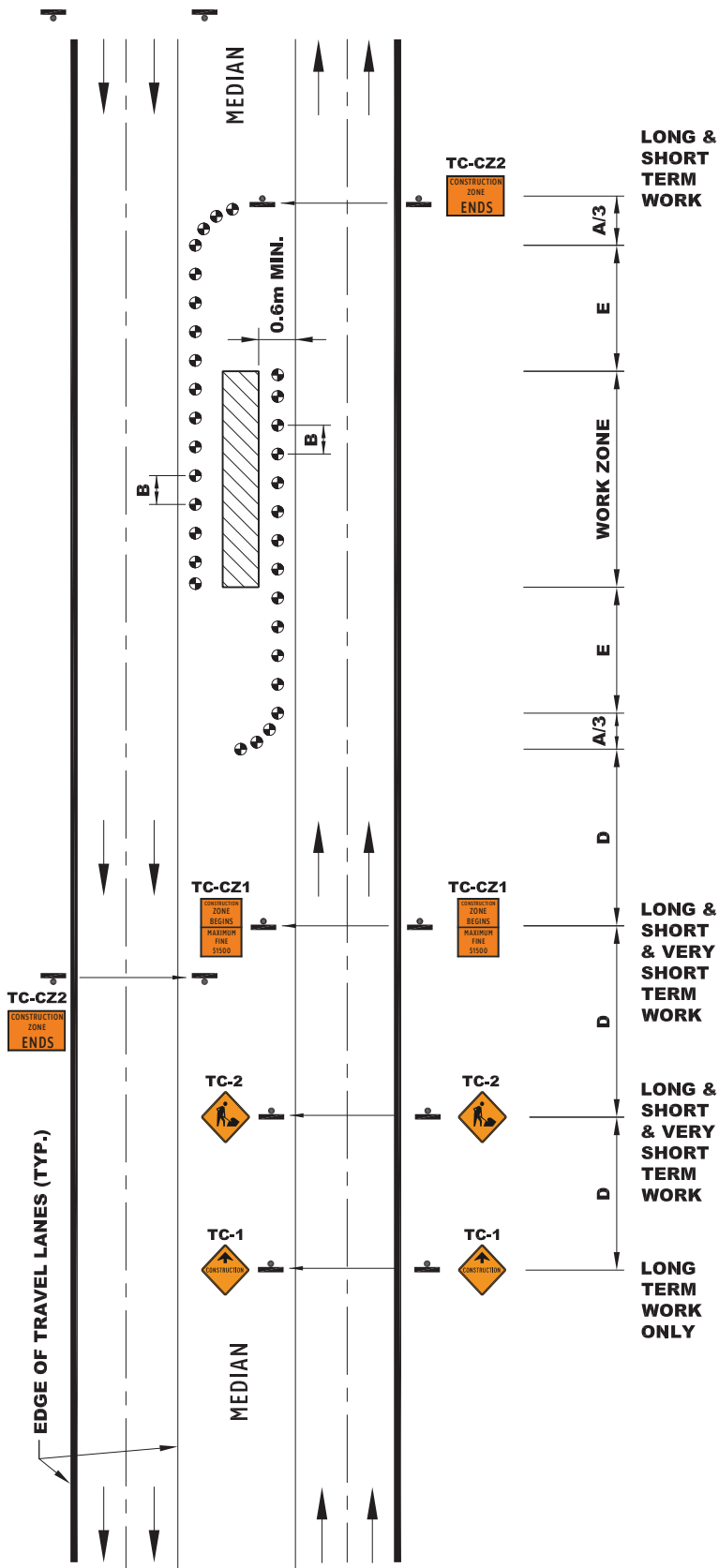

750-9

TRAFFIC CONTROL MANUAL 2018

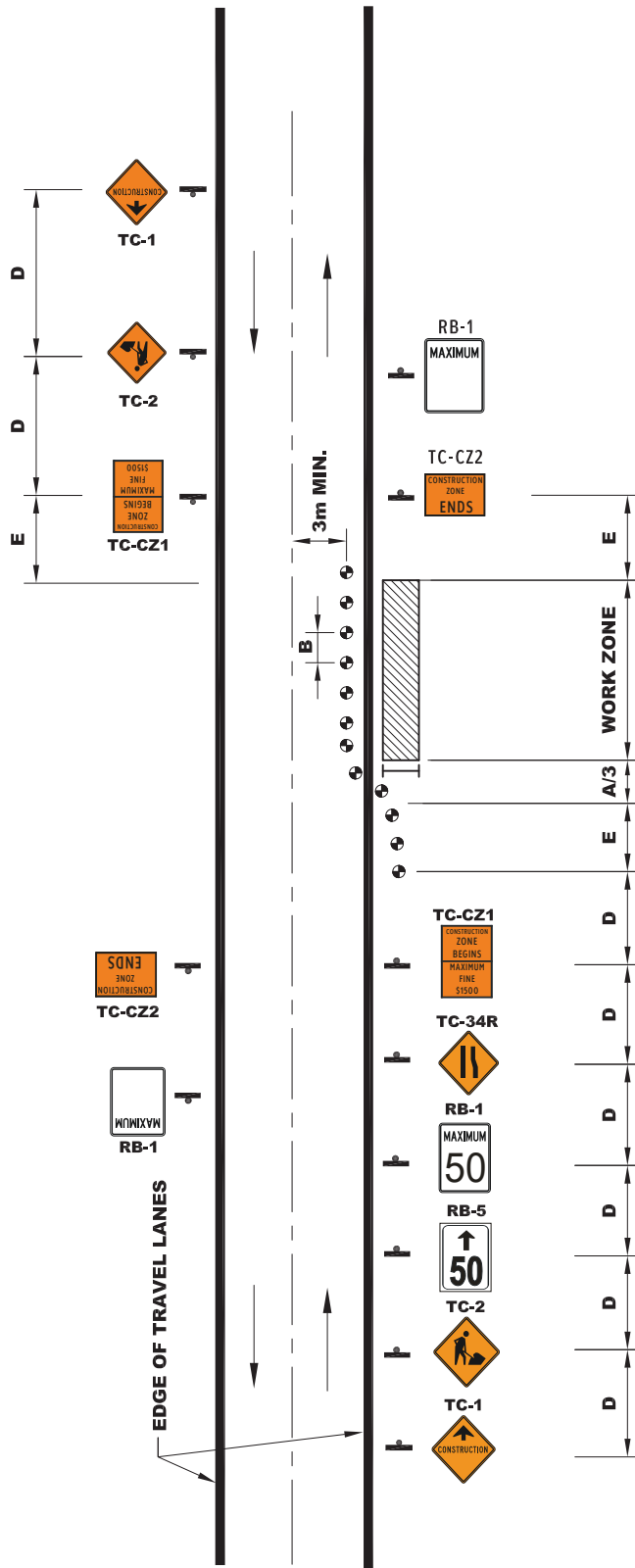

WORK ZONE DIMENSIONS FOR WORK AT EDGE OF ROADWAY ENCROACHMENT IN RIGHT LANE

DIMENSION (m)	NORMAL POSTED REGULATORY SPEED					
	50	60	70	80	90	100
A	30	40	60	90	110	180
B	5/8	8/12	10/15	10/15	12/18	15/20
C	30	40	40	50	50	50
D	50	50	75	100	100	150
E	35	50	50	75	75	75

POSTED SPEED IS EXISTING SPEED LIMIT (km/h)

- A - TAPER LANE WHEN NO LANE CONTROL PRESENT
- B - MAX. DELINEATOR SPACING IN TAPER/WORK ZONE
- C - TRAFFIC CONTROL PERSON SETBACK (m)
- D - DISTANCE BETWEEN CONSTRUCTION SIGNS
- E - BUFFER AREA LENGTH BETWEEN TAPER AND WORK ZONE

NOTES

1. WHERE THE EXISTING SPEED LIMIT IS 50 km/h OR LESS, SPEED SIGNS ARE NOT REQUIRED.
2. WHERE A FLAGPERSON IS PRESENT FOR THIS OPERATION SIGN AS PER FORM 752-1 OR 752-2 AS APPROPRIATE.
3. CONES OR DELINEATOR POSTS MAY BE SUBSTITUTED WITH DRUMS.

751-1

TRAFFIC CONTROL MANUAL 2018

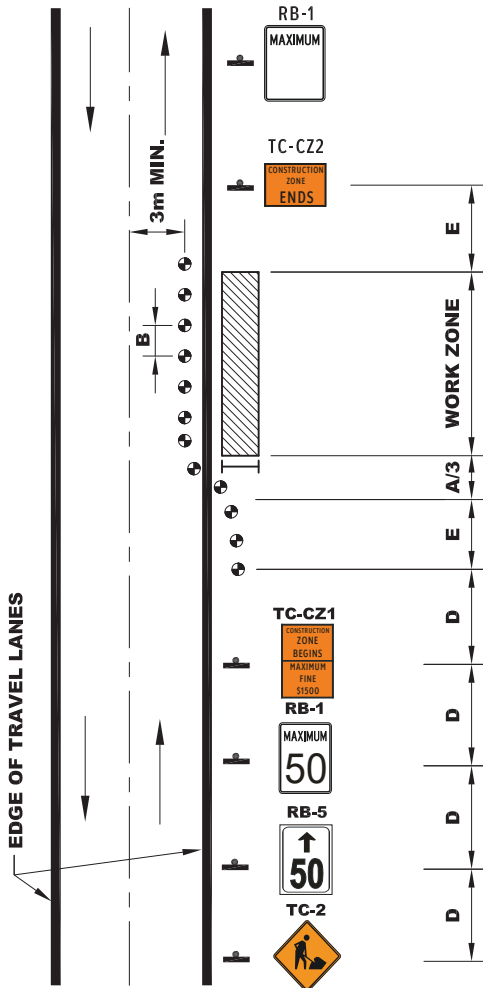

OR

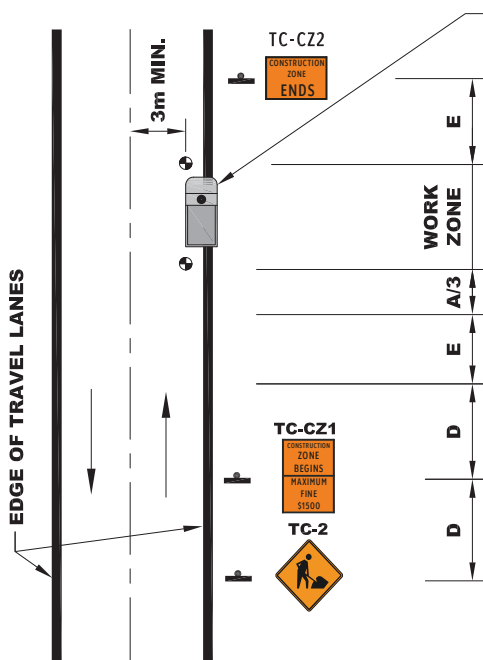

WORK ZONE DIMENSIONS FOR WORK AT EDGE OF ROADWAY ENCROACHMENT IN RIGHT LANE VERY SHORT AND SHORT TERM

DIMENSION (m)	NORMAL POSTED REGULATORY SPEED					
	50	60	70	80	90	100
A	30	40	60	90	110	180
B	5/8	8/12	10/15	10/15	12/18	15/20
C	30	40	40	50	50	50
D	50	50	75	100	100	150
E	35	50	50	75	75	75

POSTED SPEED IS EXISTING SPEED LIMIT (km/h)

A - TAPER LANE WHEN NO LANE CONTROL PRESENT

B - MAX. DELINEATOR SPACING IN TAPER/WORK ZONE

C - TRAFFIC CONTROL PERSON SETBACK (m)

D - DISTANCE BETWEEN CONSTRUCTION SIGNS

E - BUFFER AREA LENGTH BETWEEN TAPER AND WORK ZONE

NOTES

1. WHERE THE DURATION OF THIS ACTIVITY IS DEFINED AS "VERY SHORT TERM WORK" REQUIRING A PERSON TO EXIT THE VEHICLE TWO WEIGHTED TRAFFIC CONES SHALL BE PLACED NEXT TO THE FRONT AND REAR TIRE.
2. ALL FLASHERS AND 360° ROTATING TOP MOUNTED BEACON SHALL BE ENGAGED.
3. FLASHING ARROW BOARD SHOULD BE ENGAGED IN NEUTRAL LIGHT POSITION IF AVAILABLE.
4. WHERE THE EXISTING SPEED LIMIT IS 50 km/h OR LESS, SPEED SIGNS ARE NOT REQUIRED.
5. WHERE A FLAGPERSON IS PRESENT FOR THIS OPERATION SIGN AS PER FORM 752-1 OR 752-2 AS APPROPRIATE.
6. CONES OR DELINEATOR POSTS MAY BE SUBSTITUTED WITH DRUMS.

751-2

TRAFFIC CONTROL MANUAL

2018

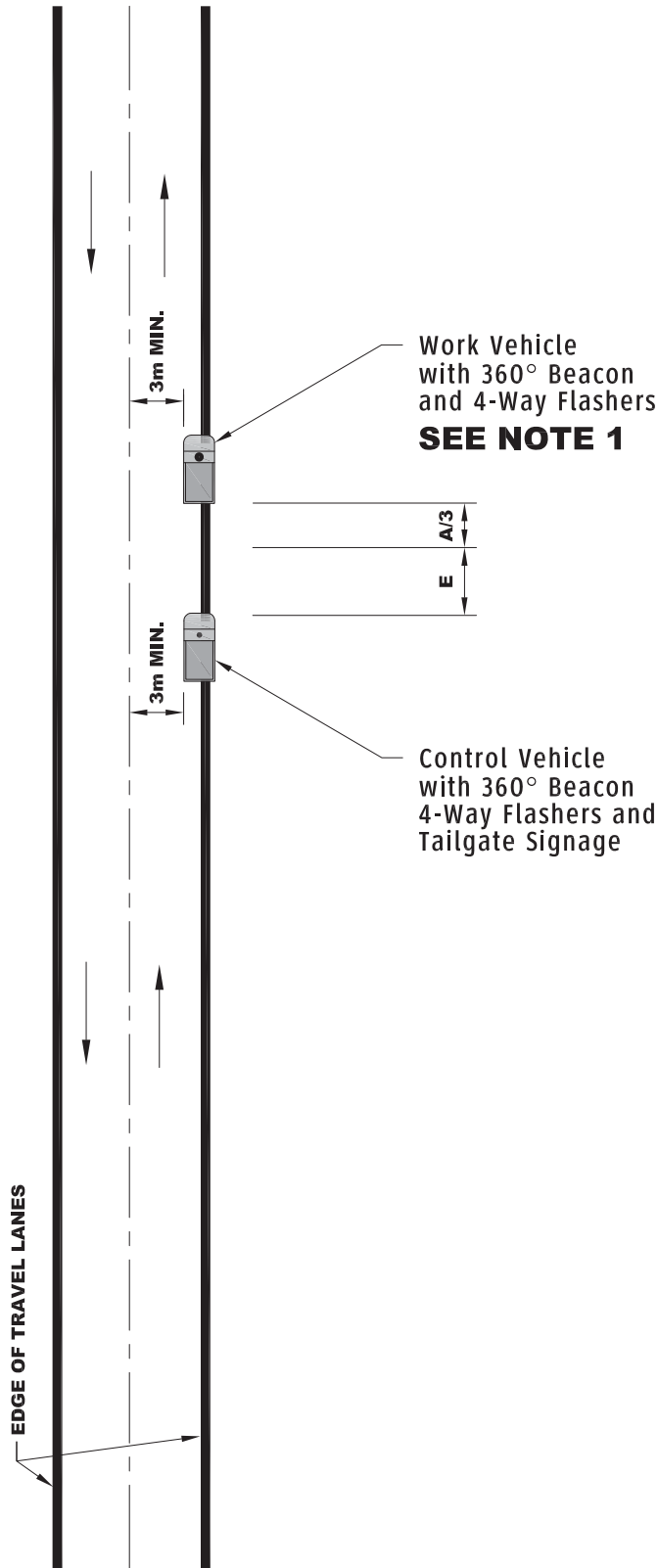

WORK ZONE DIMENSIONS FOR WORK AT EDGE OF ROADWAY ENCROACHMENT IN RIGHT LANE MOBILE OPERATIONS

DIMENSION (m)	NORMAL POSTED REGULATORY SPEED					
	50	60	70	80	90	100
A	30	40	60	90	110	180
B	5/8	8/12	10/15	10/15	12/18	15/20
C	30	40	40	50	50	50
D	50	50	75	100	100	150
E	35	50	50	75	75	75

POSTED SPEED IS EXISTING SPEED LIMIT (km/h)

- A - TAPER LANE WHEN NO LANE CONTROL PRESENT
- B - MAX. DELINEATOR SPACING IN TAPER/WORK ZONE
- C - TRAFFIC CONTROL PERSON SETBACK (m)
- D - DISTANCE BETWEEN CONSTRUCTION SIGNS
- E - BUFFER AREA LENGTH BETWEEN TAPER AND WORK ZONE

NOTES

1. WHERE THIS ACTIVITY REQUIRES A PERSON TO TEMPORARILY EXIT THE VEHICLE TWO WEIGHTED TRAFFIC CONES SHALL BE PLACED NEXT TO THE FRONT AND REAR TIRE.
2. ALL FLASHERS AND 360° ROTATING TOP MOUNTED BEACON SHALL BE ENGAGED.
3. FLASHING ARROW BOARD SHOULD BE ENGAGED IN NEUTRAL LIGHT POSITION IF AVAILABLE.
4. WHERE A FLAGPERSON IS PRESENT FOR THIS OPERATION SIGN AS PER FORM 752-1 OR 752-2 AS APPROPRIATE.

751-3

TRAFFIC CONTROL MANUAL 2018

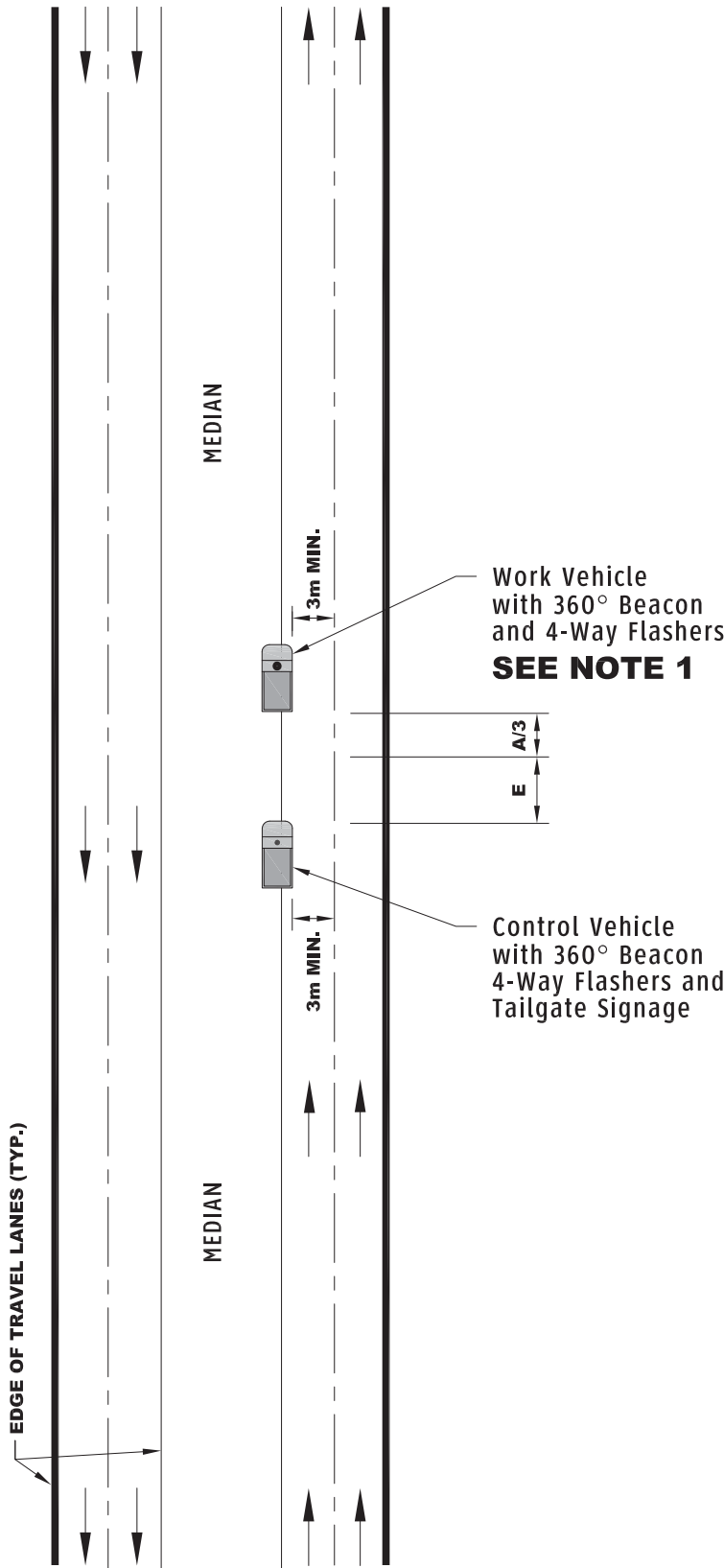

WORK ZONE DIMENSIONS FOR WORK AT EDGE OF ROADWAY ENCROACHMENT IN LEFT LANE DIVIDED HWY. MOBILE OPERATIONS

DIMENSION (m)	NORMAL POSTED REGULATORY SPEED					
	50	60	70	80	90	100
A	30	40	60	90	110	180
B	5/8	8/12	10/15	10/15	12/18	15/20
C	30	40	40	50	50	50
D	50	50	75	100	100	150
E	35	50	50	75	75	75

POSTED SPEED IS EXISTING SPEED LIMIT (km/h)

- A - TAPER LANE WHEN NO LANE CONTROL PRESENT
- B - MAX. DELINEATOR SPACING IN TAPER/WORK ZONE
- C - TRAFFIC CONTROL PERSON SETBACK (m)
- D - DISTANCE BETWEEN CONSTRUCTION SIGNS
- E - BUFFER AREA LENGTH BETWEEN TAPER AND WORK ZONE

NOTES

1. WHERE THIS ACTIVITY REQUIRES A PERSON TO TEMPORARILY EXIT THE VEHICLE TWO WEIGHTED TRAFFIC CONES SHALL BE PLACED NEXT TO THE FRONT AND REAR TIRE.
2. ALL FLASHERS AND 360° ROTATING TOP MOUNTED BEACON SHALL BE ENGAGED.
3. FLASHING ARROW BOARD SHOULD BE ENGAGED IN NEUTRAL LIGHT POSITION IF AVAILABLE
4. WHERE A FLAGPERSON IS PRESENT FOR THIS OPERATION SIGN AS PER FORM 752-1 OR 752-2 AS APPROPRIATE.

751-4

TRAFFIC CONTROL MANUAL 2018

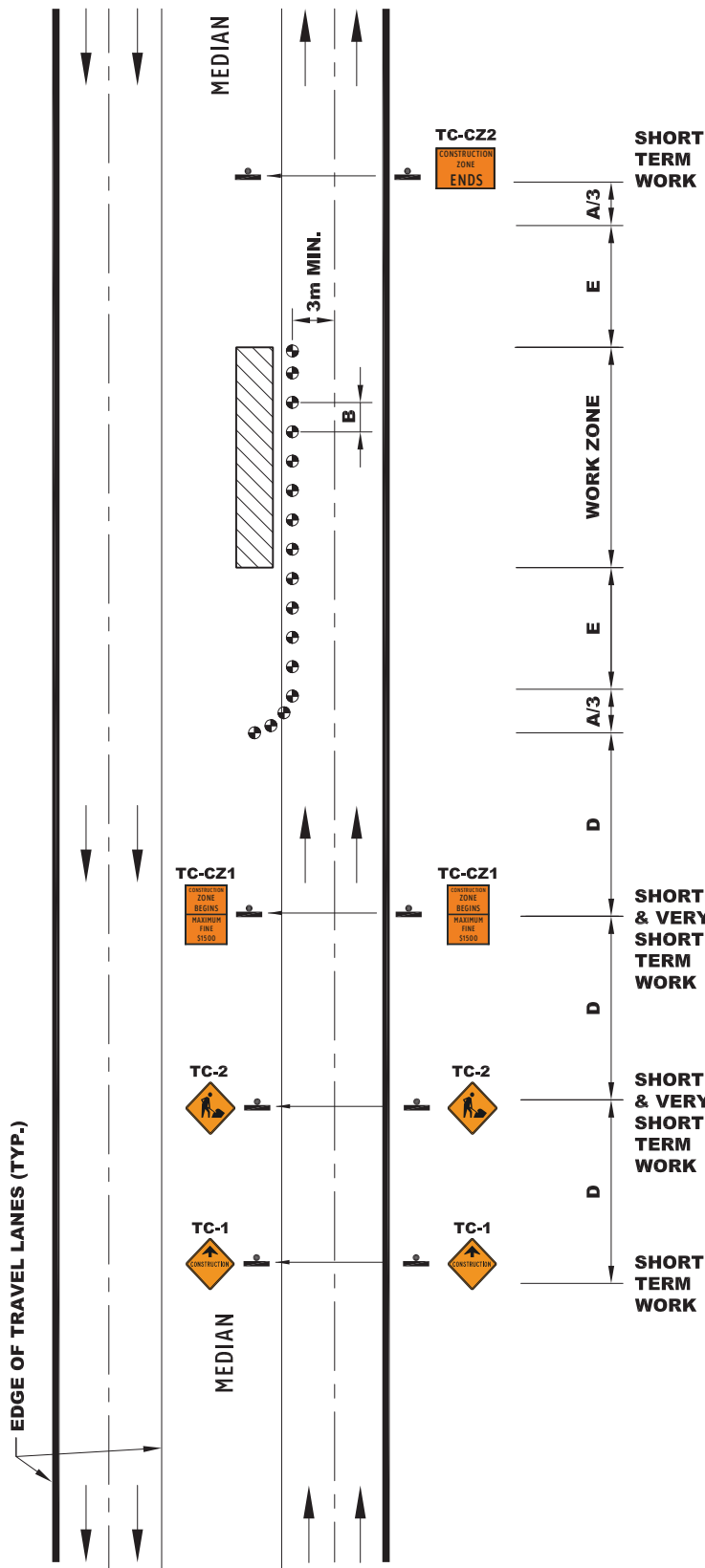

WORK ZONE DIMENSIONS FOR WORK ON MULTI-LANE ROADWAY LEFT LANE VERY SHORT & SHORT DURATIONS DIVIDED HIGHWAY						
DIMENSION (m)	NORMAL POSTED REGULATORY SPEED					
	50	60	70	80	90	100
A	30	40	60	90	110	180
B	5/8	8/12	10/15	10/15	12/18	15/20
C	30	40	40	50	50	50
D	50	50	75	100	100	150
E	35	50	50	75	75	75

POSTED SPEED IS EXISTING SPEED LIMIT (km/h)

A - TAPER LANE WHEN NO LANE CONTROL PRESENT

B - MAX. DELINEATOR SPACING IN TAPER/WORK ZONE

C - TRAFFIC CONTROL PERSON SETBACK (m)

D - DISTANCE BETWEEN CONSTRUCTION SIGNS

E - BUFFER AREA LENGTH BETWEEN TAPER AND WORK ZONE

NOTES

1. WHERE THE DURATION OF THIS ACTIVITY IS DEFINED AS "SHORT TERM WORK" WITH HIGH SPEED AND HIGH VOLUME A VARIABLE MESSAGE SIGN FOR MORE EFFECTIVENESS IS RECOMMENDED.
2. SIGN OPPOSITE APPROACH IN THE SAME MANNER.
3. WHERE A FLAGPERSON IS PRESENT FOR THIS OPERATION SIGN SIMILARLY AS PER FORM 752-6 OR ALTERNATIVELY AS 752-10 OR 752-12 OR 752-17 AS APPROPRIATE.
4. WHERE THE EXISTING SPEED LIMIT IS 50 km/h OR LESS, SPEED SIGNS ARE NOT REQUIRED. REDUCE POSTED SPEED IF HAZARD ASSESSMENT INDICATES SPEED REDUCTION REQUIRED.

751-5

TRAFFIC CONTROL MANUAL 2018

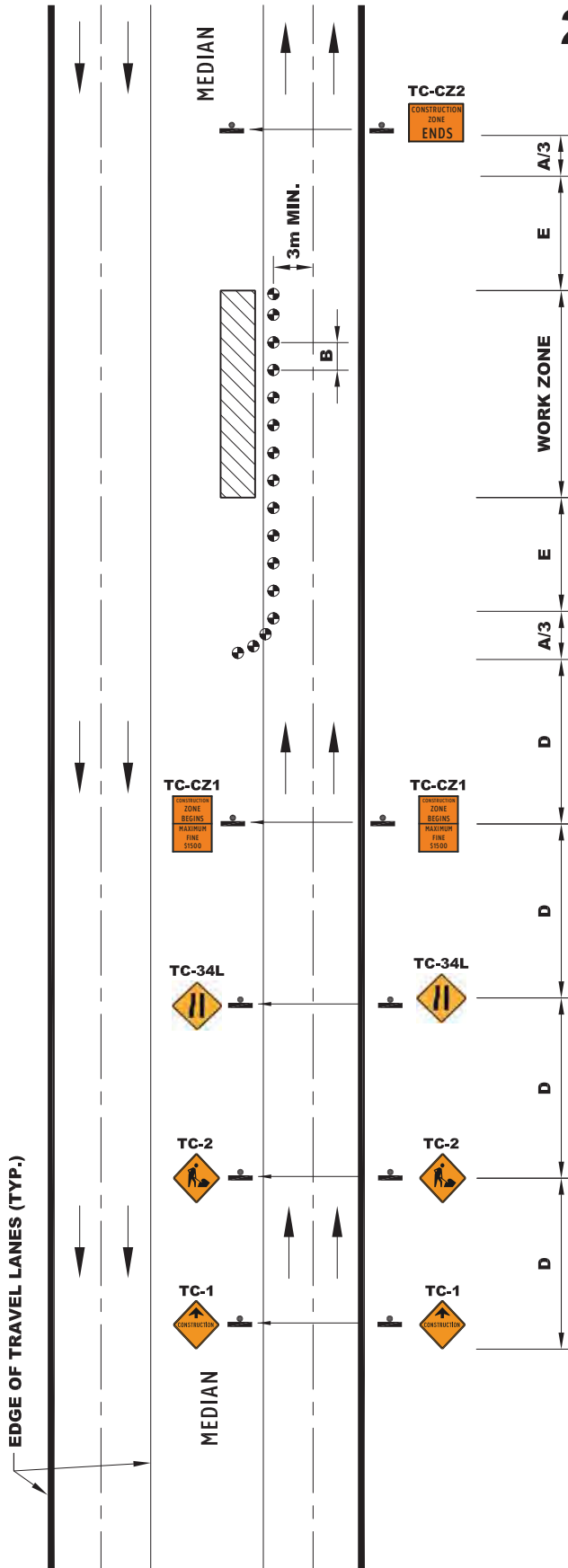

WORK ZONE DIMENSIONS FOR WORK ON MULTI-LANE ROADWAY LEFT LANE LONG DURATION DIVIDED HIGHWAY

DIMENSION (m)	NORMAL POSTED REGULATORY SPEED					
	50	60	70	80	90	100
A	30	40	60	90	110	180
B	5/8	8/12	10/15	10/15	12/18	15/20
C	30	40	40	50	50	50
D	50	50	75	100	100	150
E	35	50	50	75	75	75

POSTED SPEED IS EXISTING SPEED LIMIT (km/h)

A - TAPER LANE WHEN NO LANE CONTROL PRESENT

B - MAX. DELINEATOR SPACING IN TAPER/WORK ZONE

C - TRAFFIC CONTROL PERSON SETBACK (m)

D - DISTANCE BETWEEN CONSTRUCTION SIGNS

E - BUFFER AREA LENGTH BETWEEN TAPER AND WORK ZONE

NOTES

- WHERE THE EXISTING SPEED LIMIT IS 50 km/h OR LESS, SPEED SIGNS ARE NOT REQUIRED. REDUCE POSTED SPEED IF HAZARD ASSESSMENT INDICATES SPEED REDUCTION REQUIRED.
- WHERE A FLAGPERSON IS PRESENT FOR THIS OPERATION SIGN SIMILARLY AS PER FORM 752-6 OR ALTERNATIVELY AS 752-10 OR 752-12 OR 752-17 AS APPROPRIATE.
- CONES OR DELINEATOR POSTS MAY BE SUBSTITUTED WITH DRUMS.

751-6



TRANSPORTATION AND WORKS
HIGHWAY DESIGN DIVISION

MULTI-LANE ROAD - ENCROACHMENT IN LEFT LANE - LONG DURATION DIVIDED HIGHWAY

DRAWN BY: JM

DATE: Rev November 2018 NOT TO SCALE

TRAFFIC CONTROL MANUAL 2018

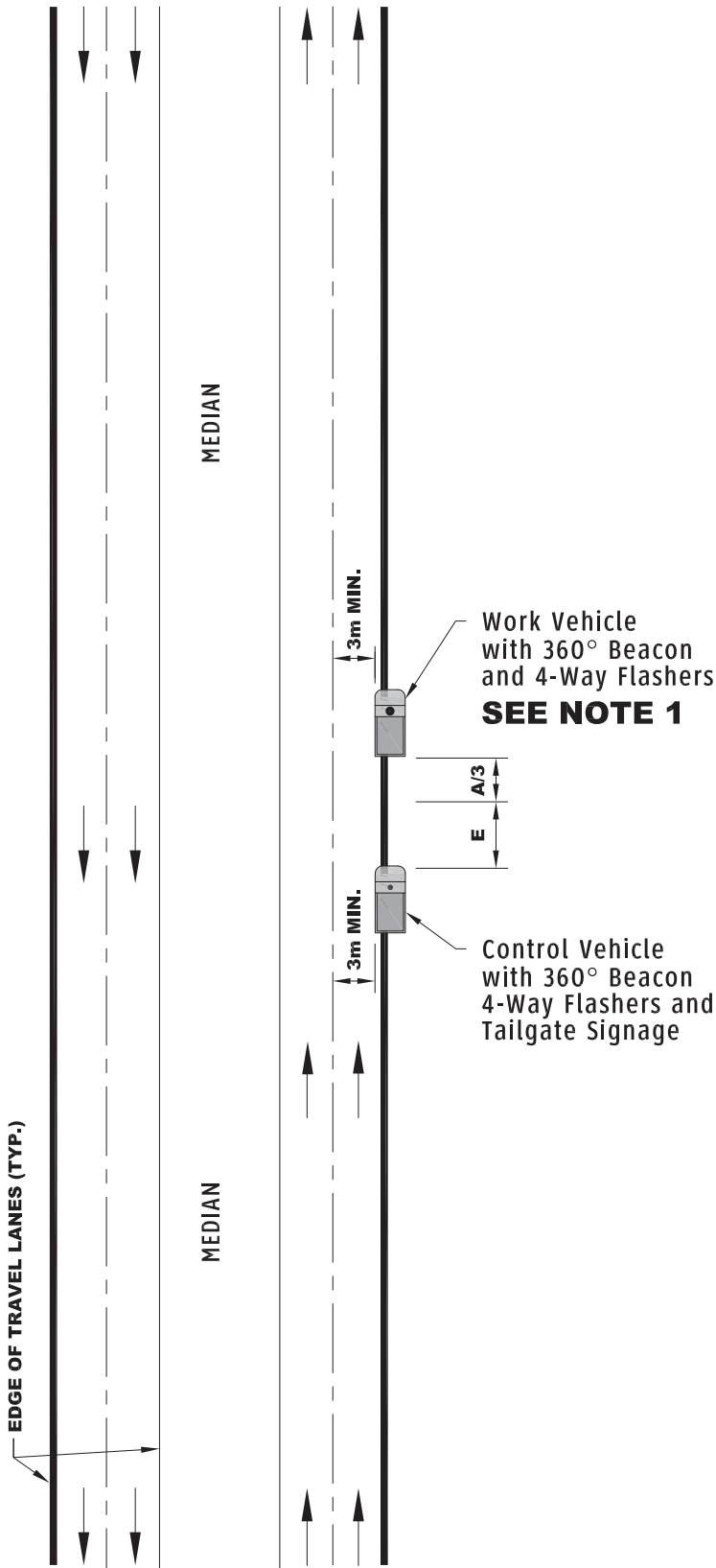

WORK ZONE DIMENSIONS FOR WORK AT EDGE OF ROADWAY ENCROACHMENT IN RIGHT LANE MOBILE OPERATIONS DIVIDED & UNDIVIDED HWY.

DIMENSION (m)	NORMAL POSTED REGULATORY SPEED					
	50	60	70	80	90	100
A	30	40	60	90	110	180
B	5/8	8/12	10/15	10/15	12/18	15/20
C	30	40	40	50	50	50
D	50	50	75	100	100	150
E	35	50	50	75	75	75

POSTED SPEED IS EXISTING SPEED LIMIT (km/h)

A - TAPER LANE WHEN NO LANE CONTROL PRESENT

B - MAX. DELINEATOR SPACING IN TAPER/WORK ZONE

C - TRAFFIC CONTROL PERSON SETBACK (m)

D - DISTANCE BETWEEN CONSTRUCTION SIGNS

E - BUFFER AREA LENGTH BETWEEN TAPER AND WORK ZONE

NOTES

1. WHERE THIS ACTIVITY REQUIRES A PERSON TO TEMPORARILY EXIT THE VEHICLE TWO WEIGHTED TRAFFIC CONES SHALL BE PLACED NEXT TO THE FRONT AND REAR TIRE.
2. ALL FLASHERS AND 360° ROTATING TOP MOUNTED BEACON SHALL BE ENGAGED.
3. FLASHING ARROW BOARD SHOULD BE ENGAGED IN NEUTRAL LIGHT POSITION IF AVAILABLE.
4. WHERE THE EXISTING SPEED LIMIT IS 50 km/h OR LESS, SPEED SIGNS ARE NOT REQUIRED. REDUCE POSTED SPEED IF HAZARD ASSESSMENT INDICATES SPEED REDUCTION REQUIRED.

751-7



TRANSPORTATION AND WORKS
HIGHWAY DESIGN DIVISION

MULTI-LANE ROAD - ENCROACHMENT IN RIGHT LANE - MOBILE OPERATIONS DIVIDED OR UNDIVIDED HIGHWAY

DRAWN BY: JM

DATE: Rev November 2018 NOT TO SCALE

TRAFFIC CONTROL MANUAL 2018

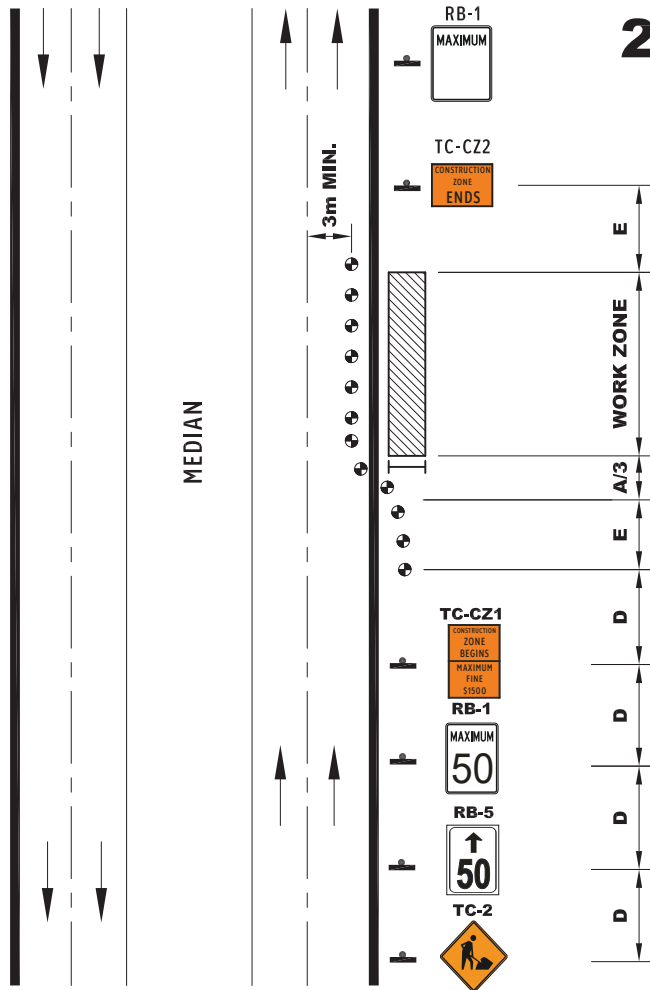

WORK ZONE DIMENSIONS FOR MULTI-LANE ROAD ENCROACHMENT IN RIGHT LANE VERY SHORT AND SHORT TERM DIVIDED OR UNDIVIDED HIGHWAY						
DIMENSION (m)	NORMAL POSTED REGULATORY SPEED					
	50	60	70	80	90	100
A	30	40	60	90	110	180
B	5/8	8/12	10/15	10/15	12/18	15/20
C	30	40	40	50	50	50
D	50	50	75	100	100	150
E	35	50	50	75	75	75

POSTED SPEED IS EXISTING SPEED LIMIT (km/h)

A - TAPER LANE WHEN NO LANE CONTROL PRESENT

B - MAX. DELINEATOR SPACING IN TAPER/WORK ZONE

C - TRAFFIC CONTROL PERSON SETBACK (m)

D - DISTANCE BETWEEN CONSTRUCTION SIGNS

E - BUFFER AREA LENGTH BETWEEN TAPER AND WORK ZONE

OR

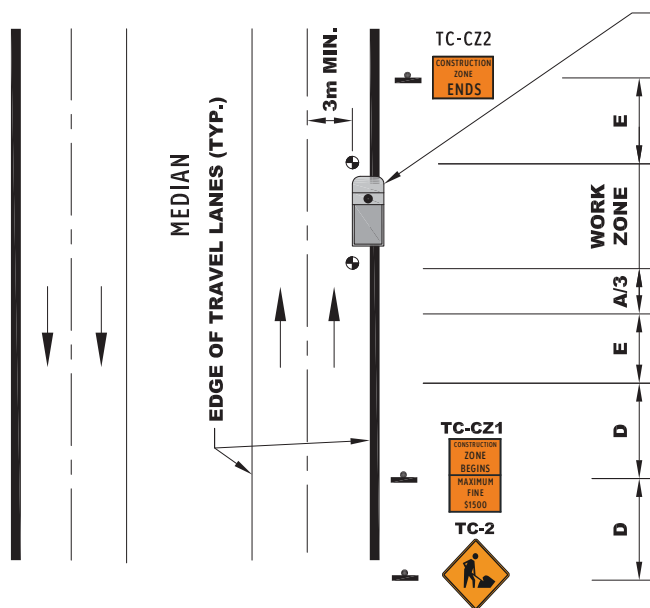

Work Vehicle with 360° Beacon and 4-Way Flashers

SEE NOTE 1

NOTES

1. WHERE THE DURATION OF THIS ACTIVITY IS DEFINED AS "VERY SHORT TERM WORK" REQUIRING A PERSON TO EXIT THE VEHICLE TWO WEIGHTED TRAFFIC CONES SHALL BE PLACED NEXT TO THE FRONT AND REAR TIRE .
2. ALL FLASHERS AND 360° ROTATING TOP MOUNTED BEACON SHALL BE ENGAGED.
3. FLASHING ARROW BOARD SHOULD BE ENGAGED IN NEUTRAL LIGHT POSITION IF AVAILABLE.
4. WHERE THE EXISTING SPEED LIMIT IS 50 km/h OR LESS, SPEED SIGNS ARE NOT REQUIRED.
5. WHERE A FLAGPERSON IS PRESENT FOR THIS OPERATION SIGN AS PER FORM 752-6 AS APPROPRIATE.
6. CONES OR DELINEATOR POSTS MAY BE SUBSTITUTED WITH DRUMS.

751-8

TRAFFIC CONTROL MANUAL 2018

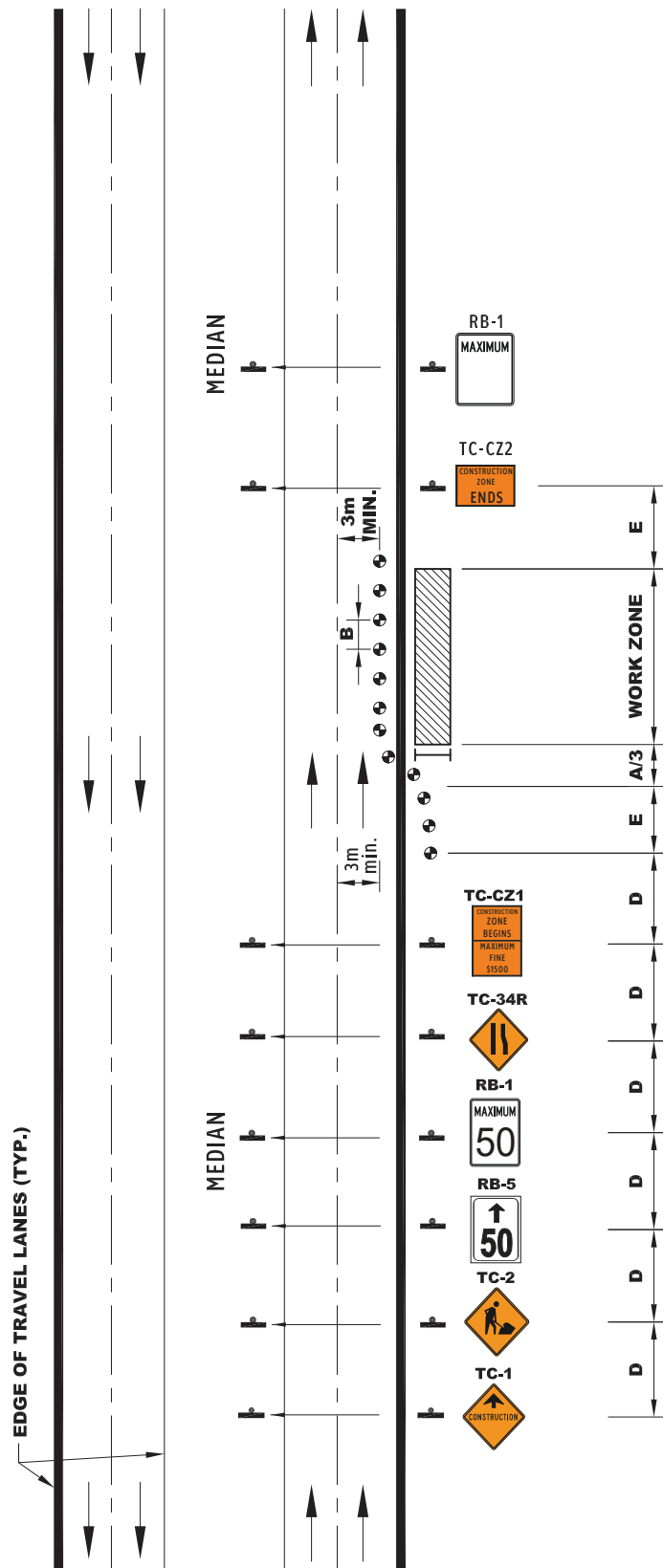

WORK ZONE DIMENSIONS FOR MULTI-LANE ROAD ENCROACHMENT IN RIGHT LANE LONG TERM WORK DIVIDED OR UNDIVIDED HIGHWAY						
DIMENSION (m)	NORMAL POSTED REGULATORY SPEED					
	50	60	70	80	90	100
A	30	40	60	90	110	180
B	5/8	8/12	10/15	10/15	12/18	15/20
C	30	40	40	50	50	50
D	50	50	75	100	100	150
E	35	50	50	75	75	75

POSTED SPEED IS EXISTING SPEED LIMIT (km/h)

- A - TAPER LANE WHEN NO LANE CONTROL PRESENT
- B - MAX. DELINEATOR SPACING IN TAPER/WORK ZONE
- C - TRAFFIC CONTROL PERSON SETBACK (m)
- D - DISTANCE BETWEEN CONSTRUCTION SIGNS
- E - BUFFER AREA LENGTH BETWEEN TAPER AND WORK ZONE

NOTES

1. WHERE THE EXISTING SPEED LIMIT IS 50 km/h OR LESS, SPEED SIGNS ARE NOT REQUIRED. REDUCE POSTED SPEED IF HAZARD ASSESSMENT INDICATES SPEED REDUCTION REQUIRED.
2. WHERE A FLAGPERSON IS PRESENT FOR THIS OPERATION SIGN AS PER FORM 752-15 AS APPROPRIATE.
3. CONES OR DELINEATOR POSTS MAY BE SUBSTITUTED WITH DRUMS.

751-9

TRAFFIC CONTROL MANUAL 2018

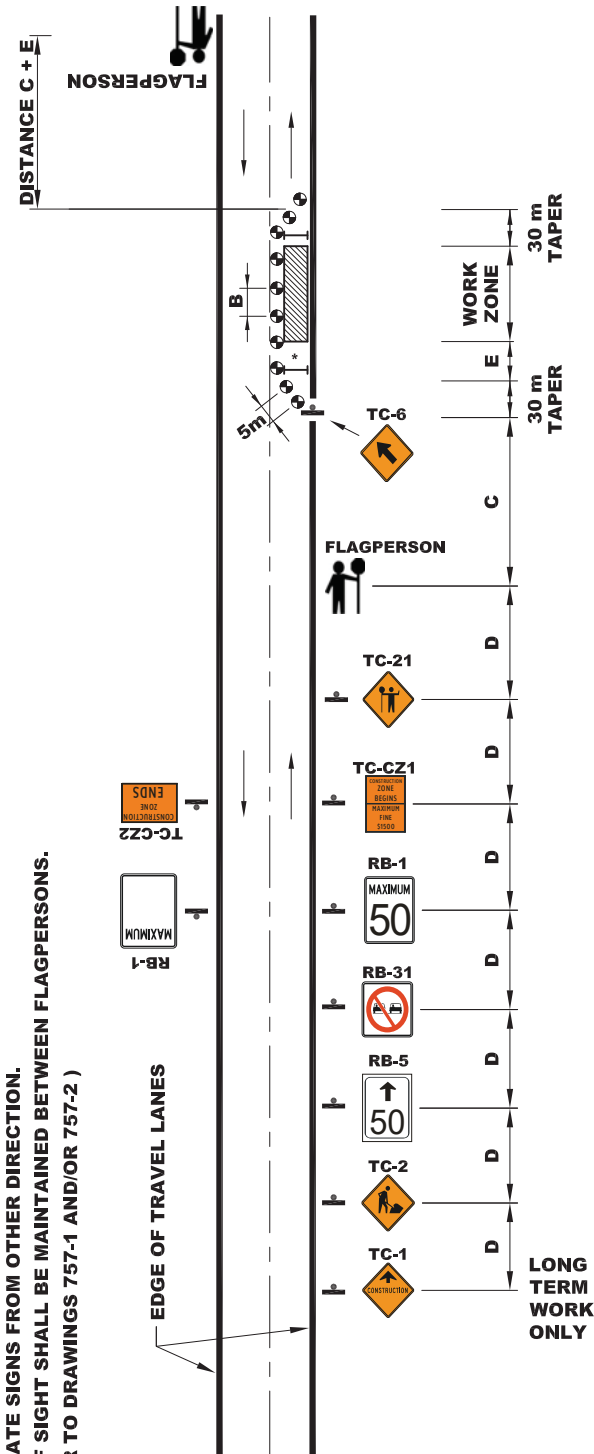

DUPLICATE SIGNS FROM OTHER DIRECTION.
LINE OF SIGHT SHALL BE MAINTAINED BETWEEN FLAGPERSONS.
(REFER TO DRAWINGS 757-1 AND/OR 757-2)

WORK ZONE DIMENSIONS FOR ONE LANE CLOSED SPEED LIMIT OVER 60 km/h

DIMENSION (m)	NORMAL POSTED REGULATORY SPEED			
	70	80	90	100
A	60	90	110	180
B	5/15	5/15	5/18	5/20
C	40	50	50	50
D	75	100	100	150
E	50	75	75	75

POSTED SPEED IS EXISTING SPEED LIMIT (km/h)

A - TAPER LANE WHEN NO LANE CONTROL PRESENT

B - MAX. DELINEATOR SPACING IN TAPER/WORK ZONE

C - TRAFFIC CONTROL PERSON SETBACK (m)

D - DISTANCE BETWEEN CONSTRUCTION SIGNS

E - BUFFER AREA LENGTH BETWEEN TAPER AND WORK ZONE

NOTES

1. DURING DARKNESS, THE FLAGPERSONS SHALL BE REPLACED BY PORTABLE TRAFFIC LIGHTS AND THE FLAGPERSON SIGNS, TC-21 SHALL BE REPLACED BY TRAFFIC LIGHTS AHEAD SIGNS, TC-181, REFER TO SECTION ON NIGHT WORK, PAGE 7.

* CONTROL VEHICLE WITH "FAB" OR STAND-ALONE FAB REQUIRED WHEN CLOSING A LANE ON A BRIDGE STRUCTURE.

752-1



TRANSPORTATION AND WORKS
HIGHWAY DESIGN DIVISION

ONE LANE CLOSED SPEED LIMIT GREATER THAN 60 km/h

DRAWN BY: G.Clarke

DATE: Rev November 2018

NOT TO SCALE

TRAFFIC CONTROL MANUAL 2018

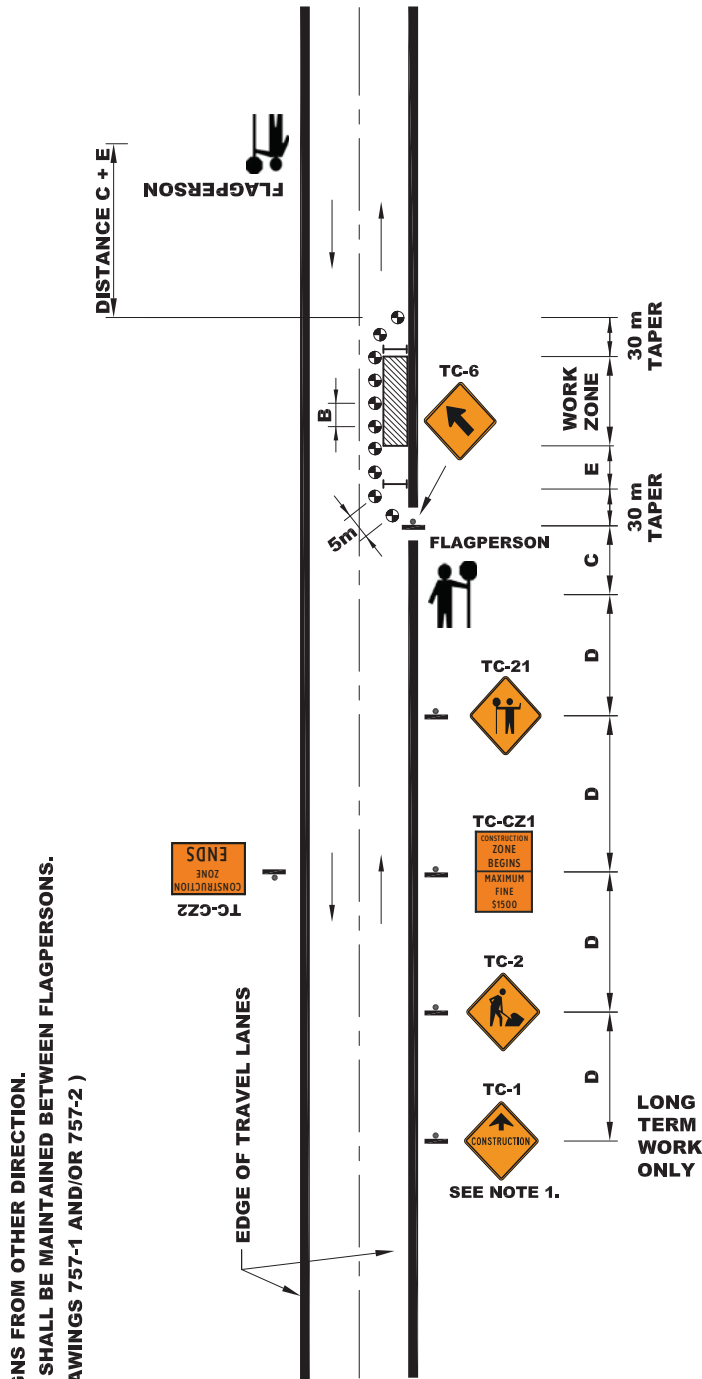

DUPLICATE SIGNS FROM OTHER DIRECTION.
 LINE OF SIGHT SHALL BE MAINTAINED BETWEEN FLAGPERSONS.
 (REFER TO DRAWINGS 757-1 AND/OR 757-2)

		NORMAL POSTED REGULATORY SPEED			
DIMENSION (m)	50	60			
A	30	40			
B	5/8	5/12			
C	30	40			
D	50	50			
E	35	50			

POSTED SPEED IS EXISTING SPEED LIMIT (km/h)

- A - TAPER LANE WHEN NO LANE CONTROL PRESENT
- B - MAX. DELINEATOR SPACING IN TAPER/WORK ZONE
- C - TRAFFIC CONTROL PERSON SETBACK (m)
- D - DISTANCE BETWEEN CONSTRUCTION SIGNS
- E - BUFFER AREA LENGTH BETWEEN TAPER AND WORK ZONE

NOTES

1. ONLY WHERE THE DURATION OF THIS ACTIVITY IS DEFINED AS "LONG TERM WORK" SIGN TC-1 SHALL BE INSTALLED
2. DURING DARKNESS, THE FLAGPERSONS SHALL BE REPLACED BY PORTABLE TRAFFIC LIGHTS AND THE FLAGPERSON SIGNS, TC-21 SHALL BE REPLACED BY TRAFFIC LIGHTS AHEAD SIGNS, TC-181, REFER TO SECTION ON NIGHT WORK, PAGE 7.

752-2

TRAFFIC CONTROL MANUAL 2018

DISTANCE C + E
TO BE MAINTAINED BETWEEN
THE FLAGPERSON AND THE WORKSITE
(MOBILE OPERATION)

DUPLICATE SIGNS FROM OTHER DIRECTION
(PAVING SPREADER, CRACK SEALING ETC.)
LINE OF SIGHT TO BE MAINTAINED BETWEEN FLAGPERSONS
REFER TO DRAWINGS 757-1 & 757-2

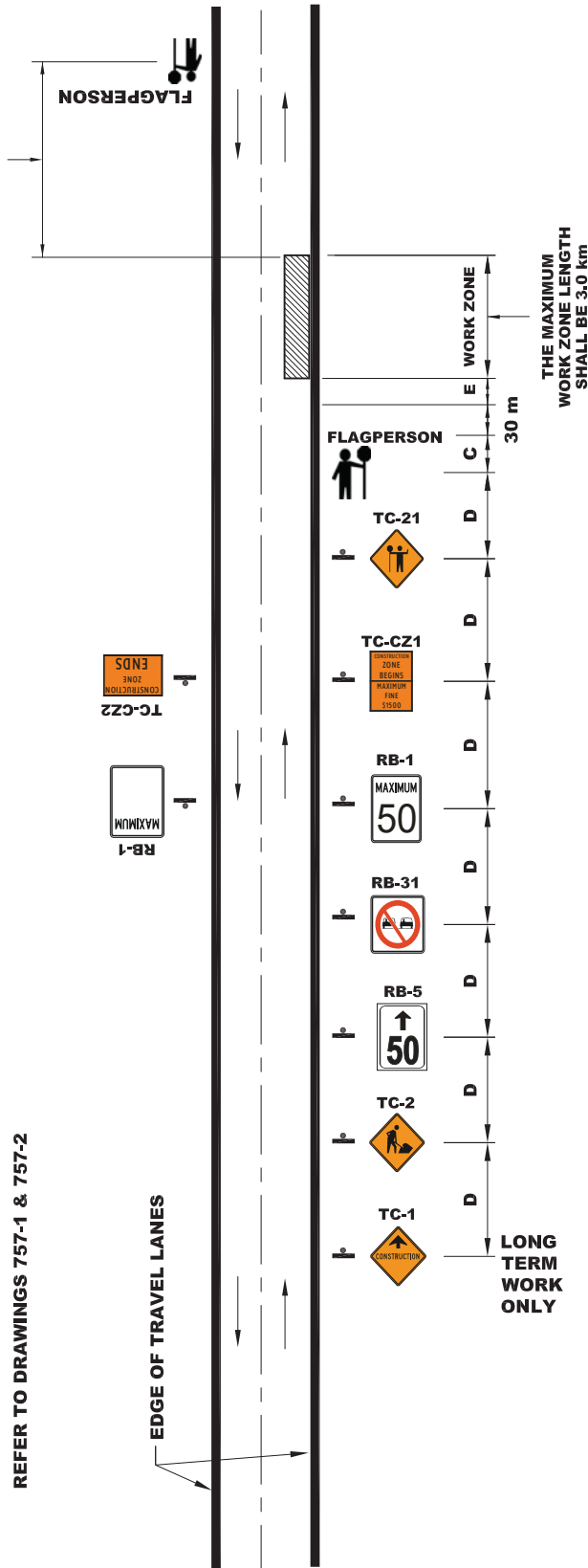

WORK ZONE DIMENSIONS FOR ONE LANE CLOSED SLOW MOVING OPERATIONS

DIMENSION (m)	NORMAL POSTED REGULATORY SPEED					
	50	60	70	80	90	100
A	30	40	60	90	110	180
B	5/8	8/12	10/15	10/15	12/18	15/20
C	30	40	40	50	50	50
D	50	50	75	100	100	150
E	35	50	50	75	75	75

POSTED SPEED IS EXISTING SPEED LIMIT (km/h)

- A - TAPER LANE WHEN NO LANE CONTROL PRESENT
- B - MAX. DELINEATOR SPACING IN TAPER/WORK ZONE
- C - TRAFFIC CONTROL PERSON SETBACK (m)
- D - DISTANCE BETWEEN CONSTRUCTION SIGNS
- E - BUFFER AREA LENGTH BETWEEN TAPER AND WORK ZONE

NOTES

1. WHERE THE REGULAR EXISTING SPEED LIMIT IS 50 km/h OR LESS, SPEED SIGNS ARE NOT REQUIRED. REDUCE POSTED SPEED IF HAZARD ASSESSMENT INDICATES SPEED REDUCTION REQUIRED.

752-3

TRAFFIC CONTROL MANUAL

2018

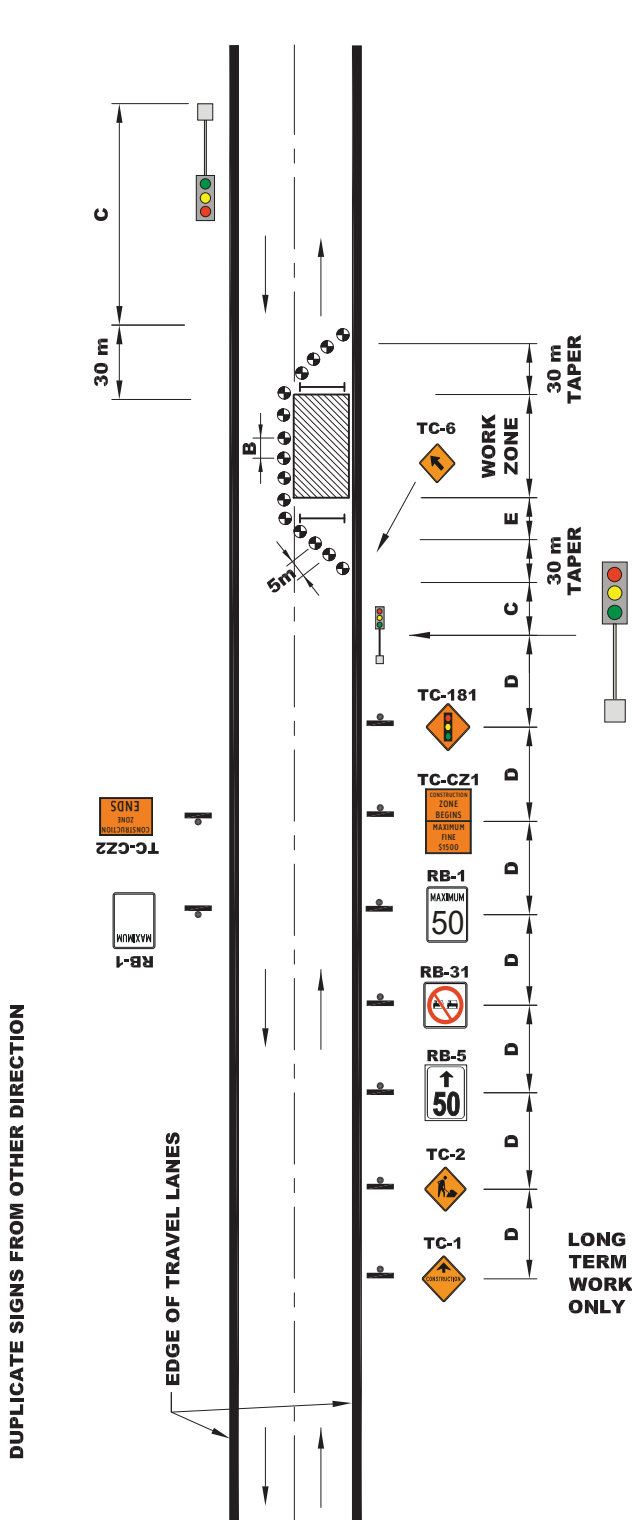

WORK ZONE DIMENSIONS FOR ONE LANE CLOSED FOR SHORT AND LONG TERM WORK USING PORTABLE TRAFFIC LIGHTS

DIMENSION (m)	NORMAL POSTED REGULATORY SPEED					
	50	60	70	80	90	100
A	30	40	60	90	110	180
B	5/8	5/12	5/15	5/15	5/18	5/20
C	30	40	40	50	50	50
D	50	50	75	100	100	150
E	35	50	50	75	75	75

POSTED SPEED IS EXISTING SPEED LIMIT (km/h)

A - TAPER LANE WHEN NO LANE CONTROL PRESENT

B - MAX. DELINEATOR SPACING IN TAPER/WORK ZONE

C - TRAFFIC CONTROL PERSON SETBACK (m)

D - DISTANCE BETWEEN CONSTRUCTION SIGNS

E - BUFFER AREA LENGTH BETWEEN TAPER AND WORK ZONE

NOTES

1. WHERE THE REGULAR EXISTING SPEED LIMIT IS 50 km/h OR LESS, SPEED SIGNS ARE NOT REQUIRED. REDUCE POSTED SPEED IF HAZARD ASSESSMENT INDICATES SPEED REDUCTION REQUIRED.

752-4

TRAFFIC CONTROL MANUAL 2018

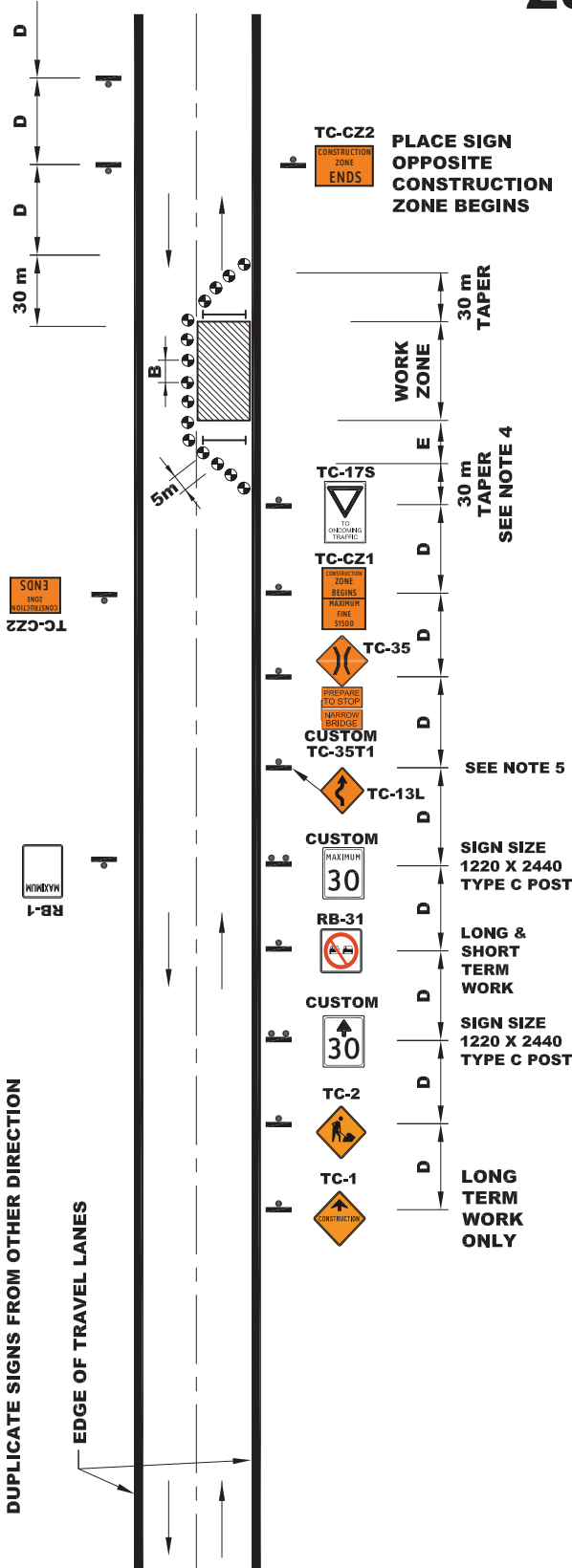

WORK ZONE DIMENSIONS FOR ONE LANE CLOSED VERY SHORT, SHORT & LONG TERM WORK USING YIELD TO ONCOMING TRAFFIC

DIMENSION (m)	NORMAL POSTED REGULATORY SPEED					
	50	60	70	80	90	100
A	30	40	60	90	110	180
B	5/8	5/12	5/15	5/15	5/18	5/20
C	30	40	40	50	50	50
D	50	50	75	100	100	150
E	35	50	50	75	75	75

- POSTED SPEED IS EXISTING SPEED LIMIT (km/h)**
- A** - TAPER LANE WHEN NO LANE CONTROL PRESENT
 - B** - MAX. DELINEATOR SPACING IN TAPER/WORK ZONE
 - C** - TRAFFIC CONTROL PERSON SETBACK (m)
 - D** - DISTANCE BETWEEN CONSTRUCTION SIGNS
 - E** - BUFFER AREA LENGTH BETWEEN TAPER AND WORK ZONE

NOTES

1. THIS LAYOUT WOULD TYPICALLY BE USED ON ROADWAYS WHERE ONE LANE IS CLOSED FOR LONG TERM WORK AND WHERE TRAFFIC VOLUMES ARE LOW. REQUIRED SIGHT DISTANCE FOR THE REGULAR POSTED SPEED LIMIT MUST BE AVAILABLE BETWEEN THE LAST SIGNS ON EACH APPROACH TO THE WORK AREA TO USE THIS LAYOUT. IF MINIMUM SIGHT DISTANCE IS NOT AVAILABLE USE LAYOUT 752-4 WITH PORTABLE TRAFFIC LIGHTS FOR LONG TERM WORK.
 2. WHERE THE DURATION OF THIS ACTIVITY IS DEFINED AS "LONG TERM WORK", ALL SIGNS TO BE INSTALLED AS PER SECTION "PERMANENTLY INSTALLED TEMPORARY CONDITION SIGN SUPPORTS", PAGE 4. THE BARRICADES MAY BE REPLACED BY FLASHING ARROW BOARDS.
 3. SIGN TC-17S SHALL ONLY BE PLACED IN ONE DIRECTION, AS DETERMINED BY THE DEPARTMENT'S RESIDENT ENGINEER, ON THE APPROACH WITH THE LEAST SIGHT DISTANCE.
 4. SIGN TC-13L AND TC-13R ARE ONLY REQUIRED IF THE ONE LANE SECTION FORMS A DIVERSION AROUND THE WORK ZONE.
 5. IF A TEMPORARY BRIDGE IS USED, BRIDGE END MARKERS WA-36AL AND WA-36AR SHALL BE INSTALLED AT THE BRIDGE ENDS.
- * CONTROL VEHICLE WITH "FAB" OR STAND-ALONE FAB REQUIRED WHEN CLOSING A LANE ON A BRIDGE STRUCTURE.

752-5

TRAFFIC CONTROL MANUAL 2018

NOTE: WHEN LEFT LANE IS CLOSED, CHANGE SIGN TC-6L TO TC-6R AND CHANGE TC-5R TO TC-5L
ALL SIGNS TO BE REPEATED ALONG THE SHOULDER OF THE LANE ADJACENT TO THE MEDIAN

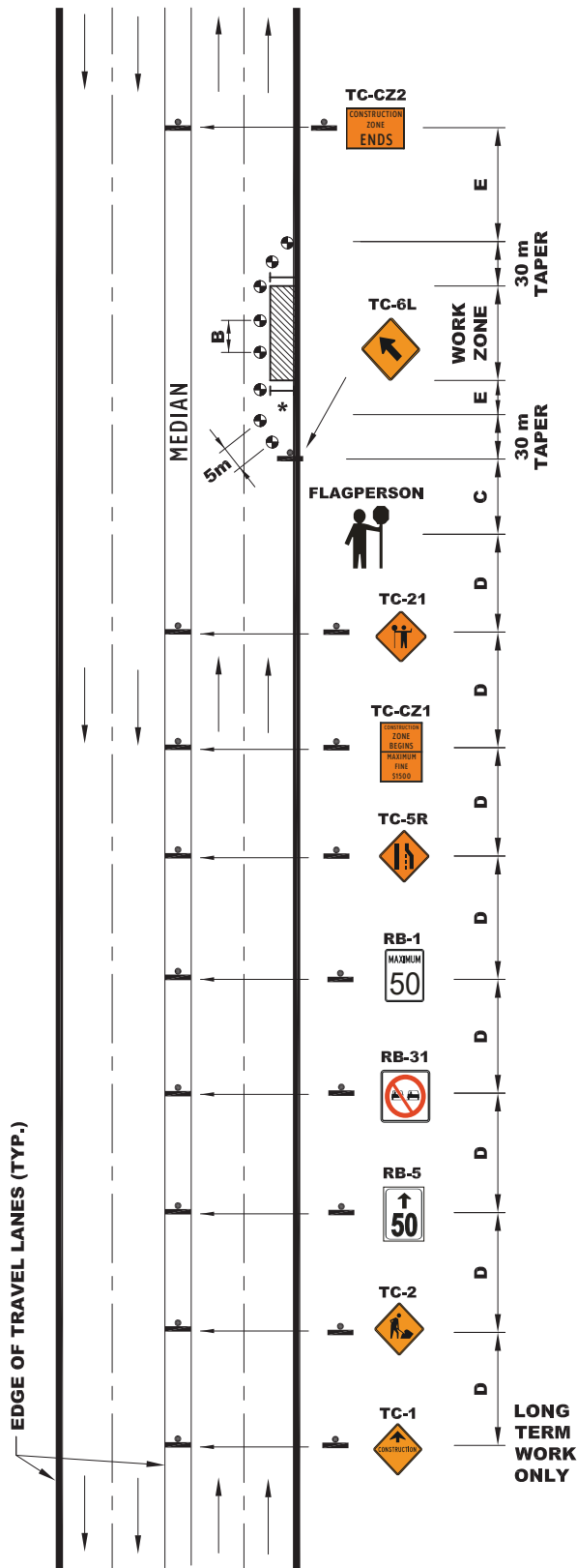

WORK ZONE DIMENSIONS FOR ONE LANE CLOSED WITH FLAGPERSONS DIVIDED HIGHWAY VERY SHORT & SHORT DURATION

DIMENSION (m)	NORMAL POSTED REGULATORY SPEED					
	50	60	70	80	90	100
A	30	40	60	90	110	180
B	5/8	5/12	5/15	5/15	5/18	5/20
C	30	40	40	50	50	50
D	50	50	75	100	100	150
E	35	50	50	75	75	75

POSTED SPEED IS EXISTING SPEED LIMIT (km/h)

A - TAPER LANE WHEN NO LANE CONTROL PRESENT

B - MAX. DELINEATOR SPACING IN TAPER/WORK ZONE

C - TRAFFIC CONTROL PERSON SETBACK (m)

D - DISTANCE BETWEEN CONSTRUCTION SIGNS

E - BUFFER AREA LENGTH BETWEEN TAPER AND WORK ZONE

NOTES

1. WHERE THE DURATION OF THIS ACTIVITY IS DEFINED AS "LONG TERM WORK", THE FLAGPERSON AND FLAGPERSON SIGN TC-21, SHALL BE REPLACED BY A FLASHING ARROW BOARD IN THE TAPER.

WHEN LONG DURATION IS REQUIRED USE TCM LAYOUT #'s 752-17 OR 752-15.

* CONTROL VEHICLE WITH "FAB" OR STAND-ALONE FAB REQUIRED WHEN CLOSING A LANE ON A BRIDGE STRUCTURE.

752-6

TRAFFIC CONTROL MANUAL

2018

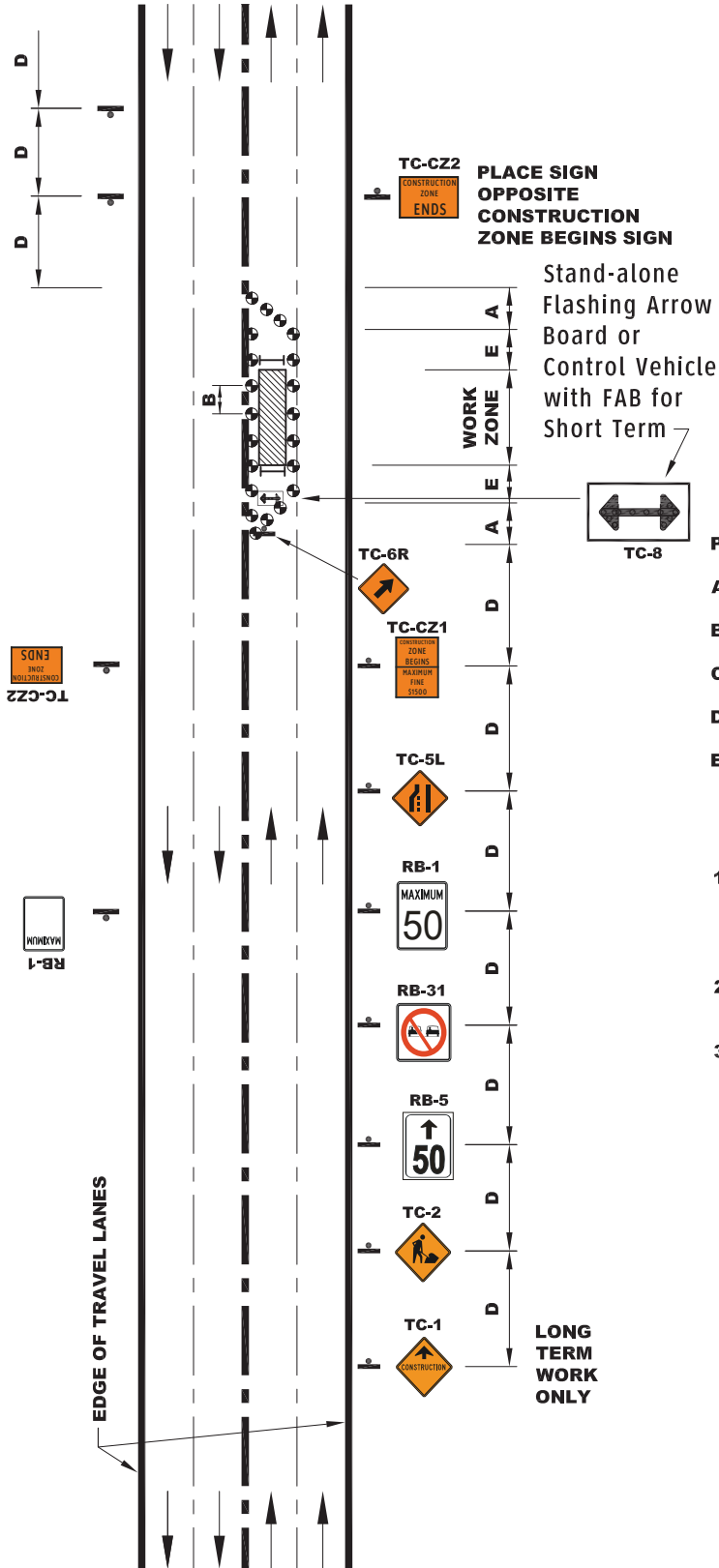

WORK ZONE DIMENSIONS FOR MULTI-LANE ROAD LEFT OR CENTER LANE CLOSED SHORT & LONG TERM WORK

DIMENSION (m)	NORMAL POSTED REGULATORY SPEED					
	50	60	70	80	90	100
A	30	40	60	90	110	180
B	5/8	8/12	10/15	10/15	12/18	15/20
C	30	40	40	50	50	50
D	50	50	75	100	100	150
E	35	50	50	75	75	75

POSTED SPEED IS EXISTING SPEED LIMIT (km/h)

A - TAPER LANE WHEN NO LANE CONTROL PRESENT

B - MAX. DELINEATOR SPACING IN TAPER/WORK ZONE

C - TRAFFIC CONTROL PERSON SETBACK (m)

D - DISTANCE BETWEEN CONSTRUCTION SIGNS

E - BUFFER AREA LENGTH BETWEEN TAPER AND WORK ZONE

NOTES

1. WHERE THE EXISTING SPEED LIMIT IS 50 km/h OR LESS, SPEED SIGNS ARE NOT REQUIRED. REDUCE POSTED SPEED IF HAZARD ASSESSMENT INDICATES SPEED REDUCTION REQUIRED.
2. CONES OR DELINEATOR POSTS MAY BE SUBSTITUTED WITH DRUMS.
3. SIGN OPPOSITE APPROACH IN SAME MANNER EXCEPT ELIMINATE SIGN TC-5L.

752-7

TRAFFIC CONTROL MANUAL 2018

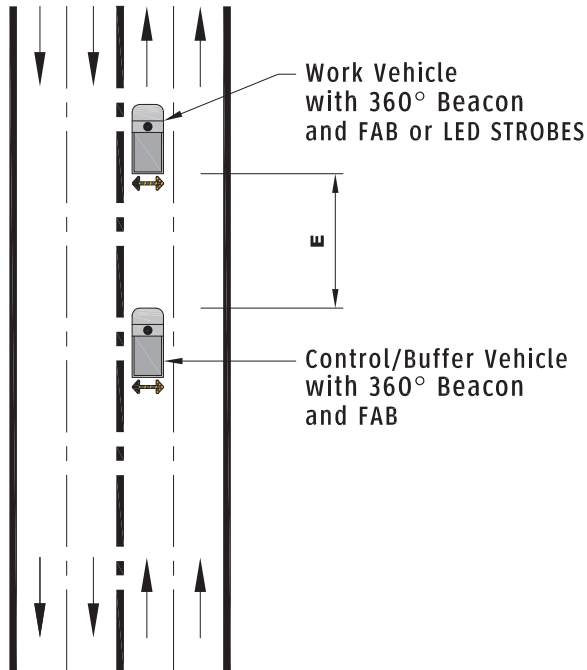

OR

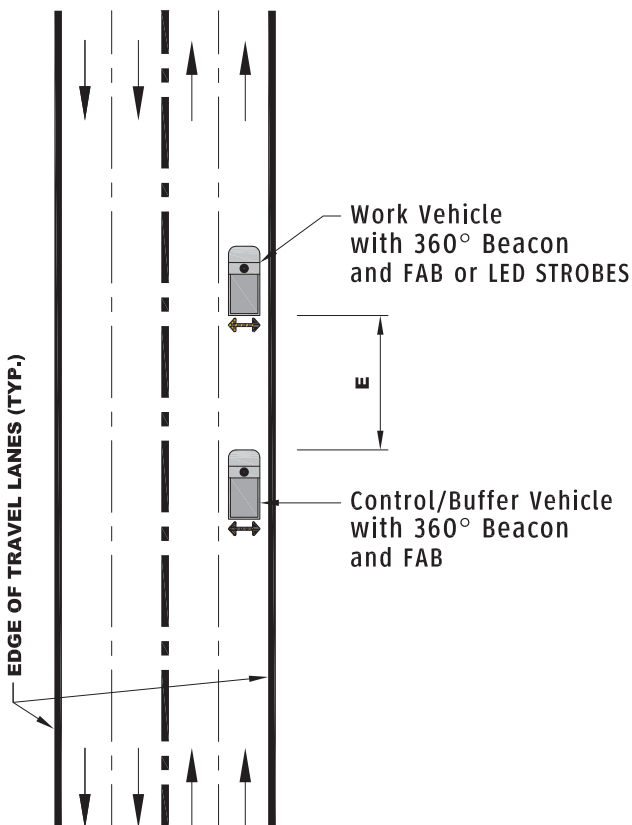

WORK ZONE DIMENSIONS FOR LEFT OR RIGHT LANE CLOSED UNDIVIDED HIGHWAY MOBILE OPERATIONS

DIMENSION (m)	NORMAL POSTED REGULATORY SPEED					
	50	60	70	80	90	100
A	30	40	60	90	110	180
B	5/8	8/12	10/15	10/15	12/18	15/20
C	30	40	40	50	50	50
D	50	50	75	100	100	150
E	35	50	50	75	75	75

POSTED SPEED IS EXISTING SPEED LIMIT (km/h)

A - TAPER LANE WHEN NO LANE CONTROL PRESENT

B - MAX. DELINEATOR SPACING IN TAPER/WORK ZONE

C - TRAFFIC CONTROL PERSON SETBACK (m)

D - DISTANCE BETWEEN CONSTRUCTION SIGNS

E - BUFFER AREA LENGTH BETWEEN TAPER AND WORK ZONE

NOTES

1. CONTROL/BUFFER VEHICLE IS NOT REQUIRED FOR REGULAR POSTED SPEEDS OF 60 km/h OR LOWER.

2. FLASHING ARROW BOARD (FAB) AND 360° ROTATING TOP MOUNTED BEACON SHALL BE ENGAGED TO REDIRECT DOWNSTREAM TRAFFIC AWAY FROM WORK AND CONTROL/BUFFER VEHICLES.

752-8

TRAFFIC CONTROL MANUAL 2018

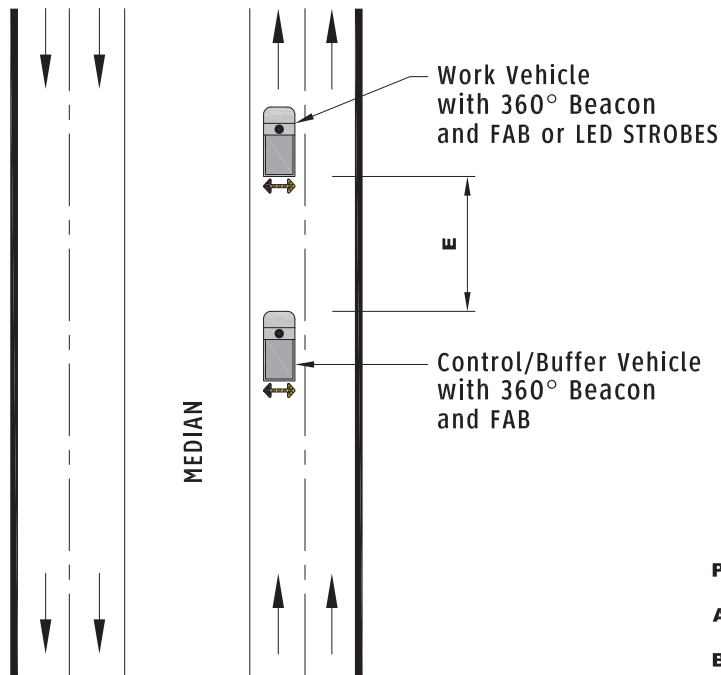

OR

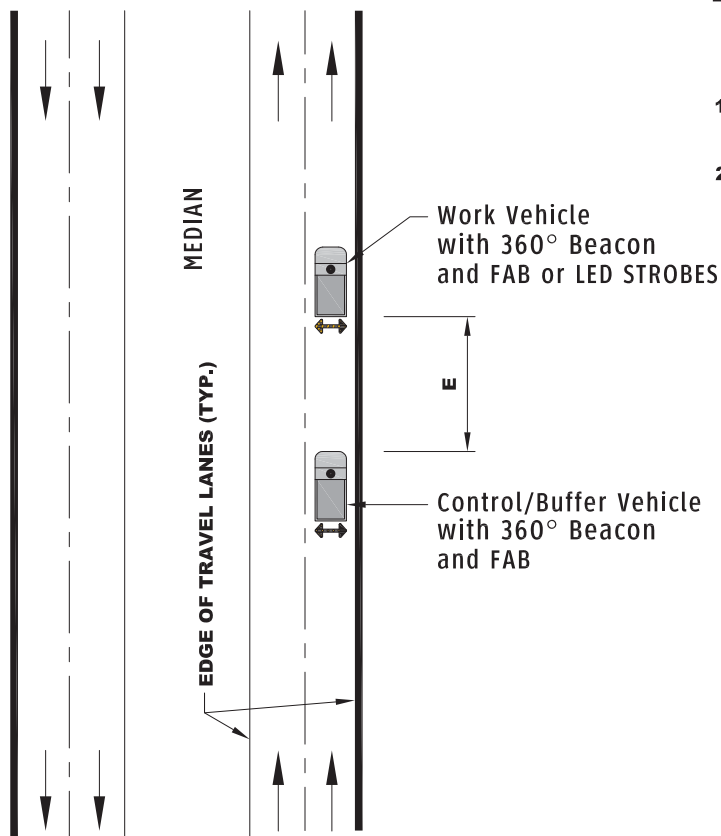

WORK ZONE DIMENSIONS FOR LEFT OR RIGHT LANE CLOSED DIVIDED HIGHWAY MOBILE OPERATIONS

DIMENSION (m)	NORMAL POSTED REGULATORY SPEED					
	50	60	70	80	90	100
A	30	40	60	90	110	180
B	5/8	8/12	10/15	10/15	12/18	15/20
C	30	40	40	50	50	50
D	50	50	75	100	100	150
E	35	50	50	75	75	75

POSTED SPEED IS EXISTING SPEED LIMIT (km/h)

A - TAPER LANE WHEN NO LANE CONTROL PRESENT

B - MAX. DELINEATOR SPACING IN TAPER/WORK ZONE

C - TRAFFIC CONTROL PERSON SETBACK (m)

D - DISTANCE BETWEEN CONSTRUCTION SIGNS

E - BUFFER AREA LENGTH BETWEEN TAPER AND WORK ZONE

NOTES

- CONTROL/BUFFER VEHICLE IS NOT REQUIRED FOR REGULAR POSTED SPEEDS OF 60 km/h OR LOWER.
- FLASHING ARROW BOARD (FAB) AND 360° ROTATING TOP MOUNTED BEACON SHALL BE ENGAGED TO REDIRECT DOWNSTREAM TRAFFIC AWAY FROM WORK AND CONTROL/BUFFER VEHICLES.

752-9

TRAFFIC CONTROL MANUAL 2018

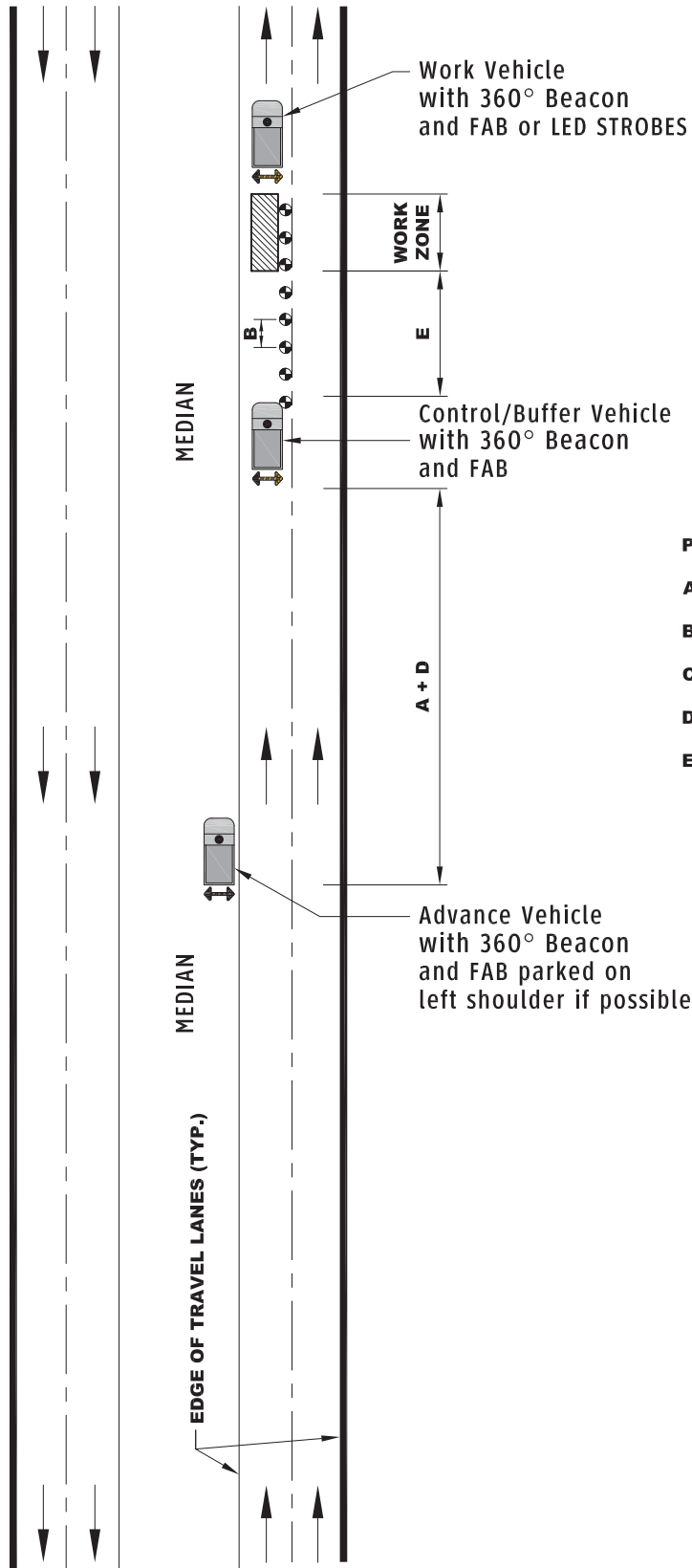

WORK ZONE DIMENSIONS FOR LEFT LANE CLOSED MULTI-LANE DIVIDED HIGHWAY VERY SHORT DURATION

DIMENSION (m)	NORMAL POSTED REGULATORY SPEED					
	50	60	70	80	90	100
A	30	40	60	90	110	180
B	5/8	8/12	10/15	10/15	12/18	15/20
C	30	40	40	50	50	50
D	50	50	75	100	100	150
E	35	50	50	75	75	75

POSTED SPEED IS EXISTING SPEED LIMIT (km/h)

A - TAPER LANE WHEN NO LANE CONTROL PRESENT

B - MAX. DELINEATOR SPACING IN TAPER/WORK ZONE

C - TRAFFIC CONTROL PERSON SETBACK (m)

D - DISTANCE BETWEEN CONSTRUCTION SIGNS

E - BUFFER AREA LENGTH BETWEEN TAPER AND WORK ZONE

NOTES

- ADVANCE VEHICLE IS NOT REQUIRED FOR REGULAR POSTED SPEEDS OF 60 km/h OR LOWER.
- FLASHING ARROW BOARD (FAB) AND 360° ROTATING TOP MOUNTED BEACON SHALL BE ENGAGED TO REDIRECT DOWNSTREAM TRAFFIC AWAY FROM WORK AND CONTROL/BUFFER VEHICLES.

752-10

TRAFFIC CONTROL MANUAL

2018

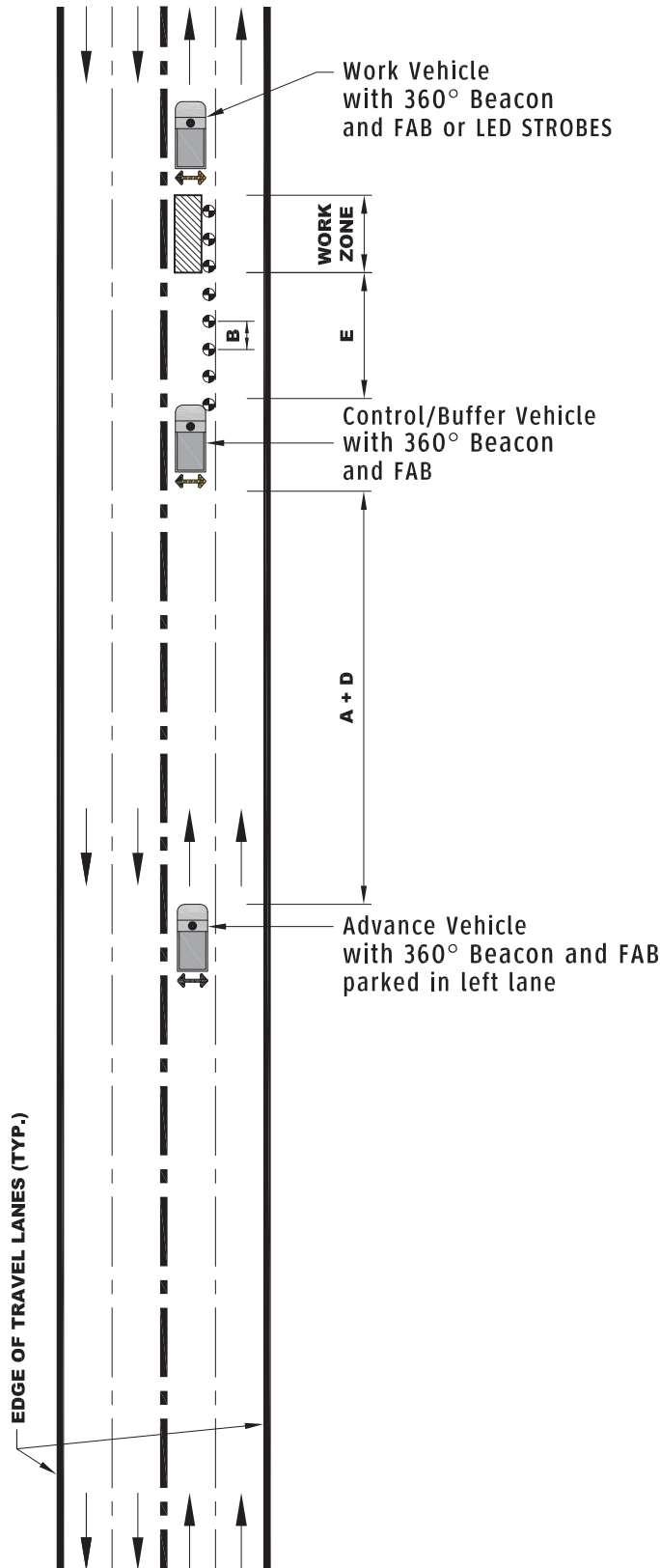

WORK ZONE DIMENSIONS FOR LEFT LANE CLOSED UNDIVIDED HIGHWAY VERY SHORT DURATION

DIMENSION (m)	NORMAL POSTED REGULATORY SPEED					
	50	60	70	80	90	100
A	30	40	60	90	110	180
B	5/8	8/12	10/15	10/15	12/18	15/20
C	30	40	40	50	50	50
D	50	50	75	100	100	150
E	35	50	50	75	75	75

POSTED SPEED IS EXISTING SPEED LIMIT (km/h)

A - TAPER LANE WHEN NO LANE CONTROL PRESENT

B - MAX. DELINEATOR SPACING IN TAPER/WORK ZONE

C - TRAFFIC CONTROL PERSON SETBACK (m)

D - DISTANCE BETWEEN CONSTRUCTION SIGNS

E - BUFFER AREA LENGTH BETWEEN TAPER AND WORK ZONE

NOTES

- ADVANCE VEHICLE IS NOT REQUIRED FOR REGULAR POSTED SPEEDS OF 60 km/h OR LOWER.
- FLASHING ARROW BOARD (FAB) AND 360° ROTATING TOP MOUNTED BEACON SHALL BE ENGAGED TO REDIRECT DOWNSTREAM TRAFFIC AWAY FROM WORK AND CONTROL/BUFFER VEHICLES.

752-11

TRAFFIC CONTROL MANUAL

2018

NOTE: ALL SIGNS TO BE REPEATED ALONG THE SHOULDER OF THE LANE ADJACENT TO THE MEDIAN

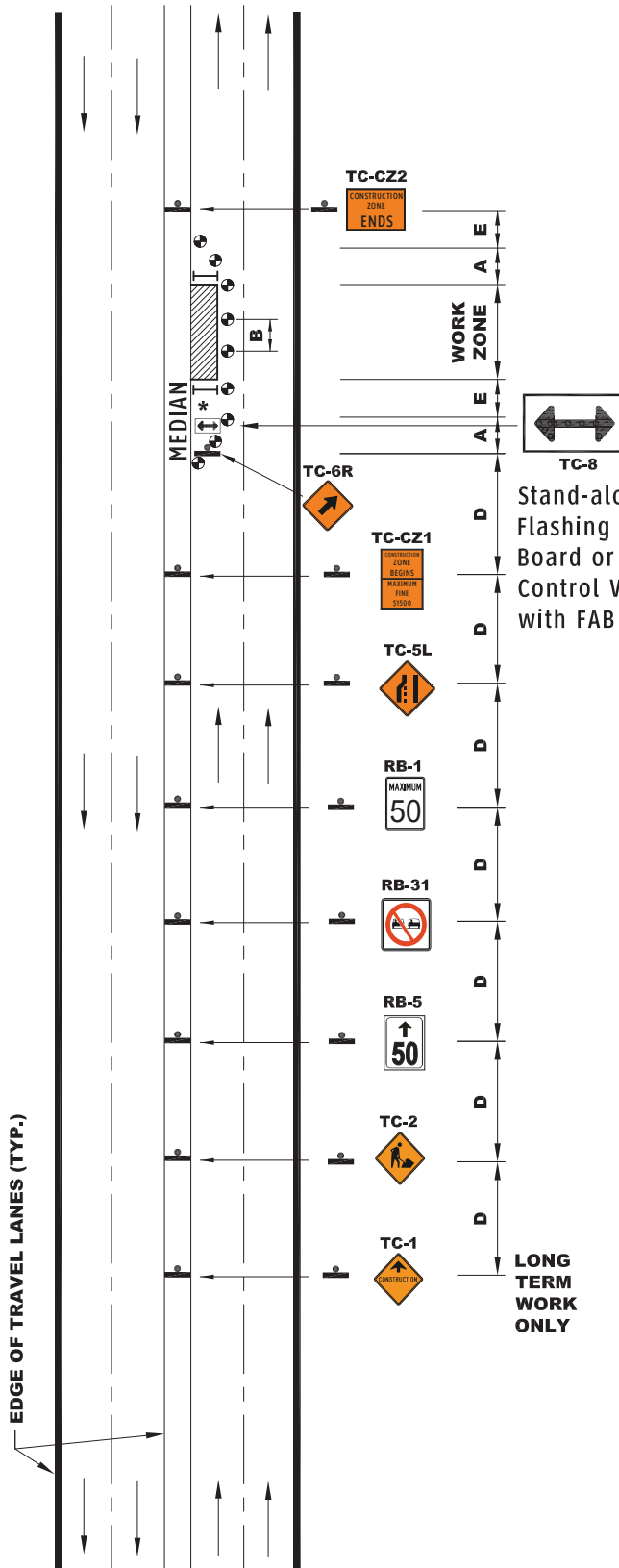

WORK ZONE DIMENSIONS FOR LEFT LANE CLOSED DIVIDED HIGHWAY SHORT DURATION

DIMENSION (m)	NORMAL POSTED REGULATORY SPEED					
	50	60	70	80	90	100
A	30	40	60	90	110	180
B	5/8	8/12	10/15	10/15	12/18	15/20
C	30	40	40	50	50	50
D	50	50	75	100	100	150
E	35	50	50	75	75	75

Stand-alone Flashing Arrow Board or Control Vehicle with FAB

POSTED SPEED IS EXISTING SPEED LIMIT (km/h)

A - TAPER LANE WHEN NO LANE CONTROL PRESENT

B - MAX. DELINEATOR SPACING IN TAPER/WORK ZONE

C - TRAFFIC CONTROL PERSON SETBACK (m)

D - DISTANCE BETWEEN CONSTRUCTION SIGNS

E - BUFFER AREA LENGTH BETWEEN TAPER AND WORK ZONE

NOTES

1. WHERE THE DURATION OF THIS ACTIVITY IS DEFINED AS "LONG TERM WORK", AND THE REGULAR POSTED SPEED LIMIT IS GREATER THAN 60 km/h PROVIDE AN ADVANCE CONSTRUCTION AHEAD 1 km AND AN ADDITIONAL LEFT LANE ENDS SIGN TC-5L.
2. WHERE THE REGULAR SPEED LIMIT IS 50 km/h OR LESS, SPEED SIGNS ARE NOT REQUIRED. REDUCE POSTED SPEED IF HAZARD ASSESSMENT INDICATES SPEED REDUCTION REQUIRED.

* CONTROL VEHICLE WITH "FAB" OR STAND-ALONE FAB REQUIRED WHEN CLOSING A LANE ON A BRIDGE STRUCTURE.

LONG TERM WORK ONLY

752-12

TRAFFIC CONTROL MANUAL

2018

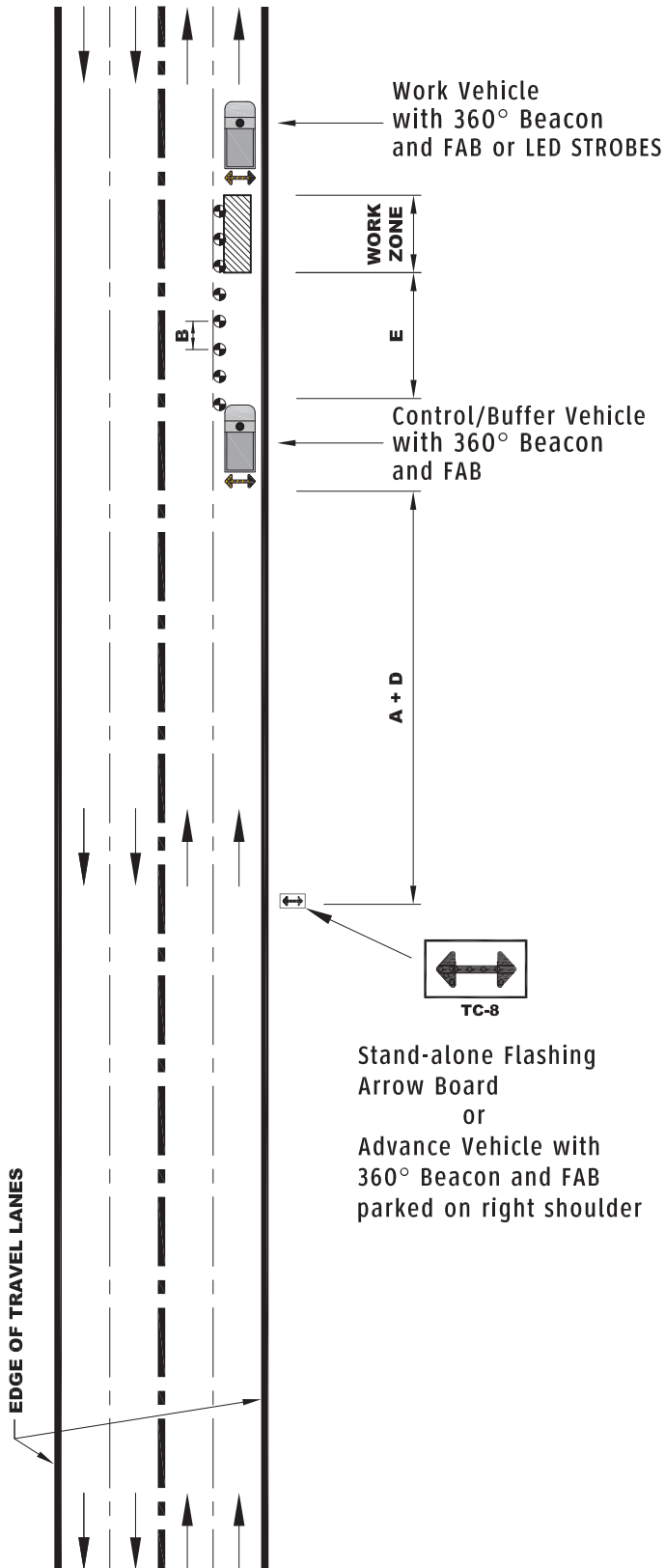

WORK ZONE DIMENSIONS FOR RIGHT LANE CLOSED UNDIVIDED HIGHWAY VERY SHORT DURATION

DIMENSION (m)	NORMAL POSTED REGULATORY SPEED					
	50	60	70	80	90	100
A	30	40	60	90	110	180
B	5/8	8/12	10/15	10/15	12/18	15/20
C	30	40	40	50	50	50
D	50	50	75	100	100	150
E	35	50	50	75	75	75

POSTED SPEED IS EXISTING SPEED LIMIT (km/h)

A - TAPER LANE WHEN NO LANE CONTROL PRESENT

B - MAX. DELINEATOR SPACING IN TAPER/WORK ZONE

C - TRAFFIC CONTROL PERSON SETBACK (m)

D - DISTANCE BETWEEN CONSTRUCTION SIGNS

E - BUFFER AREA LENGTH BETWEEN TAPER AND WORK ZONE

NOTES

- ADVANCE VEHICLE OR TC-8 STAND-ALONE FLASHING ARROW BOARD IS NOT REQUIRED FOR REGULAR POSTED SPEEDS OF 60 km/h OR LOWER.
- FLASHING ARROW BOARD (FAB) AND 360° ROTATING TOP MOUNTED BEACON SHALL BE ENGAGED TO REDIRECT DOWNSTREAM TRAFFIC AWAY FROM WORK AND CONTROL/BUFFER VEHICLES.

752-13

TRAFFIC CONTROL MANUAL

2018

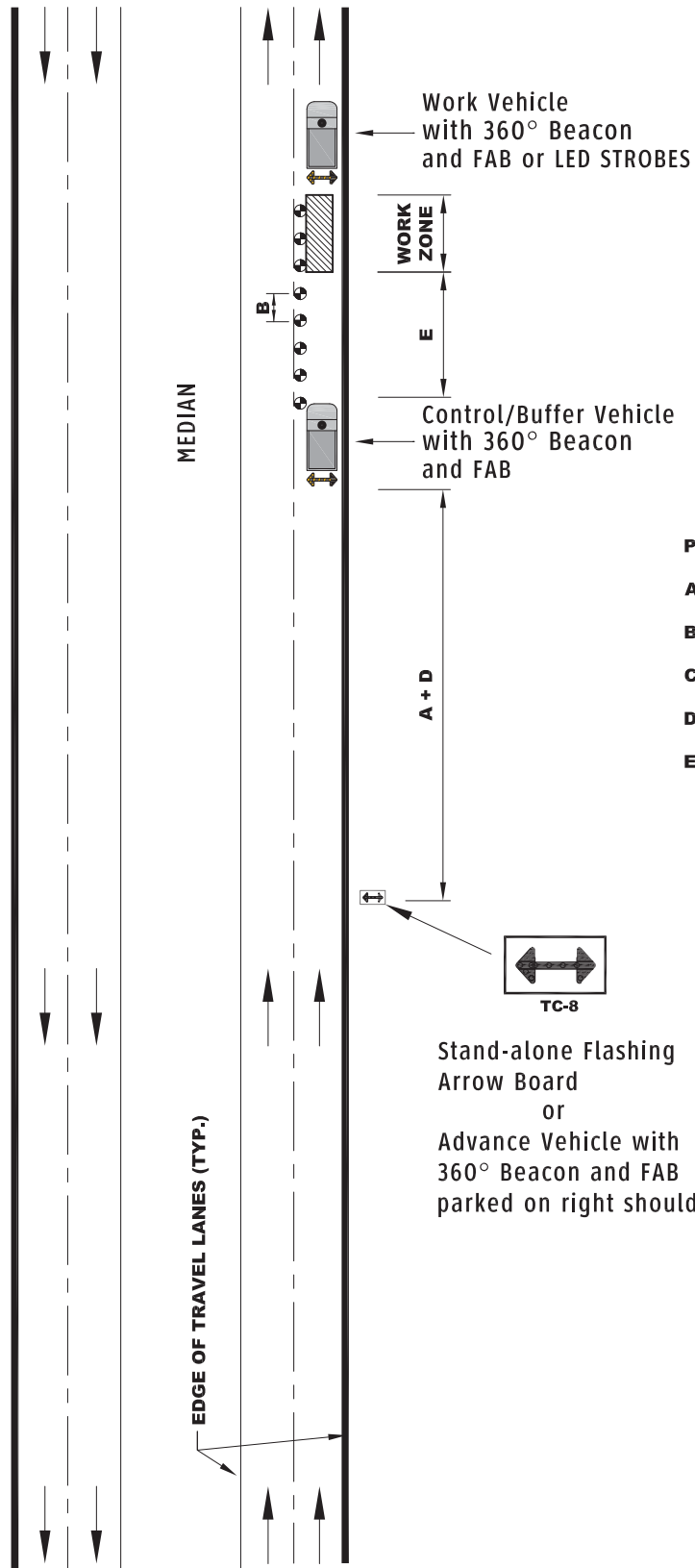

WORK ZONE DIMENSIONS FOR RIGHT LANE CLOSED MULTI-LANE DIVIDED HIGHWAY VERY SHORT DURATION

DIMENSION (m)	NORMAL POSTED REGULATORY SPEED					
	50	60	70	80	90	100
A	30	40	60	90	110	180
B	5/8	8/12	10/15	10/15	12/18	15/20
C	30	40	40	50	50	50
D	50	50	75	100	100	150
E	35	50	50	75	75	75

POSTED SPEED IS EXISTING SPEED LIMIT (km/h)

A - TAPER LANE WHEN NO LANE CONTROL PRESENT

B - MAX. DELINEATOR SPACING IN TAPER/WORK ZONE

C - TRAFFIC CONTROL PERSON SETBACK (m)

D - DISTANCE BETWEEN CONSTRUCTION SIGNS

E - BUFFER AREA LENGTH BETWEEN TAPER AND WORK ZONE

NOTES

- ADVANCE VEHICLE OR TC-8 STAND-ALONE FLASHING ARROW BOARD IS NOT REQUIRED FOR REGULAR POSTED SPEEDS OF 60 km/h OR LOWER.
- FLASHING ARROW BOARD (FAB) AND 360° ROTATING TOP MOUNTED BEACON SHALL BE ENGAGED TO REDIRECT DOWNSTREAM TRAFFIC AWAY FROM WORK AND CONTROL/BUFFER VEHICLES.

752-14

TRAFFIC CONTROL MANUAL 2018

NOTE: ALL SIGNS TO BE REPEATED ALONG THE SHOULDER OF THE LANE ADJACENT TO THE MEDIAN

EDGE OF TRAVEL LANES (TYP.)

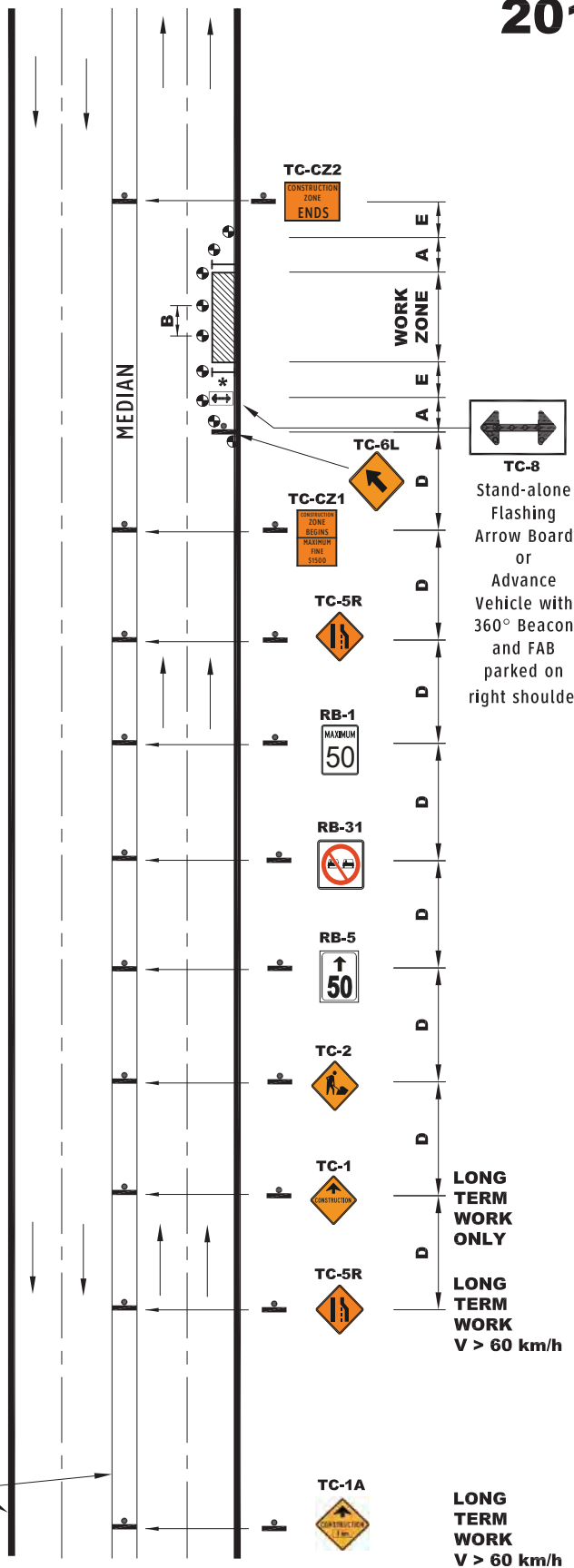

WORK ZONE DIMENSIONS FOR RIGHT LANE CLOSED MULTI-LANE ROAD - DIVIDED HIGHWAY SHORT AND LONG DURATION

DIMENSION (m)	NORMAL POSTED REGULATORY SPEED					
	50	60	70	80	90	100
A	30	40	60	90	110	180
B	5/8	8/12	10/15	10/15	12/18	15/20
C	30	40	40	50	50	50
D	50	50	75	100	100	150
E	35	50	50	75	75	75

POSTED SPEED IS EXISTING SPEED LIMIT (km/h)

A - TAPER LANE WHEN NO LANE CONTROL PRESENT

B - MAX. DELINEATOR SPACING IN TAPER/WORK ZONE

C - TRAFFIC CONTROL PERSON SETBACK (m)

D - DISTANCE BETWEEN CONSTRUCTION SIGNS

E - BUFFER AREA LENGTH BETWEEN TAPER AND WORK ZONE

NOTES

- WHERE THE DURATION OF THIS ACTIVITY IS DEFINED AS "LONG TERM WORK", AND THE REGULAR POSTED SPEED LIMIT IS GREATER THAN 60 km/h PROVIDE AN ADVANCE CONSTRUCTION AHEAD 1 km AND AN ADDITIONAL LEFT LANE ENDS SIGN TC-5R.
- WHERE THE REGULAR EXISTING SPEED LIMIT IS 50 km/h OR LESS, SPEED SIGNS ARE NOT REQUIRED. REDUCE POSTED SPEED IF HAZARD ASSESSMENT INDICATES SPEED REDUCTION REQUIRED.

* CONTROL VEHICLE WITH "FAB" REQUIRED WHEN CLOSING A LANE ON A BRIDGE STRUCTURE.

752-15

TRAFFIC CONTROL MANUAL

2018

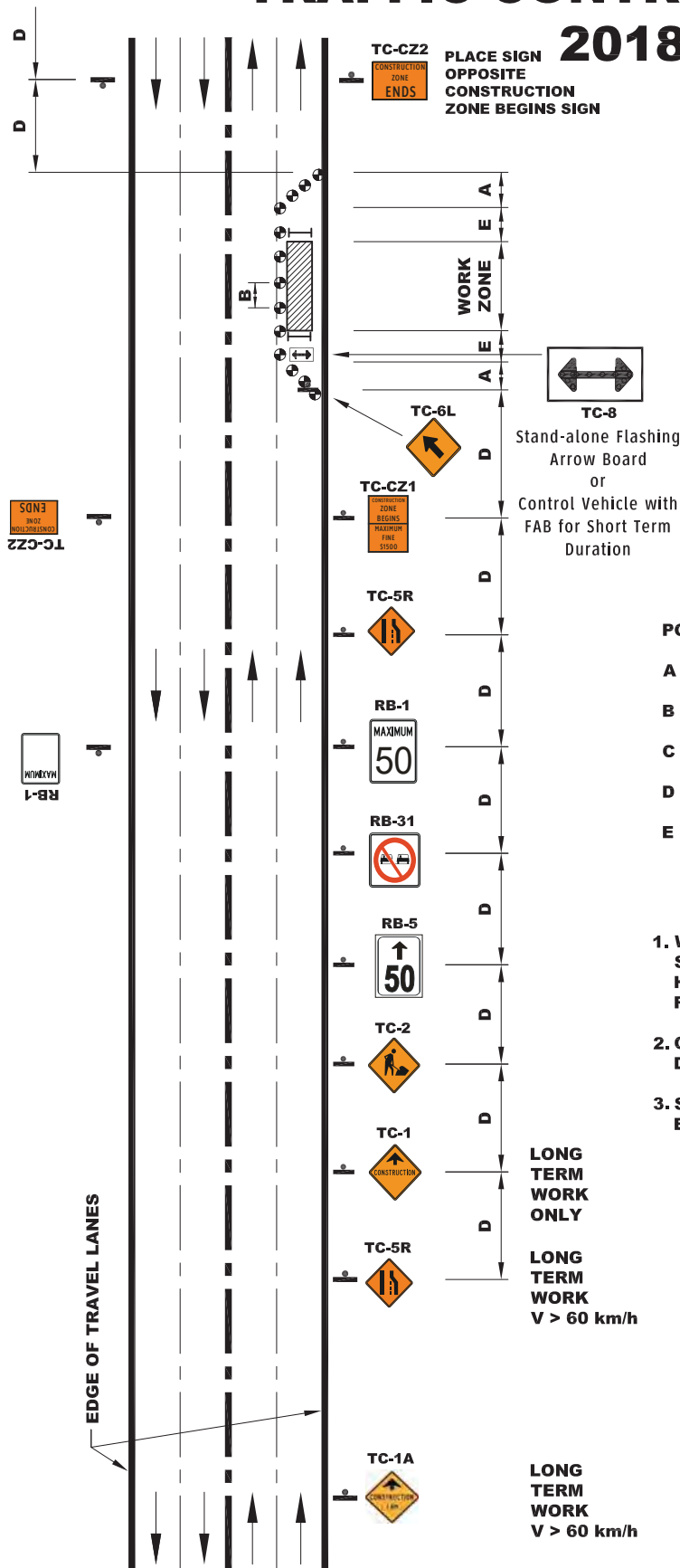

WORK ZONE DIMENSIONS FOR MULTI-LANE ROAD UNDIVIDED HIGHWAY RIGHT LANE CLOSED SHORT & LONG TERM WORK

DIMENSION (m)	NORMAL POSTED REGULATORY SPEED					
	50	60	70	80	90	100
A	30	40	60	90	110	180
B	5/8	8/12	10/15	10/15	12/18	15/20
C	30	40	40	50	50	50
D	50	50	75	100	100	150
E	35	50	50	75	75	75

POSTED SPEED IS EXISTING SPEED LIMIT (km/h)

A - TAPER LANE WHEN NO LANE CONTROL PRESENT

B - MAX. DELINEATOR SPACING IN TAPER/WORK ZONE

C - TRAFFIC CONTROL PERSON SETBACK (m)

D - DISTANCE BETWEEN CONSTRUCTION SIGNS

E - BUFFER AREA LENGTH BETWEEN TAPER AND WORK ZONE

NOTES

- WHERE THE EXISTING SPEED LIMIT IS 50 km/h OR LESS, SPEED SIGNS ARE NOT REQUIRED. REDUCE POSTED SPEED IF HAZARD ASSESSMENT INDICATES SPEED REDUCTION REQUIRED.
- CONES OR DELINEATOR POSTS MAY BE SUBSTITUTED WITH DRUMS.
- SIGN OPPOSITE APPROACH IN SAME MANNER EXCEPT ELIMINATE SIGN TC-5R.

LONG TERM WORK ONLY

LONG TERM WORK
V > 60 km/h

LONG TERM WORK
V > 60 km/h

752-16

TRAFFIC CONTROL MANUAL

2018

NOTE: ALL SIGNS TO BE REPEATED ALONG THE SHOULDER OF THE LANE ADJACENT TO THE MEDIAN

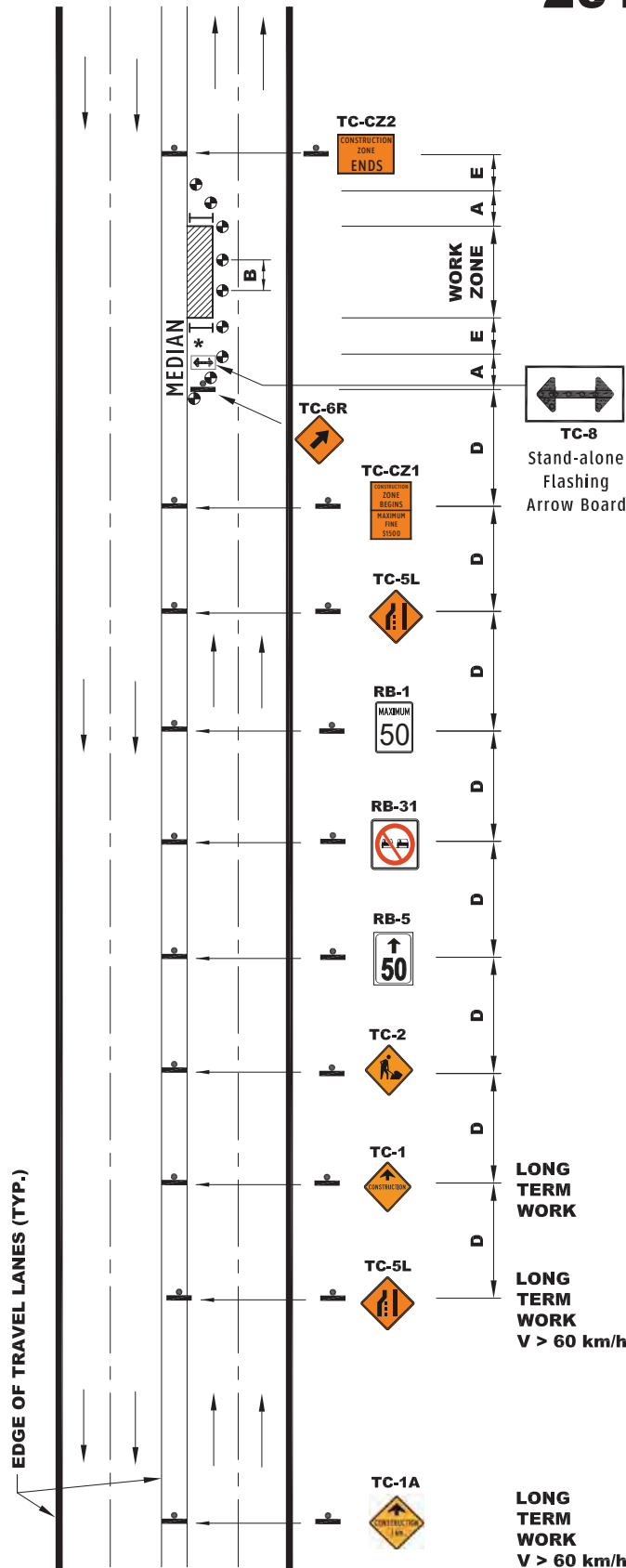

WORK ZONE DIMENSIONS FOR LEFT LANE CLOSED DIVIDED HIGHWAY LONG DURATION

DIMENSION (m)	NORMAL POSTED REGULATORY SPEED					
	50	60	70	80	90	100
A	30	40	60	90	110	180
B	5/8	8/12	10/15	10/15	12/18	15/20
C	30	40	40	50	50	50
D	50	50	75	100	100	150
E	35	50	50	75	75	75

POSTED SPEED IS EXISTING SPEED LIMIT (km/h)

A - TAPER LANE WHEN NO LANE CONTROL PRESENT

B - MAX. DELINEATOR SPACING IN TAPER/WORK ZONE

C - TRAFFIC CONTROL PERSON SETBACK (m)

D - DISTANCE BETWEEN CONSTRUCTION SIGNS

E - BUFFER AREA LENGTH BETWEEN TAPER AND WORK ZONE

NOTES

1. WHERE THE DURATION OF THIS ACTIVITY IS DEFINED AS "LONG TERM WORK", AND THE REGULAR POSTED SPEED LIMIT IS GREATER THAN 60 km/h PROVIDE AN ADVANCE CONSTRUCTION AHEAD 1 km AND AN ADDITIONAL LEFT LANE ENDS SIGN TC-5L.

2. WHERE THE REGULAR EXISTING SPEED LIMIT IS 50 km/h OR LESS, SPEED SIGNS ARE NOT REQUIRED. REDUCE POSTED SPEED IF HAZARD ASSESSMENT INDICATES SPEED REDUCTION REQUIRED.

* CONTROL VEHICLE WITH "FAB" REQUIRED WHEN CLOSING A LANE ON A BRIDGE STRUCTURE.

752-17

TRAFFIC CONTROL MANUAL

2018

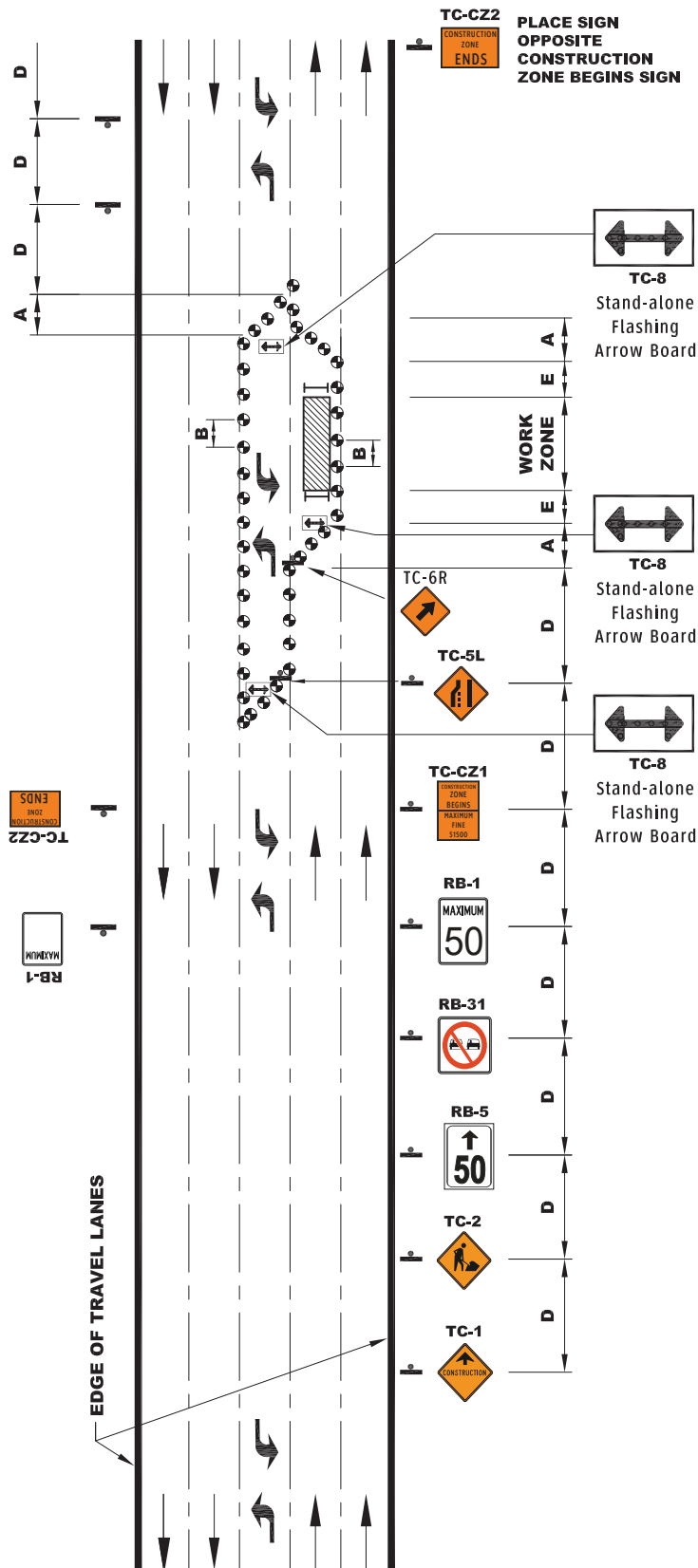

WORK ZONE DIMENSIONS FOR FIVE LANE ROAD - LEFT LANE CLOSED VERY SHORT, SHORT AND LONG DURATION - UNDIVIDED HIGHWAY

DIMENSION (m)	NORMAL POSTED REGULATORY SPEED					
	50	60	70	80	90	100
A	30	40	60	90	110	180
B	5/8	8/12	10/15	10/15	12/18	15/20
C	30	40	40	50	50	50
D	50	50	75	100	100	150
E	35	50	50	75	75	75

POSTED SPEED IS EXISTING SPEED LIMIT (km/h)

A - TAPER LANE WHEN NO LANE CONTROL PRESENT

B - MAX. DELINEATOR SPACING IN TAPER/WORK ZONE

C - TRAFFIC CONTROL PERSON SETBACK (m)

D - DISTANCE BETWEEN CONSTRUCTION SIGNS

E - BUFFER AREA LENGTH BETWEEN TAPER AND WORK ZONE

NOTES

1. WHERE THE DURATION OF THIS ACTIVITY IS DEFINED AS "LONG TERM WORK", AND THE REGULAR POSTED SPEED LIMIT IS GREATER THAN 60 km/h PROVIDE AN ADVANCE CONSTRUCTION AHEAD 1 km AND AN ADDITIONAL LEFT LANE ENDS SIGN TC-5L.
2. WHERE THE REGULAR EXISTING SPEED LIMIT IS 50 km/h OR LESS, SPEED SIGNS ARE NOT REQUIRED. REDUCE POSTED SPEED IF HAZARD ASSESSMENT INDICATES SPEED REDUCTION REQUIRED.
3. CONES OR DELINEATION POSTS MAY BE SUBSTITUTED WITH DRUMS.
4. SIGN OPPOSITE APPROACH IN SAME MANNER EXCEPT ELIMINATE SIGN TC-5L.
5. STAND-ALONE FAB MAY BE SUBSTITUTED WITH A CONTROL VEHICLE WITH A FAB FOR VERY SHORT AND SHORT DURATION

752-18

TRAFFIC CONTROL MANUAL

2018

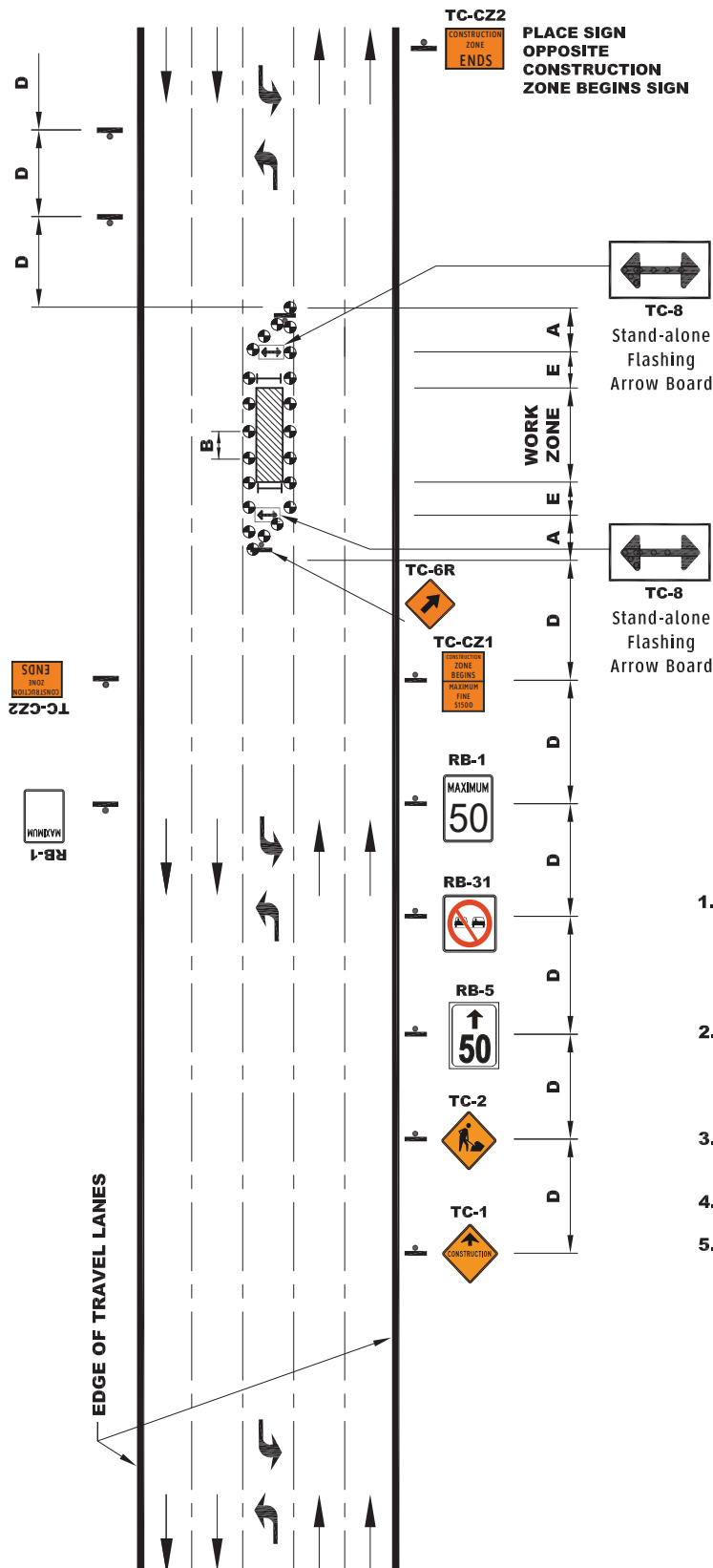

WORK ZONE DIMENSIONS FOR TWO-WAY LEFT-TURN LANE CLOSED VERY SHORT, SHORT AND LONG DURATION - UNDIVIDED HIGHWAY

DIMENSION (m)	NORMAL POSTED REGULATORY SPEED					
	50	60	70	80	90	100
A	30	40	60	90	110	180
B	5/8	8/12	10/15	10/15	12/18	15/20
C	30	40	40	50	50	50
D	50	50	75	100	100	150
E	35	50	50	75	75	75

POSTED SPEED IS EXISTING SPEED LIMIT (km/h)

- A - TAPER LANE WHEN NO LANE CONTROL PRESENT
- B - MAX. DELINEATOR SPACING IN TAPER/WORK ZONE
- C - TRAFFIC CONTROL PERSON SETBACK (m)
- D - DISTANCE BETWEEN CONSTRUCTION SIGNS
- E - BUFFER AREA LENGTH BETWEEN TAPER AND WORK ZONE

NOTES

1. WHERE THE DURATION OF THIS ACTIVITY IS DEFINED AS "LONG TERM WORK", AND THE REGULAR POSTED SPEED LIMIT IS GREATER THAN 60 km/h PROVIDE AN ADVANCE CONSTRUCTION AHEAD 1 km AND A LEFT LANE ENDS SIGN TC-5L.
2. WHERE THE REGULAR EXISTING SPEED LIMIT IS 50 km/h OR LESS, SPEED SIGNS ARE NOT REQUIRED. REDUCE POSTED SPEED IF HAZARD ASSESSMENT INDICATES SPEED REDUCTION REQUIRED.
3. CONES OR DELINEATION POSTS MAY BE SUBSTITUTED WITH DRUMS.
4. SIGN OPPOSITE APPROACH IN SAME MANNER.
5. TC-8 MAY BE REPLACED WITH A CONTROL VEHICLE WITH FAB FOR VERY SHORT AND SHORT DURATION

752-19

TRAFFIC CONTROL MANUAL 2018

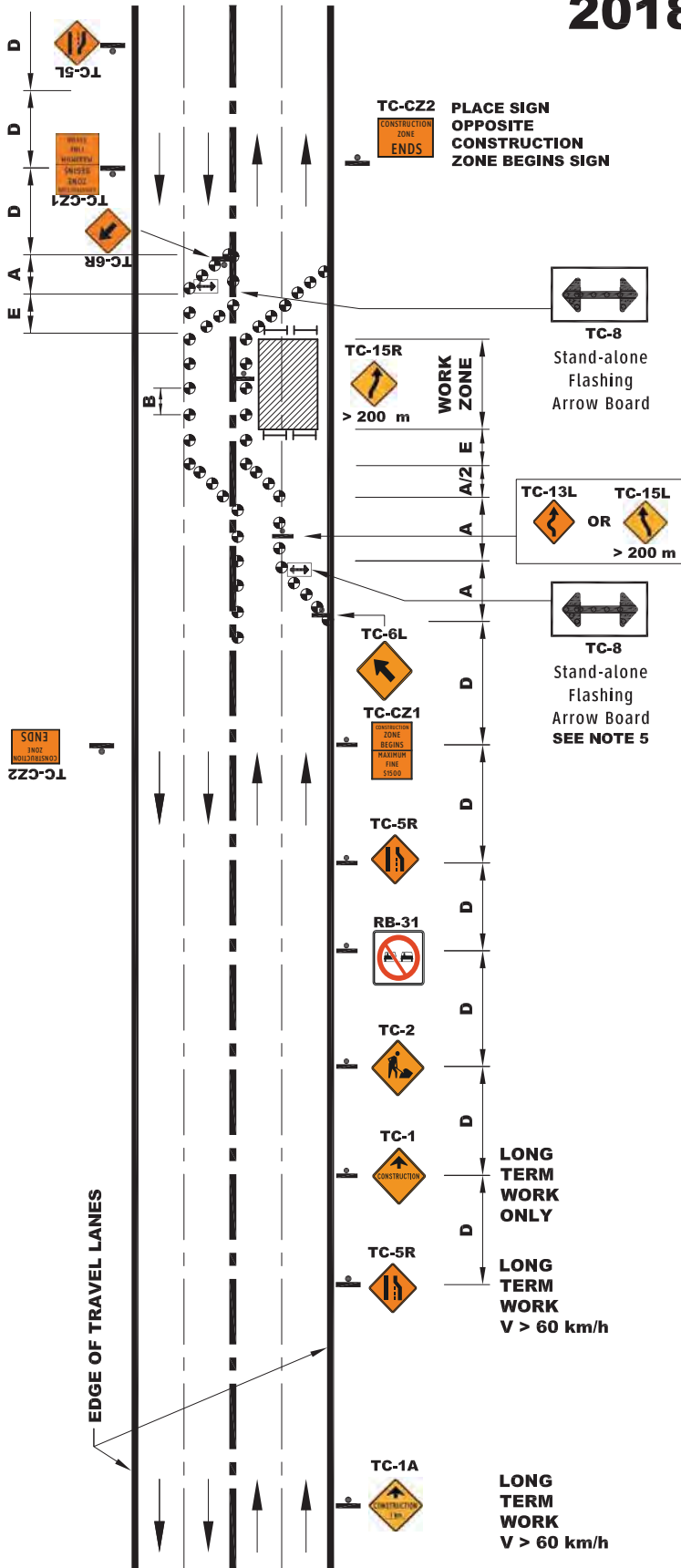

WORK ZONE DIMENSIONS FOR FOUR LANE ROAD TWO RIGHT LANES CLOSED VERY SHORT, SHORT & LONG TERM WORK

DIMENSION (m)	NORMAL POSTED REGULATORY SPEED					
	50	60	70	80	90	100
A	30	40	60	90	110	180
B	5/8	8/12	10/15	10/15	12/18	15/20
C	30	40	40	50	50	50
D	50	50	75	100	100	150
E	35	50	50	75	75	75

POSTED SPEED IS EXISTING SPEED LIMIT (km/h)

- A - TAPER LANE WHEN NO LANE CONTROL PRESENT
- B - MAX. DELINEATOR SPACING IN TAPER/WORK ZONE
- C - TRAFFIC CONTROL PERSON SETBACK (m)
- D - DISTANCE BETWEEN CONSTRUCTION SIGNS
- E - BUFFER AREA LENGTH BETWEEN TAPER AND WORK ZONE

NOTES

1. WHERE THE EXISTING SPEED LIMIT IS 50 km/h OR LESS, SPEED SIGNS ARE NOT REQUIRED. REDUCE POSTED SPEED IF HAZARD ASSESSMENT INDICATES SPEED REDUCTION REQUIRED.
2. CONES OR DELINEATOR POSTS MAY BE SUBSTITUTED WITH DRUMS.
3. SIGN OPPOSITE APPROACH IN SAME MANNER EXCEPT USE SIGN TC-5L INSTEAD OF SIGN TC-5R AND SIGN TC-6R INSTEAD OF TC-6L.
4. USE SIGN TC-13L IF LENGTH OF DETOUR IS LESS THAN OR EQUAL TO 200 METERS. USE SIGN TC-15L AND SIGN TC-15R IF DETOUR IS OVER 200 METERS LONG
5. TC-8 MAY BE REPLACED WITH A CONTROL VEHICLE WITH FAB FOR VERY SHORT AND SHORT DURATION

752-20

TRAFFIC CONTROL MANUAL 2018

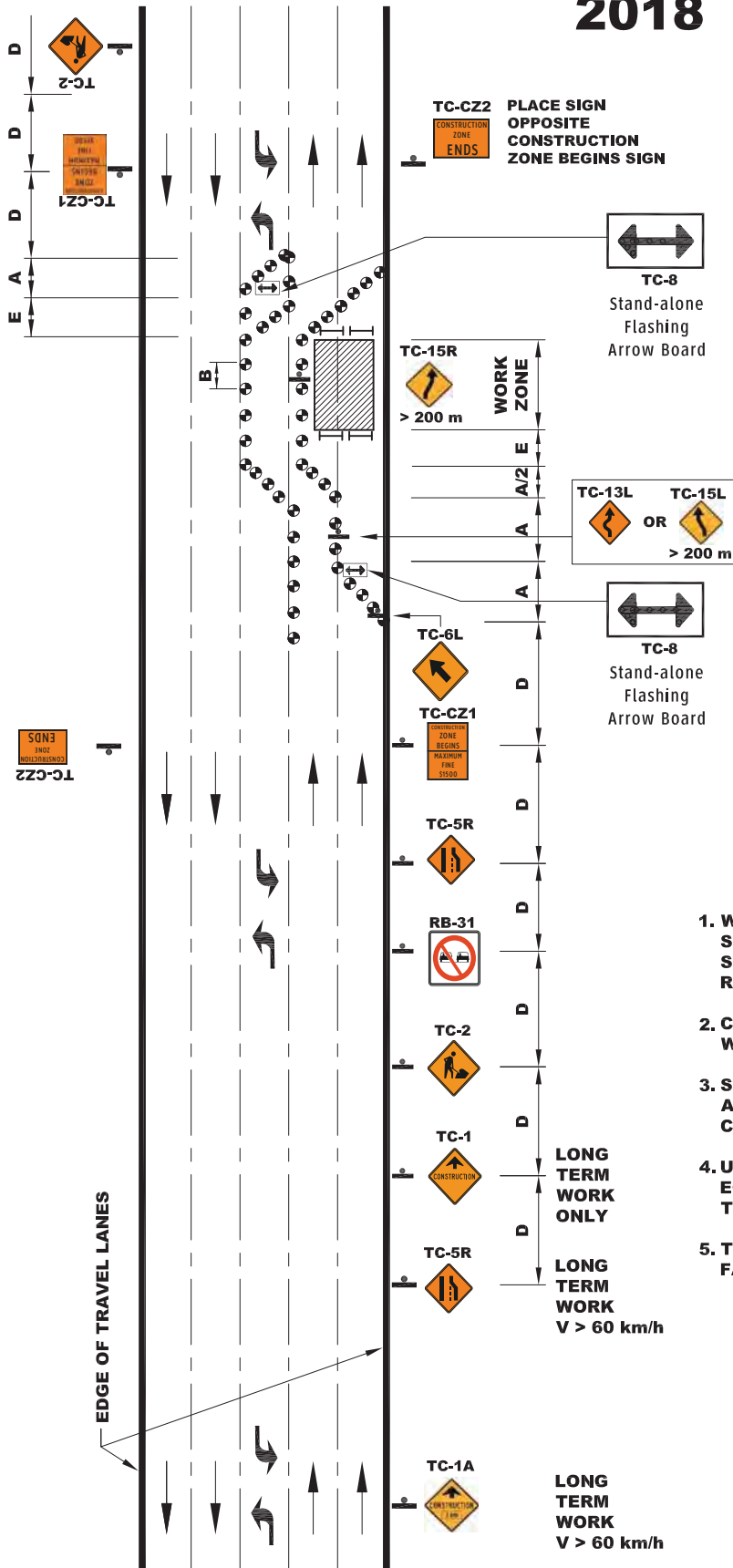

WORK ZONE DIMENSIONS FOR FIVE LANE ROAD TWO RIGHT LANES CLOSED VERY SHORT, SHORT & LONG TERM WORK

DIMENSION (m)	NORMAL POSTED REGULATORY SPEED					
	50	60	70	80	90	100
A	30	40	60	90	110	180
B	5/8	8/12	10/15	10/15	12/18	15/20
C	30	40	40	50	50	50
D	50	50	75	100	100	150
E	35	50	50	75	75	75

POSTED SPEED IS EXISTING SPEED LIMIT (km/h)

- A - TAPER LANE WHEN NO LANE CONTROL PRESENT
- B - MAX. DELINEATOR SPACING IN TAPER/WORK ZONE
- C - TRAFFIC CONTROL PERSON SETBACK (m)
- D - DISTANCE BETWEEN CONSTRUCTION SIGNS
- E - BUFFER AREA LENGTH BETWEEN TAPER AND WORK ZONE

NOTES

- WHERE THE EXISTING SPEED LIMIT IS 50 km/h OR LESS, SPEED SIGNS ARE NOT REQUIRED. REDUCE POSTED SPEED IF HAZARD ASSESSMENT INDICATES SPEED REDUCTION REQUIRED.
- CONES OR DELINEATOR POSTS MAY BE SUBSTITUTED WITH DRUMS.
- SIGN OPPOSITE APPROACH WITH CONSTRUCTION AHEAD AND MEN WORKING SIGNAGE BUT WITHOUT LANE CLOSURE SIGNAGE.
- USE SIGN TC-13L IF LENGTH OF DETOUR IS LESS THAN OR EQUAL TO 200 METERS. USE SIGN TC-15L AND SIGN TC-15R IF DETOUR IS OVER 200 METERS LONG
- TC-8 MAY BE REPLACED WITH A CONTROL VEHICLE WITH FAB FOR VERY SHORT AND SHORT DURATION

752-21

TRAFFIC CONTROL MANUAL

2018

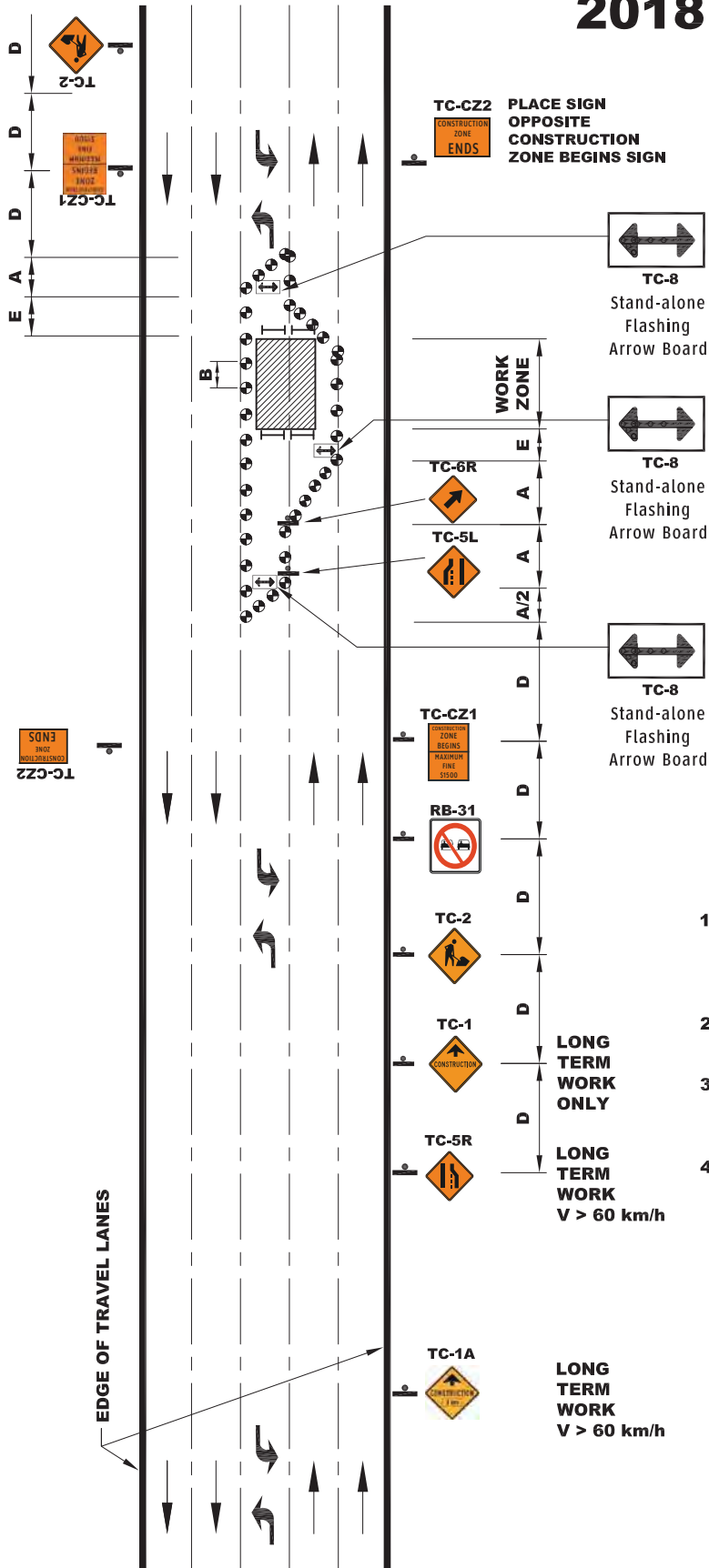

WORK ZONE DIMENSIONS FOR FIVE LANE ROAD TWO-WAY LEFT TURN LANE AND LEFT LANE CLOSED VERY SHORT, SHORT & LONG TERM WORK

DIMENSION (m)	NORMAL POSTED REGULATORY SPEED					
	50	60	70	80	90	100
A	30	40	60	90	110	180
B	5/8	8/12	10/15	10/15	12/18	15/20
C	30	40	40	50	50	50
D	50	50	75	100	100	150
E	35	50	50	75	75	75

POSTED SPEED IS EXISTING SPEED LIMIT (km/h)

- A - TAPER LANE WHEN NO LANE CONTROL PRESENT
- B - MAX. DELINEATOR SPACING IN TAPER/WORK ZONE
- C - TRAFFIC CONTROL PERSON SETBACK (m)
- D - DISTANCE BETWEEN CONSTRUCTION SIGNS
- E - BUFFER AREA LENGTH BETWEEN TAPER AND WORK ZONE

NOTES

- WHERE THE EXISTING SPEED LIMIT IS 50 km/h OR LESS, SPEED SIGNS ARE NOT REQUIRED. REDUCE POSTED SPEED IF HAZARD ASSESSMENT INDICATES SPEED REDUCTION REQUIRED.
- CONES OR DELINEATOR POSTS MAY BE SUBSTITUTED WITH DRUMS.
- SIGN OPPOSITE APPROACH WITH CONSTRUCTION AHEAD AND MEN WORKING SIGNAGE BUT WITHOUT LANE CLOSURE SIGNAGE.
- TC-8 MAY BE REPLACED WITH A CONTROL VEHICLE WITH FAB FOR VERY SHORT AND SHORT DURATION

752-22

TRAFFIC CONTROL MANUAL 2018

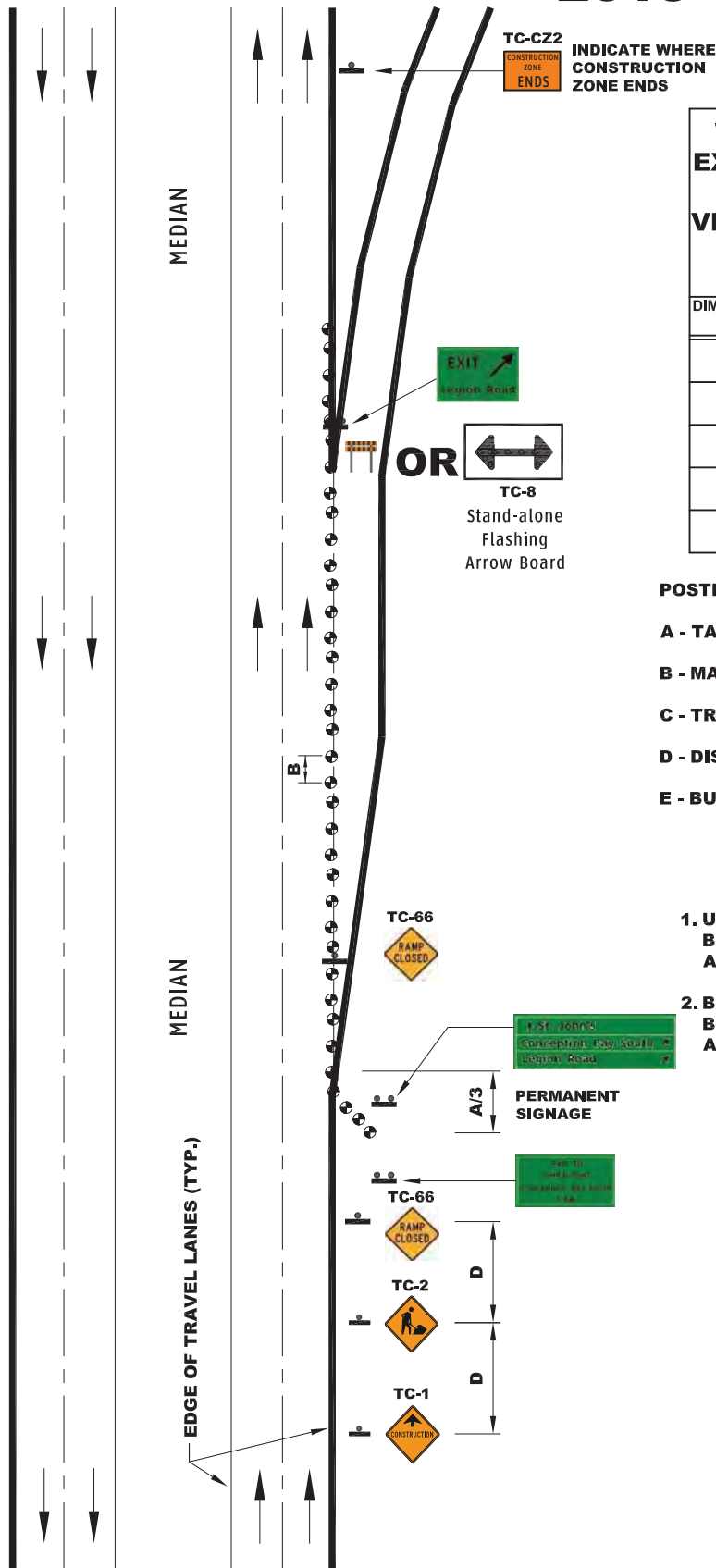

WORK ZONE DIMENSIONS FOR EXIT RAMP CLOSURE DIVIDED OR UNDIVIDED HIGHWAY FOR VERY SHORT & SHORT DURATION

DIMENSION (m)	NORMAL POSTED REGULATORY SPEED					
	50	60	70	80	90	100
A	30	40	60	90	110	180
B	5/8	8/12	10/15	10/15	12/18	15/20
C	30	40	40	50	50	50
D	50	50	75	100	100	150
E	35	50	50	75	75	75

POSTED SPEED IS EXISTING SPEED LIMIT (km/h)

- A - TAPER LANE WHEN NO LANE CONTROL PRESENT
- B - MAX. DELINEATOR SPACING IN TAPER/WORK ZONE
- C - TRAFFIC CONTROL PERSON SETBACK (m)
- D - DISTANCE BETWEEN CONSTRUCTION SIGNS
- E - BUFFER AREA LENGTH BETWEEN TAPER AND WORK ZONE

NOTES

1. USE TRAFFIC CONES IN A TAPER UP TO A DISTANCE A/3 BEFORE START OF RAMP TO INDICATE A CLOSED RAMP IN ADVANCE OF THE TAPER.
2. BARRICADE MAY BE REPLACED BY A FLASHING ARROW BOARD TO CLOSE RAMP AT THE RAMP GORE/BULLNOSE AREA.

752-23

TRAFFIC CONTROL MANUAL 2018

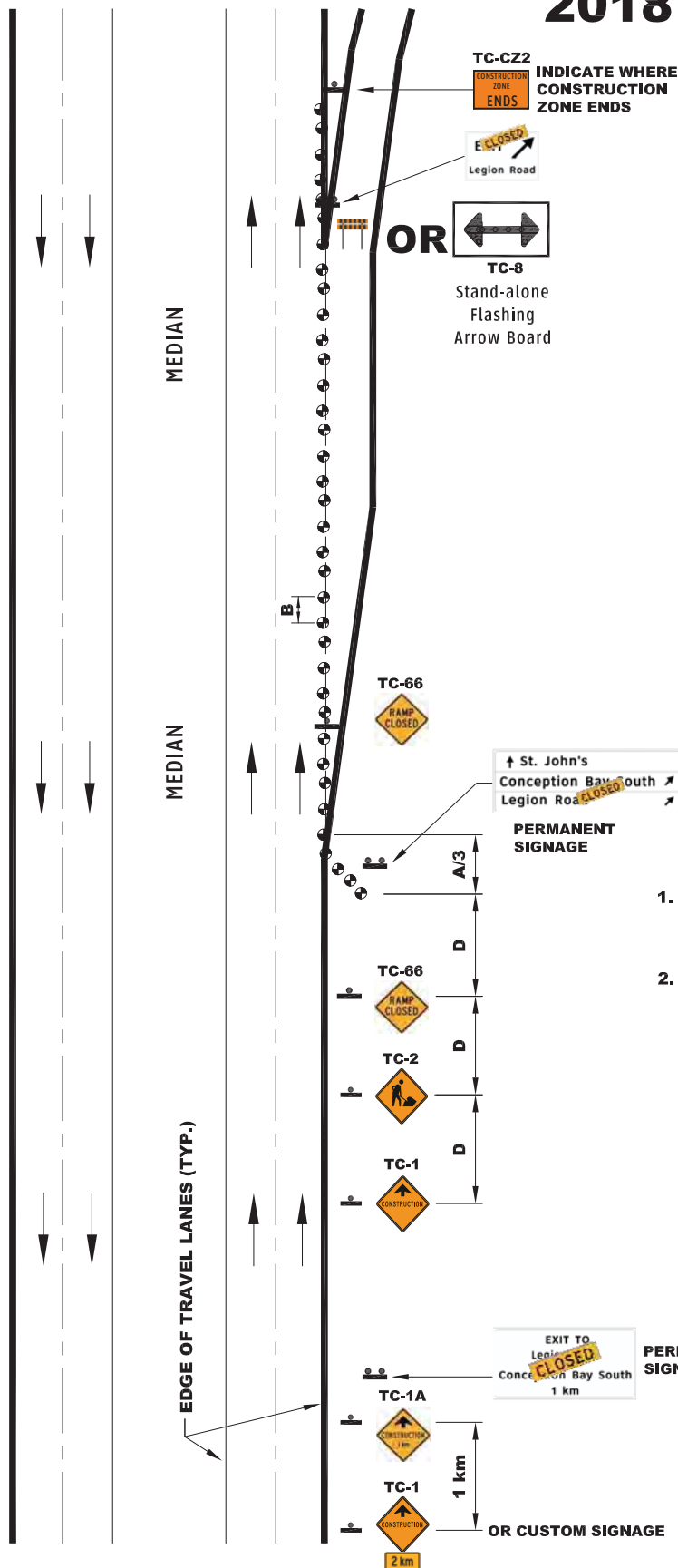

WORK ZONE DIMENSIONS FOR RAMP CLOSURE DIVIDED OR UNDIVIDED HIGHWAY FOR LONG DURATION

DIMENSION (m)	NORMAL POSTED REGULATORY SPEED					
	50	60	70	80	90	100
A	30	40	60	90	110	180
B	5/8	8/12	10/15	10/15	12/18	15/20
C	30	40	40	50	50	50
D	50	50	75	100	100	150
E	35	50	50	75	75	75

POSTED SPEED IS EXISTING SPEED LIMIT (km/h)

A - TAPER LANE WHEN NO LANE CONTROL PRESENT

B - MAX. DELINEATOR SPACING IN TAPER/WORK ZONE

C - TRAFFIC CONTROL PERSON SETBACK (m)

D - DISTANCE BETWEEN CONSTRUCTION SIGNS

E - BUFFER AREA LENGTH BETWEEN TAPER AND WORK ZONE

NOTES

- USE TRAFFIC CONES IN A TAPER UP TO A DISTANCE A/3 BEFORE START OF RAMP TO INDICATE A CLOSED RAMP IN ADVANCE OF THE TAPER.
- BARRICADE MAY BE REPLACED BY A FLASHING ARROW BOARD TO CLOSE RAMP AT THE RAMP GORE/BULLNOSE AREA.

752-24

TRAFFIC CONTROL MANUAL

2018

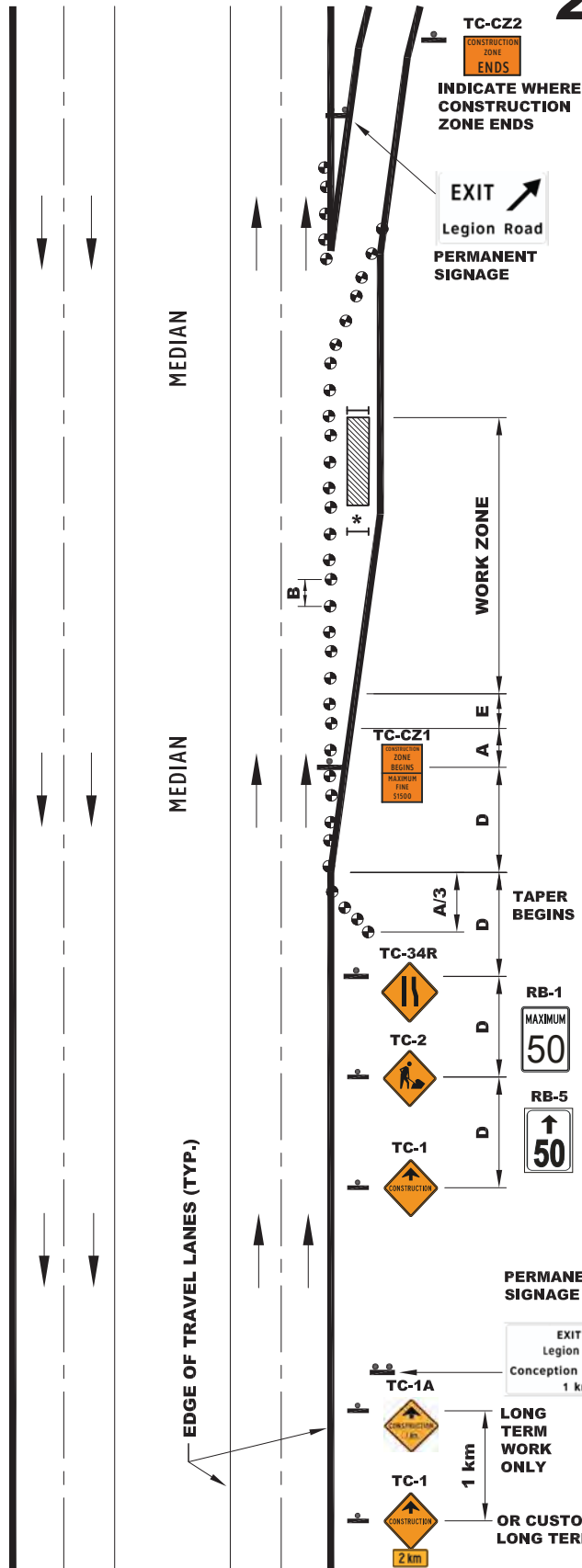

WORK ZONE DIMENSIONS FOR PORTION OF EXIT LANE CLOSURE DIVIDED & UNDIVIDED HIGHWAY VERY SHORT, SHORT, LONG TERM

DIMENSION (m)	NORMAL POSTED REGULATORY SPEED					
	50	60	70	80	90	100
A	30	40	60	90	110	180
B	5/8	8/12	10/15	10/15	12/18	15/20
C	30	40	40	50	50	50
D	50	50	75	100	100	150
E	35	50	50	75	75	75

POSTED SPEED IS EXISTING SPEED LIMIT (km/h)

- A - TAPER LANE WHEN NO LANE CONTROL PRESENT
- B - MAX. DELINEATOR SPACING IN TAPER/WORK ZONE
- C - TRAFFIC CONTROL PERSON SETBACK (m)
- D - DISTANCE BETWEEN CONSTRUCTION SIGNS
- E - BUFFER AREA LENGTH BETWEEN TAPER AND WORK ZONE

NOTES

1. USE TRAFFIC CONES IN A TAPER UP TO A DISTANCE A/3 BEFORE START OF LANE TAPER TO INDICATE A CLOSED PORTION OF AN EXIT LANE IN ADVANCE OF THE TAPER.
 2. WHERE THE EXISTING SPEED LIMIT IS 50 km/h OR LESS, SPEED SIGNS ARE NOT REQUIRED. REDUCE POSTED SPEED LIMIT IF HAZARD ASSESSMENT INDICATES SPEED REDUCTION REQUIRED.
 3. CONES OR DELINEATOR POSTS MAY BE SUBSTITUTED WITH DRUMS.
 4. ON AN UNDIVIDED HIGHWAY SIGN OPPOSITE MAIN LINE APPROACH IN THE SAME MANNER, WITHOUT THE ROAD NARROWS SIGN TC-34R.
 5. CONSTRUCTION ZONE ENDS SIGN TO BE PLACED DIRECTLY ACROSS FROM CONSTRUCTION ZONE BEGINS SIGN ON OPPOSITE APPROACH OF AN UNDIVIDED HIGHWAY.
- * CONTROL VEHICLE WITH "FAB" REQUIRED WHEN CLOSING A TAPER LANE ON A BRIDGE/STRUCTURE.

752-25

TRAFFIC CONTROL MANUAL

2018

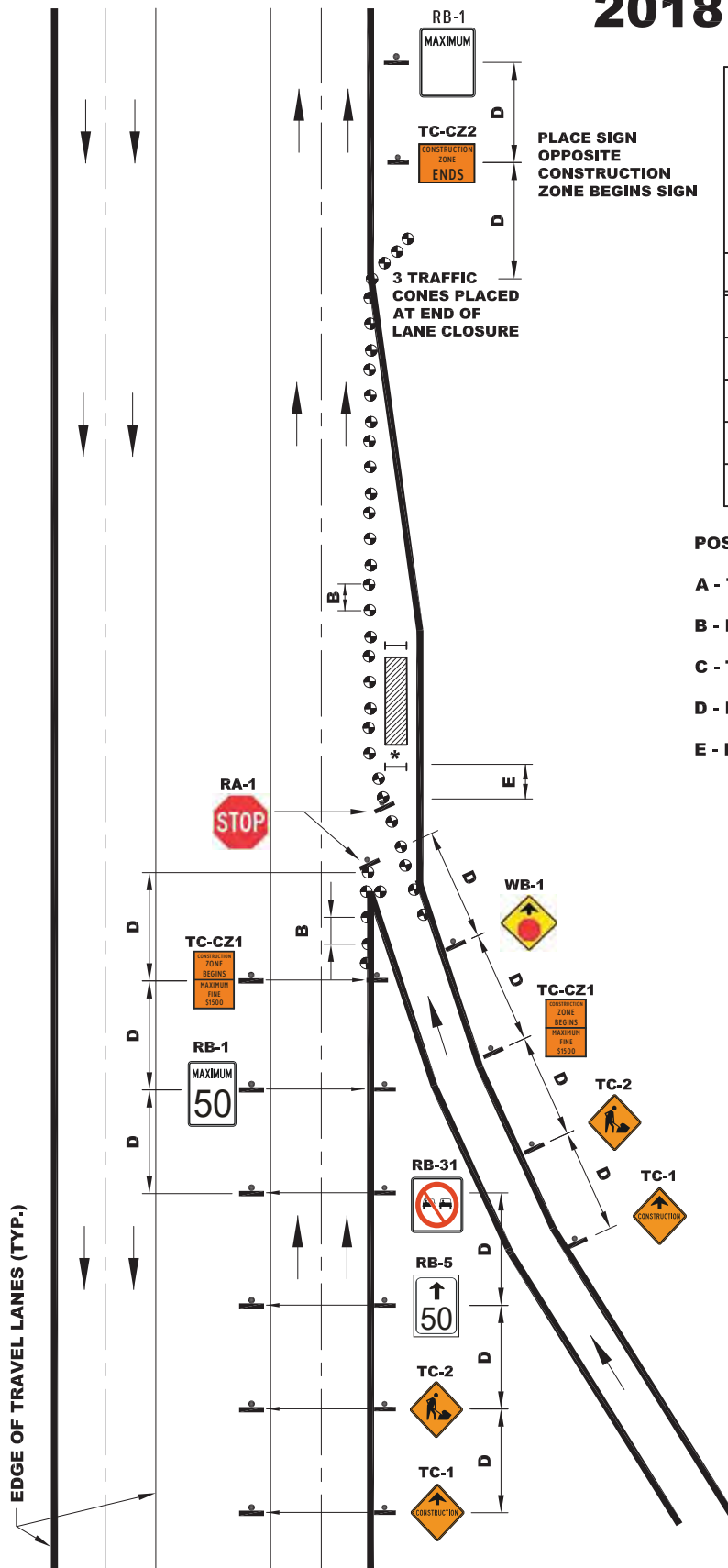

WORK ZONE DIMENSIONS FOR PORTION OF ENTRANCE LANE CLOSED DIVIDED & UNDIVIDED HIGHWAY VERY SHORT, SHORT, LONG TERM

DIMENSION (m)	NORMAL POSTED REGULATORY SPEED					
	50	60	70	80	90	100
A	30	40	60	90	110	180
B	5/8	8/12	10/15	10/15	12/18	15/20
C	30	40	40	50	50	50
D	50	50	75	100	100	150
E	35	50	50	75	75	75

POSTED SPEED IS EXISTING SPEED LIMIT (km/h)

A - TAPER LANE WHEN NO LANE CONTROL PRESENT

B - MAX. DELINEATOR SPACING IN TAPER/WORK ZONE

C - TRAFFIC CONTROL PERSON SETBACK (m)

D - DISTANCE BETWEEN CONSTRUCTION SIGNS

E - BUFFER AREA LENGTH BETWEEN TAPER AND WORK ZONE

NOTES

- USE TRAFFIC CONES FOR A DISTANCE "D" ON MAIN LINE BEFORE "STOP" SIGN ON RAMP TO INDICATE THE CLOSED PORTION OF AN ENTRANCE LANE.
 - WHERE THE EXISTING SPEED LIMIT IS 50 km/h OR LESS, SPEED SIGNS ARE NOT REQUIRED. REDUCE POSTED SPEED LIMIT IF HAZARD ASSESSMENT INDICATES SPEED REDUCTION REQUIRED.
 - CONES OR DELINEATOR POSTS MAY BE SUBSTITUTED WITH DRUMS.
 - ON AN UNDIVIDED HIGHWAY, SIGN OPPOSITE MAIN LINE APPROACH IN THE SAME MANNER, STARTING WITH CONSTRUCTION BEGINS SIGN TC-CZ1 OPPOSITE CONSTRUCTION ENDS SIGN TC-CZ2.
 - CONSTRUCTION ZONE ENDS SIGN TO BE PLACED DIRECTLY ACROSS FROM CONSTRUCTION ZONE BEGINS SIGN ON OPPOSITE APPROACH OF AN UNDIVIDED HIGHWAY.
- * CONTROL VEHICLE WITH "FAB" REQUIRED WHEN CLOSING A TAPER LANE ON A BRIDGE/STRUCTURE.

752-26

TRAFFIC CONTROL MANUAL

2018

WORK ZONE DIMENSIONS FOR RIGHT CLIMBING LANE CLOSED SPEED LIMIT \geq 60 km/h

DIMENSION (m)	NORMAL POSTED REGULATORY SPEED				
	60	70	80	90	100
A	40	60	90	110	180
B	8/12	10/15	10/15	12/18	15/20
C	40	40	50	50	50
D	50	75	100	100	150
E	50	50	75	75	75

POSTED SPEED IS EXISTING SPEED LIMIT (km/h)

A - TAPER LANE WHEN NO LANE CONTROL PRESENT

B - MAX. DELINEATOR SPACING IN TAPER/WORK ZONE

C - TRAFFIC CONTROL PERSON SETBACK (m)

D - DISTANCE BETWEEN CONSTRUCTION SIGNS

E - BUFFER AREA LENGTH BETWEEN TAPER AND WORK ZONE

NOTES

1. DURING DARKNESS, FOR HIGHWAYS WITH A SPEED LIMIT OF 90 km/h OR HIGHER, LANE CLOSURES THAT ARE ANTICIPATED TO BE IN PLACE 12 HOURS OR GREATER SHALL HAVE A FLASHING ARROW BOARD LIGHT TRAILER UNIT LOCATED AT THE SPECIFIED BUFFER DISTANCE FROM THE WORK AREA.
2. A DEDICATED TRAFFIC OBSERVER IS AN INDIVIDUAL WHOSE SOLE RESPONSIBILITY IS TO MONITOR APPROACHING TRAFFIC AND WARN WORKERS OF POTENTIAL HAZARDS.
3. "CLIMBING LANE AHEAD" AND "KEEP RIGHT EXCEPT TO PASS" SIGNS MUST BE COVERED.
4. IF LESS THAN 1 km OF CLIMBING LANE REMAINS BEYOND THE WORK ZONE, CLOSE THE ENTIRE CLIMBING LANE.
5. IF MORE THAN 1 km OF CLIMBING LANE REMAINS BEYOND THE WORK ZONE, A KEEP RIGHT EXCEPT TO PASS SIGN SHALL BE POSTED IMMEDIATELY FOLLOWING THE END TAPER.
6. DUPLICATE SIGNS FROM OTHER DIRECTION.
7. LINE OF SIGHT SHALL BE MAINTAINED FROM A DEDICATED TRAFFIC OBSERVER TO APPROACHING TRAFFIC (REFER TO DRAWINGS 757-1 AND/OR 757-2).

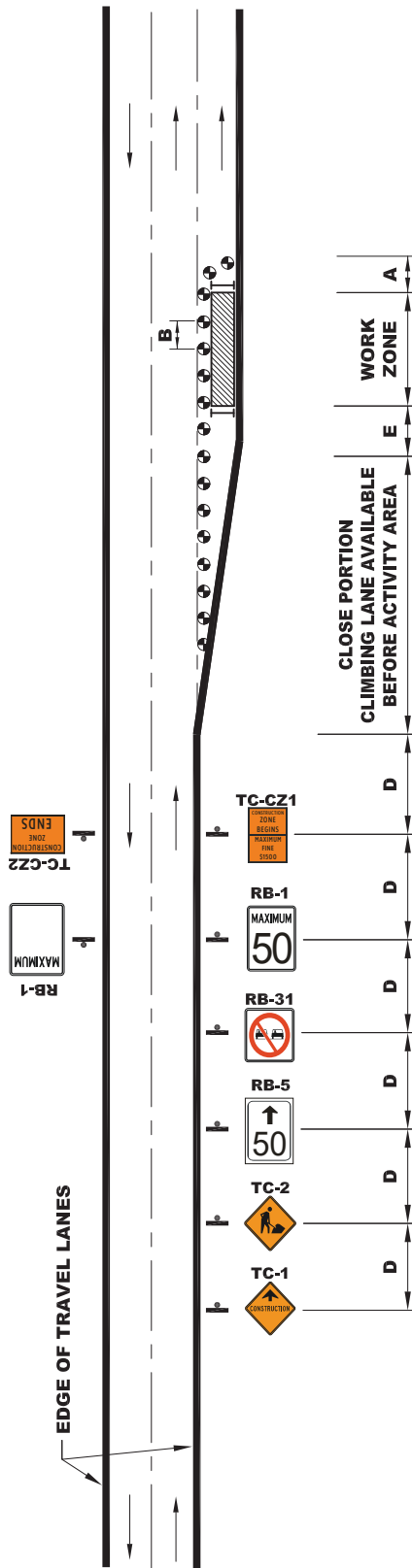

752-27



TRANSPORTATION AND WORKS
HIGHWAY DESIGN DIVISION

CLIMBING LANE CLOSED
SPEED GREATER THAN OR EQUAL TO 60 km/h
SHORT AND LONG TERM UNDIVIDED

DRAWN BY: G. CLARKE

DATE: Rev November 2018 NOT TO SCALE

TRAFFIC CONTROL MANUAL

2018

WORK ZONE DIMENSIONS FOR CENTER CLIMBING LANE CLOSED FROM START OF TAPER SPEED LIMIT \geq 60 km/h

DIMENSION (m)	NORMAL POSTED REGULATORY SPEED				
	60	70	80	90	100
A	40	60	90	110	180
B	8/12	10/15	10/15	12/18	15/20
C	40	40	50	50	50
D	50	75	100	100	150
E	50	50	75	75	75

POSTED SPEED IS EXISTING SPEED LIMIT (km/h)

A - TAPER LANE WHEN NO LANE CONTROL PRESENT

B - MAX. DELINEATOR SPACING IN TAPER/WORK ZONE

C - TRAFFIC CONTROL PERSON SETBACK (m)

D - DISTANCE BETWEEN CONSTRUCTION SIGNS

E - BUFFER AREA LENGTH BETWEEN TAPER AND WORK ZONE

NOTES

1. DURING DARKNESS, FOR HIGHWAYS WITH A SPEED LIMIT OF 90 km/h OR HIGHER, LANE CLOSURES THAT ARE ANTICIPATED TO BE IN PLACE 12 HOURS OR GREATER SHALL HAVE A FLASHING ARROW BOARD LIGHT TRAILER UNIT LOCATED AT THE SPECIFIED TAPER DISTANCE FROM THE WORK AREA.
2. A DEDICATED TRAFFIC OBSERVER IS AN INDIVIDUAL WHOSE SOLE RESPONSIBILITY IS TO MONITOR APPROACHING TRAFFIC AND WARN WORKERS OF POTENTIAL HAZARDS.
3. "CLIMBING LANE AHEAD" AND "KEEP RIGHT EXCEPT TO PASS" SIGNS MUST BE COVERED.
4. IF LESS THAN 1 km OF CLIMBING LANE REMAINS BEYOND THE WORK ZONE, CLOSE THE ENTIRE CLIMBING LANE.
5. IF MORE THAN 1 km OF CLIMBING LANE REMAINS BEYOND THE WORK ZONE, A KEEP RIGHT EXCEPT TO PASS SIGN SHALL BE POSTED IMMEDIATELY FOLLOWING THE END TAPER.
6. DUPLICATE SIGNS FROM OTHER DIRECTION.
7. LINE OF SIGHT SHALL BE MAINTAINED FROM A DEDICATED TRAFFIC OBSERVER TO APPROACHING TRAFFIC (REFER TO DRAWINGS 757-1 AND/OR 757-2).
8. TC-8 MAY BE REPLACED WITH A CONTROL VEHICLE WITH FAB FOR SHORT DURATION

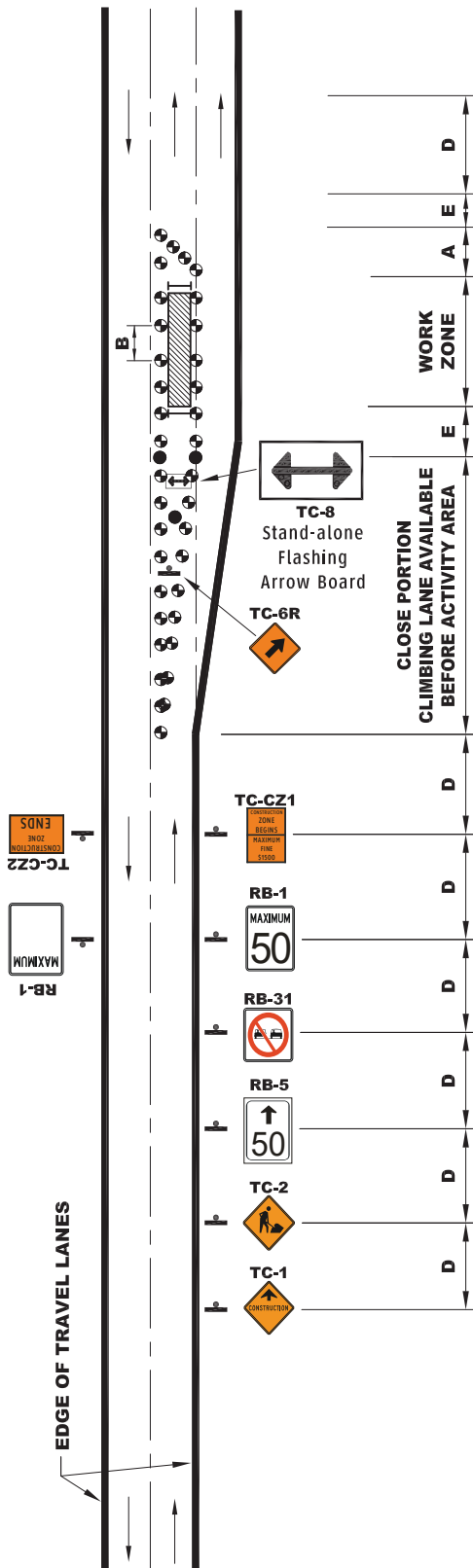

752-28



TRANSPORTATION AND WORKS
HIGHWAY DESIGN DIVISION

**CENTER CLIMBING LANE CLOSED AT START
GREATER THAN OR EQUAL TO 60 km/h
SHORT AND LONG TERM UNDIVIDED**

DRAWN BY: G. CLARKE

DATE: Rev November 2018 NOT TO SCALE

TRAFFIC CONTROL MANUAL

2018

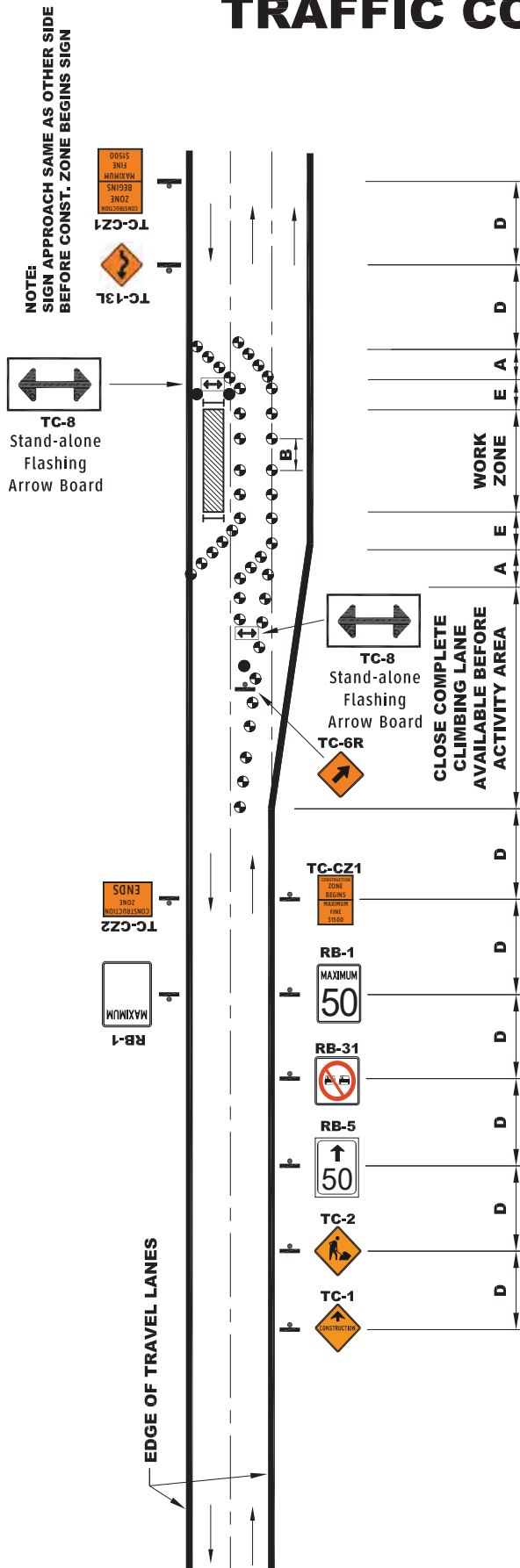

WORK ZONE DIMENSIONS FOR LANE CLOSED OPPOSITE A CLIMBING LANE SPEED LIMIT ≥ 60 km/h

DIMENSION (m)	NORMAL POSTED REGULATORY SPEED				
	60	70	80	90	100
A	40	60	90	110	180
B	8/12	10/15	10/15	12/18	15/20
C	40	40	50	50	50
D	50	75	100	100	150
E	50	50	75	75	75

POSTED SPEED IS EXISTING SPEED LIMIT (km/h)

A - TAPER LANE WHEN NO LANE CONTROL PRESENT

B - MAX. DELINEATOR SPACING IN TAPER/WORK ZONE

C - TRAFFIC CONTROL PERSON SETBACK (m)

D - DISTANCE BETWEEN CONSTRUCTION SIGNS

E - BUFFER AREA LENGTH BETWEEN TAPER AND WORK ZONE

NOTES

1. DURING DARKNESS, FOR HIGHWAYS WITH A SPEED LIMIT OF 90 km/h OR HIGHER, LANE CLOSURES THAT ARE ANTICIPATED TO BE IN PLACE 12 HOURS OR GREATER SHALL HAVE A FLASHING ARROW LIGHT BOARD TRAILER UNIT LOCATED AT THE SPECIFIED BUFFER DISTANCE FROM THE WORK AREA.
2. LINE OF SIGHT MUST BE MAINTAINED FROM A FLAGPERSON OR DEDICATED TRAFFIC OBSERVER TO APPROACH TRAFFIC. REFER TO DRAWINGS 757-1 AND/OR 757-2. A DEDICATED TRAFFIC OBSERVER IS AN INDIVIDUAL WHOSE SOLE RESPONSIBILITY IS TO MONITOR APPROACHING TRAFFIC AND WARN WORKERS OF POTENTIAL HAZARDS.
3. "CLIMBING LANE AHEAD" AND "KEEP RIGHT EXCEPT TO PASS" SIGNS MUST BE COVERED. "YIELD TO ONCOMING TRAFFIC" SIGNS MUST BE COVERED IN NO PASSING ZONES.
4. IF LESS THAN 1 km OF CLIMBING LANE REMAINS BEYOND THE WORK ZONE, CLOSE THE ENTIRE CLIMBING LANE.
5. IF MORE THAN 1 km OF CLIMBING LANE REMAINS BEYOND THE WORK ZONE, A KEEP RIGHT EXCEPT TO PASS SIGN SHALL BE POSTED IMMEDIATELY FOLLOWING THE END TAPER AND THE ORIGINAL POSTED SPEED SHALL BE REINSTATED DIRECTLY ACROSS FROM THE REDUCED SPEED SIGN ON THE OPPOSITE APPROACH.
6. DUPLICATE SIGNS FROM OTHER DIRECTION.
7. TC-8 MAY BE REPLACED WITH A CONTROL VEHICLE WITH FAB FOR SHORT DURATION.

752-29



TRANSPORTATION AND WORKS
HIGHWAY DESIGN DIVISION

LANE CLOSED OPPOSITE A CLIMBING LANE GREATER THAN OR EQUAL TO 60 km/h SHORT & LONG TERM UNDIVIDED

DRAWN BY: G. CLARKE

DATE: Rev November 2018 NOT TO SCALE

TRAFFIC CONTROL MANUAL 2018

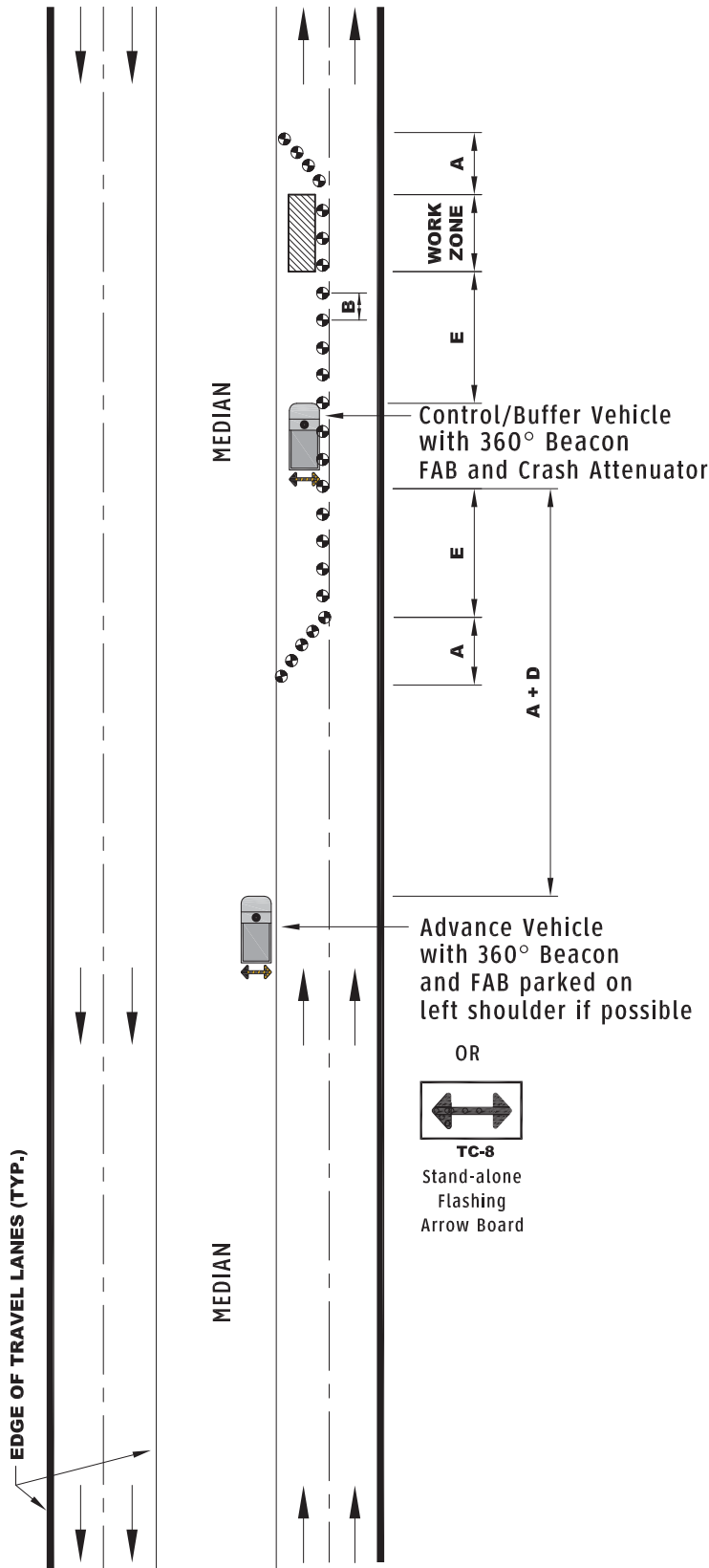

WORK ZONE DIMENSIONS FOR LEFT LANE CLOSED MULTI-LANE DIVIDED HIGHWAY VERY SHORT DURATION WITH CRASH ATTENUATOR						
NORMAL POSTED REGULATORY SPEED						
DIMENSION (m)	50	60	70	80	90	100
A	30	40	60	90	110	180
B	5/8	8/12	10/15	10/15	12/18	15/20
C	30	40	40	50	50	50
D	50	50	75	100	100	150
E	35	50	50	75	75	75

POSTED SPEED IS EXISTING SPEED LIMIT (km/h)

- A - TAPER LANE WHEN NO LANE CONTROL PRESENT
- B - MAX. DELINEATOR SPACING IN TAPER/WORK ZONE
- C - TRAFFIC CONTROL PERSON SETBACK (m)
- D - DISTANCE BETWEEN CONSTRUCTION SIGNS
- E - BUFFER AREA LENGTH BETWEEN TAPER AND WORK ZONE

NOTES

1. ADVANCE VEHICLE IS NOT REQUIRED FOR REGULAR POSTED SPEEDS OF 60 km/h OR LOWER.
2. FLASHING ARROW BOARD (FAB) AND 360° ROTATING TOP MOUNTED BEACON SHALL BE ENGAGED TO REDIRECT TRAFFIC AWAY FROM WORK AND CONTROL/BUFFER VEHICLES.
3. THE WORK SPACE AREA MAY INCLUDE OTHER WORK VEHICLES. ALL WORK VEHICLES IN THE WORK SPACE (DOWNSTREAM OF THE VEHICLE WITH THE CRASH ATTENUATOR) WITH AN ACTIVATED FAB MUST BE IN BAR MODE.



752-30

TRAFFIC CONTROL MANUAL 2018

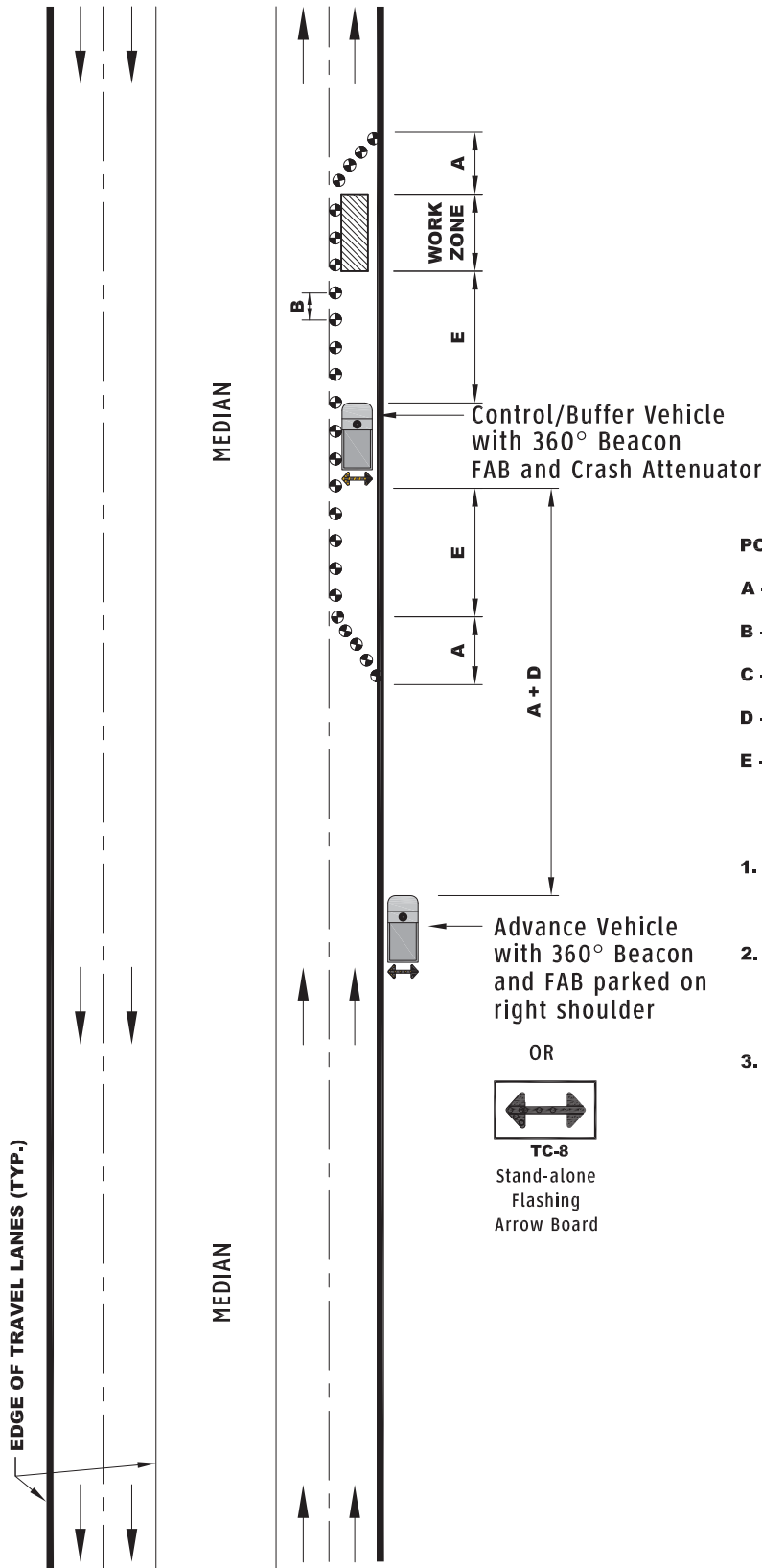

WORK ZONE DIMENSIONS FOR RIGHT LANE CLOSED MULTI-LANE DIVIDED HIGHWAY VERY SHORT DURATION WITH CRASH ATTENUATOR

DIMENSION (m)	NORMAL POSTED REGULATORY SPEED					
	50	60	70	80	90	100
A	30	40	60	90	110	180
B	5/8	8/12	10/15	10/15	12/18	15/20
C	30	40	40	50	50	50
D	50	50	75	100	100	150
E	35	50	50	75	75	75

POSTED SPEED IS EXISTING SPEED LIMIT (km/h)

A - TAPER LANE WHEN NO LANE CONTROL PRESENT

B - MAX. DELINEATOR SPACING IN TAPER/WORK ZONE

C - TRAFFIC CONTROL PERSON SETBACK (m)

D - DISTANCE BETWEEN CONSTRUCTION SIGNS

E - BUFFER AREA LENGTH BETWEEN TAPER AND WORK ZONE

NOTES

1. ADVANCE VEHICLE OR TC-8 STAND-ALONE FLASHING ARROW BOARD IS NOT REQUIRED FOR REGULAR POSTED SPEEDS OF 60 km/h OR LOWER.
2. FLASHING ARROW BOARD (FAB) AND 360° ROTATING TOP MOUNTED BEACON SHALL BE ENGAGED TO REDIRECT TRAFFIC AWAY FROM WORK AND CONTROL/BUFFER VEHICLES.
3. THE WORK SPACE MAY INCLUDE OTHER WORK VEHICLES. ALL WORK VEHICLES IN THE WORK SPACE (DOWNSTREAM OF THE VEHICLE WITH THE CRASH ATTENUATOR) WITH ACTIVATED FAB MUST BE IN BAR MODE.



752-31

TRAFFIC CONTROL MANUAL

2018

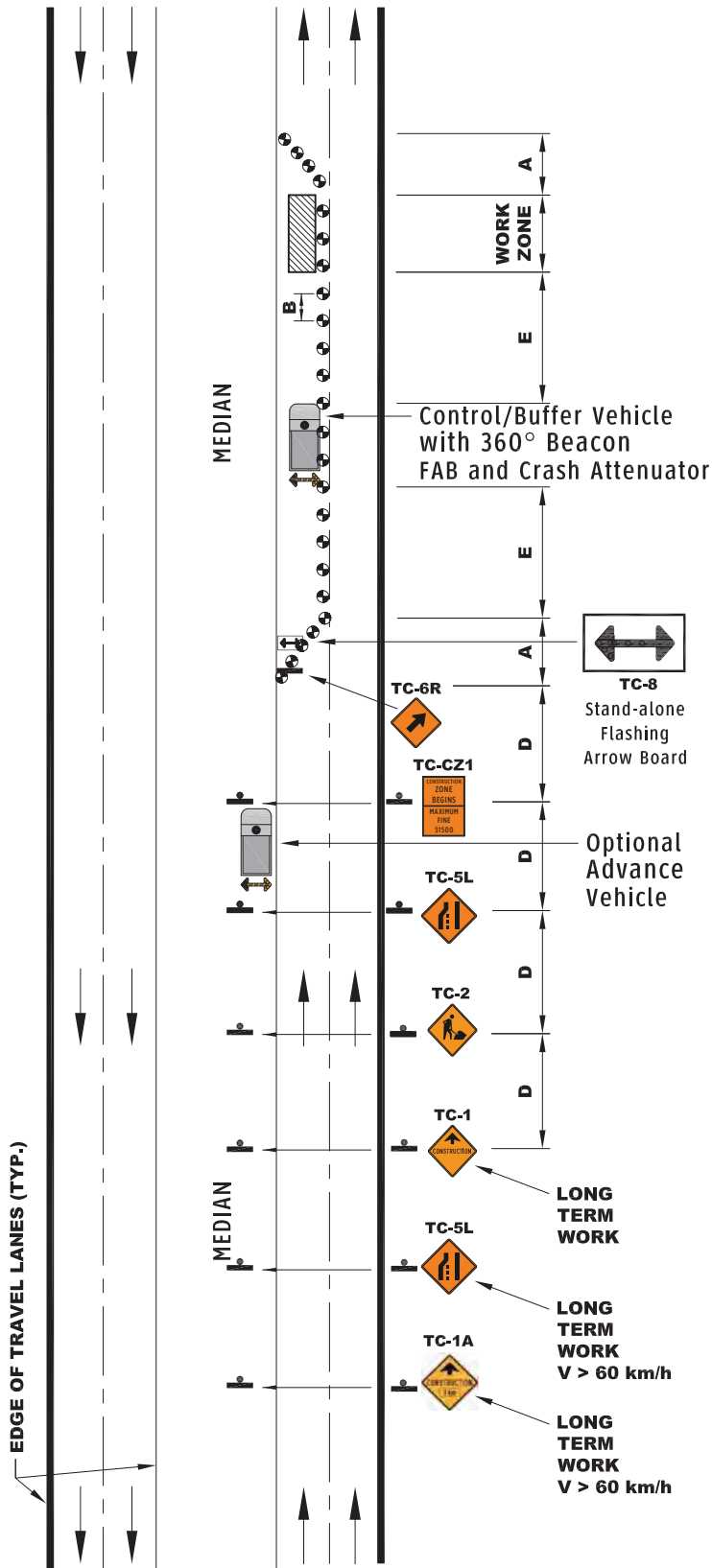

WORK ZONE DIMENSIONS FOR LEFT LANE CLOSED MULTI-LANE DIVIDED HIGHWAY SHORT OR LONG DURATION WITH CRASH ATTENUATOR

DIMENSION (m)	NORMAL POSTED REGULATORY SPEED					
	50	60	70	80	90	100
A	30	40	60	90	110	180
B	5/8	8/12	10/15	10/15	12/18	15/20
C	30	40	40	50	50	50
D	50	50	75	100	100	150
E	35	50	50	75	75	75

POSTED SPEED IS EXISTING SPEED LIMIT (km/h)

- A - TAPER LANE WHEN NO LANE CONTROL PRESENT
- B - MAX. DELINEATOR SPACING IN TAPER/WORK ZONE
- C - TRAFFIC CONTROL PERSON SETBACK (m)
- D - DISTANCE BETWEEN CONSTRUCTION SIGNS
- E - BUFFER AREA LENGTH BETWEEN TAPER AND WORK ZONE

NOTES

1. ADVANCE VEHICLE IS NOT REQUIRED FOR REGULAR POSTED SPEEDS OF 60 km/h OR LOWER.
2. FLASHING ARROW BOARD (FAB) AND 360° ROTATING TOP MOUNTED BEACON SHALL BE ENGAGED TO REDIRECT TRAFFIC AWAY FROM WORK AND CONTROL/BUFFER VEHICLES.
3. THE WORK SPACE AREA MAY INCLUDE OTHER WORK VEHICLES. ALL WORK VEHICLES IN THE WORK SPACE (DOWNSTREAM OF THE VEHICLE WITH THE CRASH ATTENUATOR) WITH AN ACTIVATED FAB MUST BE IN BAR MODE.
4. WHERE SIGNS CANNOT BE ACCOMMODATED IN THE MEDIAN, PROVIDE ADDITIONAL SIGNS ON THE RIGHT SHOULDER, OR OVERSIZE AS PRACTICAL

752-32

TRAFFIC CONTROL MANUAL

2018

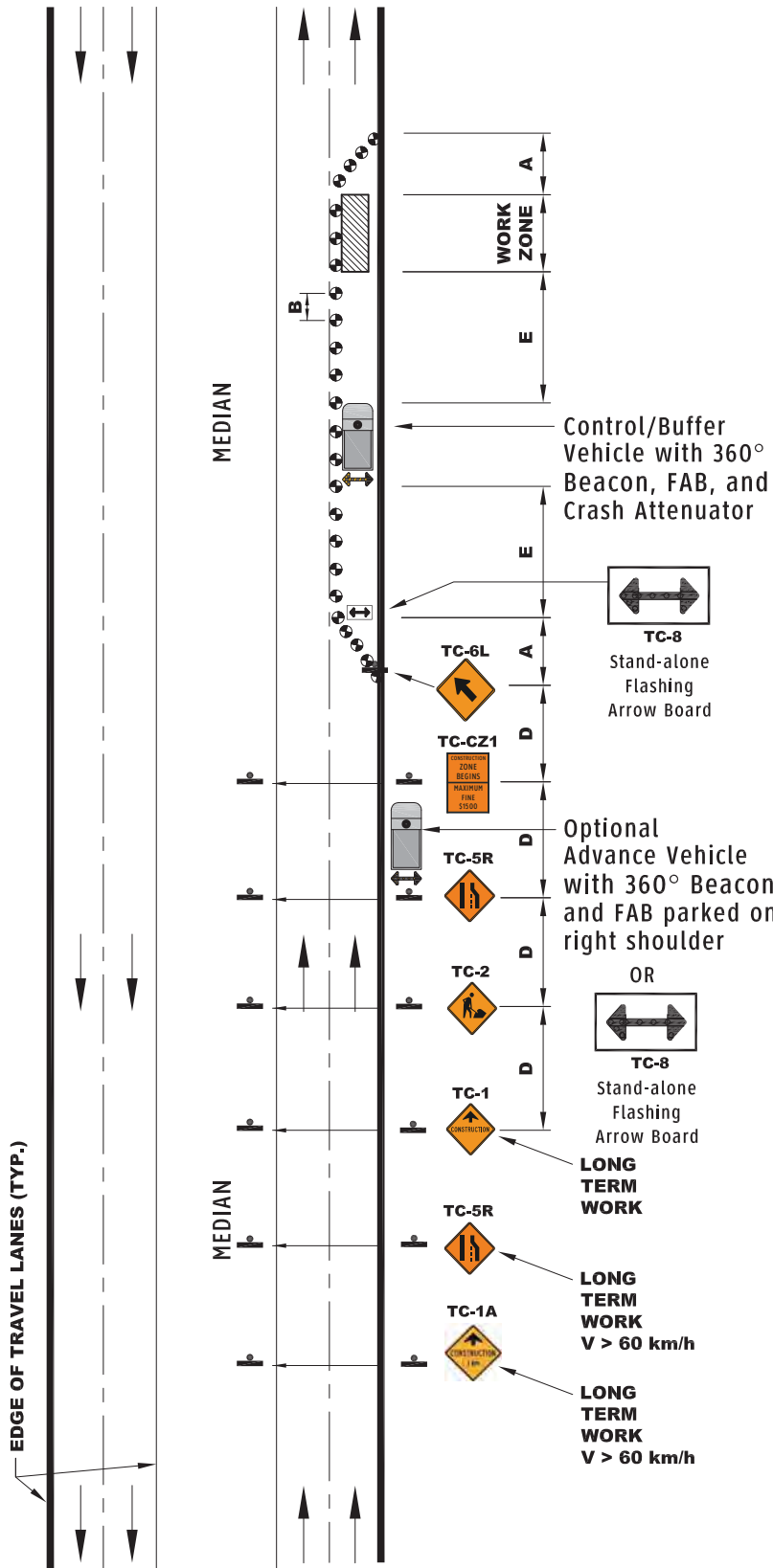

WORK ZONE DIMENSIONS FOR RIGHT LANE CLOSED MULTI-LANE DIVIDED HIGHWAY SHORT OR LONG DURATION WITH CRASH ATTENUATOR

DIMENSION (m)	NORMAL POSTED REGULATORY SPEED					
	50	60	70	80	90	100
A	30	40	60	90	110	180
B	5/8	8/12	10/15	10/15	12/18	15/20
C	30	40	40	50	50	50
D	50	50	75	100	100	150
E	35	50	50	75	75	75

POSTED SPEED IS EXISTING SPEED LIMIT (km/h)

- A - TAPER LANE WHEN NO LANE CONTROL PRESENT
- B - MAX. DELINEATOR SPACING IN TAPER/WORK ZONE
- C - TRAFFIC CONTROL PERSON SETBACK (m)
- D - DISTANCE BETWEEN CONSTRUCTION SIGNS
- E - BUFFER AREA LENGTH BETWEEN TAPER AND WORK ZONE

NOTES

1. ADVANCE VEHICLE IS NOT REQUIRED FOR REGULAR POSTED SPEEDS OF 60 km/h OR LOWER.
2. FLASHING ARROW BOARD (FAB) AND 360° ROTATING TOP MOUNTED BEACON SHALL BE ENGAGED TO REDIRECT TRAFFIC AWAY FROM WORK AND CONTROL/BUFFER VEHICLES.
3. THE WORK SPACE MAY INCLUDE OTHER WORK VEHICLES. ALL WORK VEHICLES IN THE WORK SPACE (DOWNSTREAM OF THE VEHICLE WITH THE CRASH ATTENUATOR) WITH ACTIVATED FAB MUST BE IN BAR MODE.
4. WHERE SIGNS CANNOT BE ACCOMMODATED IN THE MEDIAN, PROVIDE ADDITIONAL SIGNS ON THE RIGHT SHOULDER, OR OVERSIZE AS PRACTICAL.

752-33

TRAFFIC CONTROL MANUAL 2018

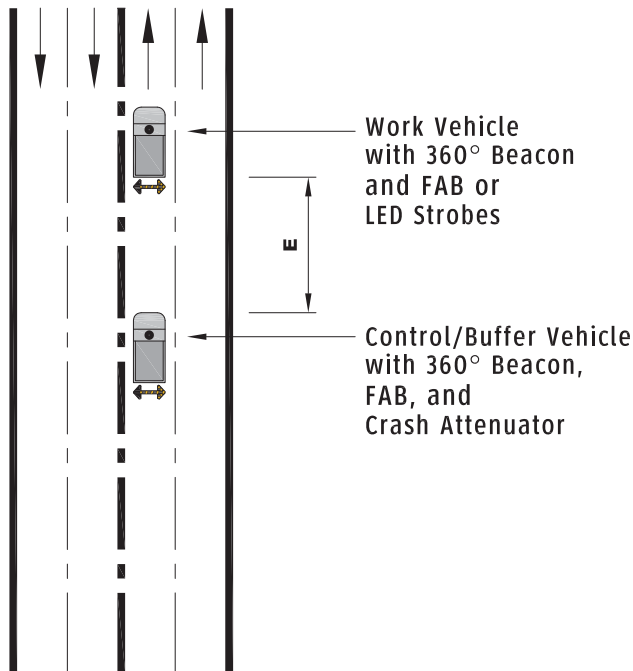

OR

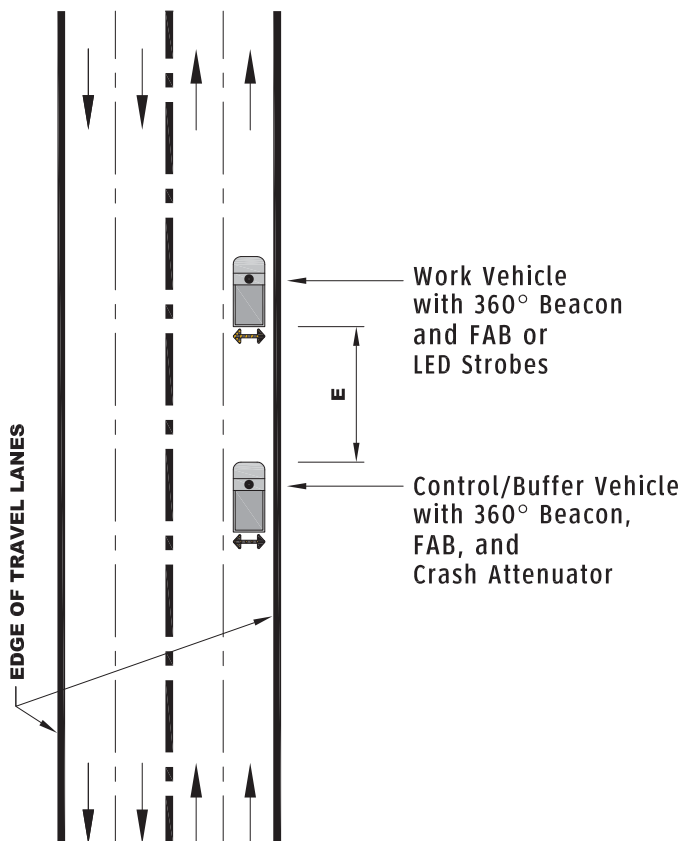

WORK ZONE DIMENSIONS FOR LEFT OR RIGHT LANE CLOSED UNDIVIDED HIGHWAY MOBILE OPERATIONS

DIMENSION (m)	NORMAL POSTED REGULATORY SPEED					
	50	60	70	80	90	100
A	30	40	60	90	110	180
B	5/8	8/12	10/15	10/15	12/18	15/20
C	30	40	40	50	50	50
D	50	50	75	100	100	150
E	35	50	50	75	75	75

POSTED SPEED IS EXISTING SPEED LIMIT (km/h)

A - TAPER LANE WHEN NO LANE CONTROL PRESENT

B - MAX. DELINEATOR SPACING IN TAPER/WORK ZONE

C - TRAFFIC CONTROL PERSON SETBACK (m)

D - DISTANCE BETWEEN CONSTRUCTION SIGNS

E - BUFFER AREA LENGTH BETWEEN TAPER AND WORK ZONE

NOTES

- CONTROL/BUFFER VEHICLE WITH CRASH ATTENUATOR IS NOT REQUIRED FOR REGULAR POSTED SPEEDS OF 60 km/h OR LOWER.
- FLASHING ARROW BOARD (FAB) AND 360° ROTATING TOP MOUNTED BEACON SHALL BE ENGAGED TO REDIRECT DOWNSTREAM TRAFFIC AWAY FROM WORK AND CONTROL/BUFFER VEHICLES.

752-34



TRANSPORTATION AND WORKS
HIGHWAY DESIGN DIVISION

LEFT OR RIGHT LANE CLOSED
MULTI-LANE ROAD - UNDIVIDED HIGHWAY
MOBILE OPERATIONS WITH CRASH ATTENUATOR

DRAWN BY: JM

DATE: Rev November 2018 NOT TO SCALE

TRAFFIC CONTROL MANUAL

2018

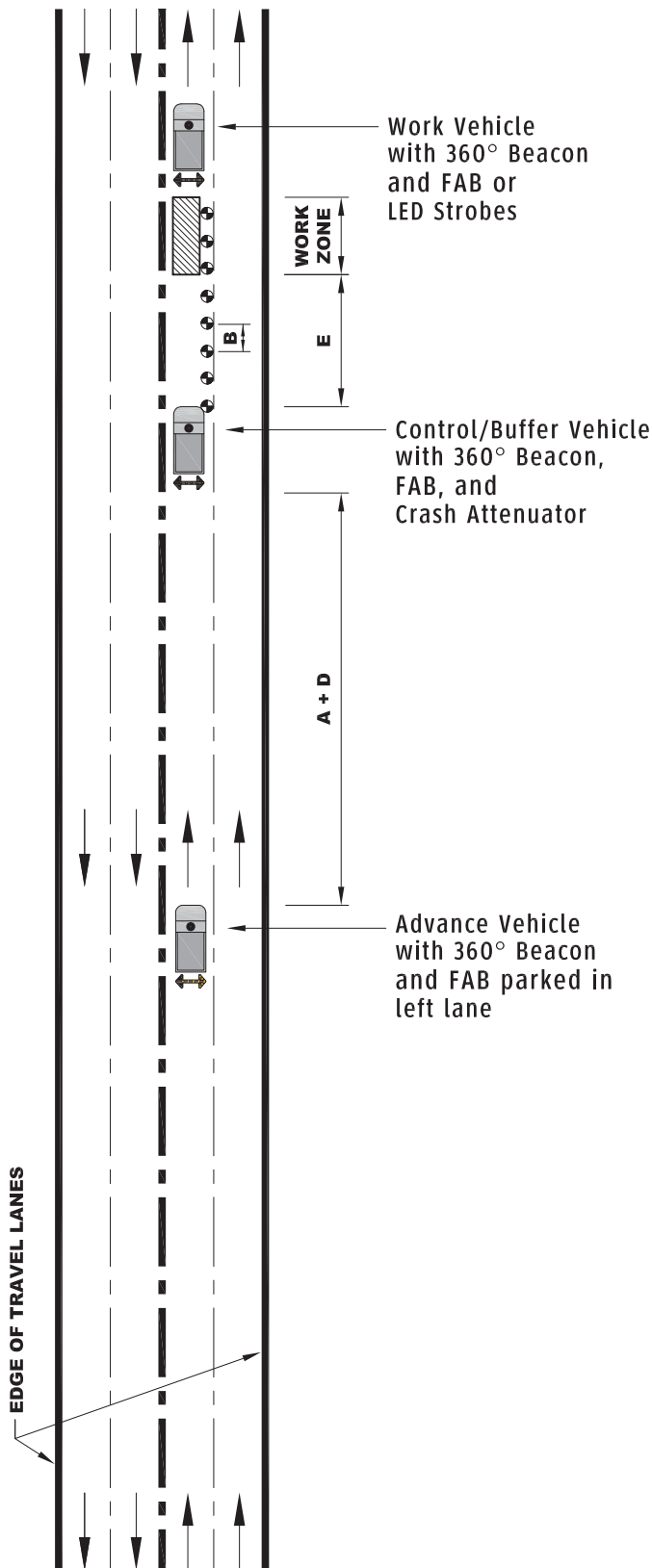

WORK ZONE DIMENSIONS FOR LEFT LANE CLOSED UNDIVIDED HIGHWAY VERY SHORT DURATION

DIMENSION (m)	NORMAL POSTED REGULATORY SPEED					
	50	60	70	80	90	100
A	30	40	60	90	110	180
B	5/8	8/12	10/15	10/15	12/18	15/20
C	30	40	40	50	50	50
D	50	50	75	100	100	150
E	35	50	50	75	75	75

POSTED SPEED IS EXISTING SPEED LIMIT (km/h)

A - TAPER LANE WHEN NO LANE CONTROL PRESENT

B - MAX. DELINEATOR SPACING IN TAPER/WORK ZONE

C - TRAFFIC CONTROL PERSON SETBACK (m)

D - DISTANCE BETWEEN CONSTRUCTION SIGNS

E - BUFFER AREA LENGTH BETWEEN TAPER AND WORK ZONE

NOTES

- ADVANCE VEHICLE IS NOT REQUIRED FOR REGULAR POSTED SPEEDS OF 60 km/h OR LOWER.
- FLASHING ARROW BOARD (FAB) AND 360° ROTATING TOP MOUNTED BEACON SHALL BE ENGAGED TO REDIRECT DOWNSTREAM TRAFFIC AWAY FROM WORK AND CONTROL/BUFFER VEHICLES.
- THE WORK SPACE AREA MAY INCLUDE OTHER WORK VEHICLES. ALL WORK VEHICLES IN THE WORK SPACE (DOWNSTREAM OF THE VEHICLE WITH THE CRASH ATTENUATOR) WITH AN ACTIVATED FAB MUST BE IN BAR MODE.

752-35

TRAFFIC CONTROL MANUAL

2018

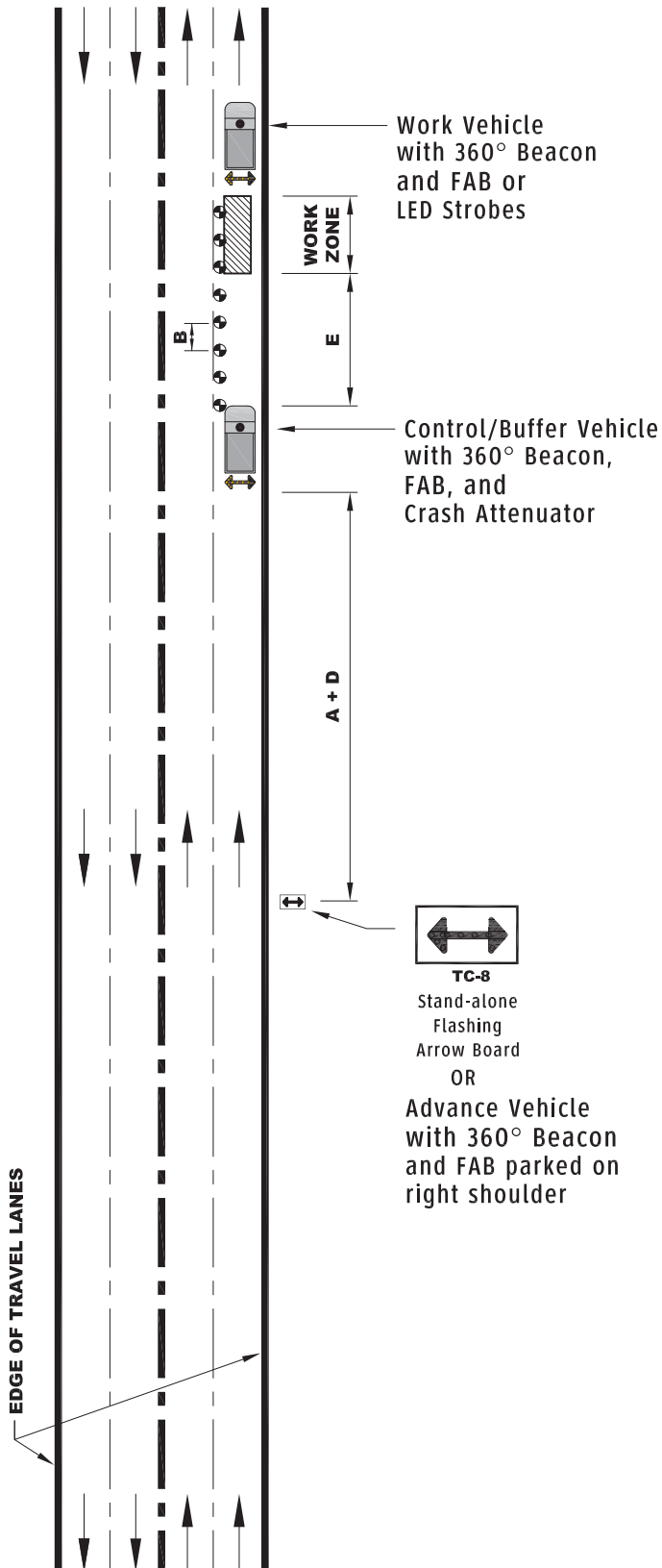

WORK ZONE DIMENSIONS FOR RIGHT LANE CLOSED UNDIVIDED HIGHWAY VERY SHORT DURATION

DIMENSION (m)	NORMAL POSTED REGULATORY SPEED					
	50	60	70	80	90	100
A	30	40	60	90	110	180
B	5/8	8/12	10/15	10/15	12/18	15/20
C	30	40	40	50	50	50
D	50	50	75	100	100	150
E	35	50	50	75	75	75

POSTED SPEED IS EXISTING SPEED LIMIT (km/h)

A - TAPER LANE WHEN NO LANE CONTROL PRESENT

B - MAX. DELINEATOR SPACING IN TAPER/WORK ZONE

C - TRAFFIC CONTROL PERSON SETBACK (m)

D - DISTANCE BETWEEN CONSTRUCTION SIGNS

E - BUFFER AREA LENGTH BETWEEN TAPER AND WORK ZONE

NOTES

1. ADVANCE VEHICLE OR TC-8 STAND-ALONE FLASHING ARROW BOARD IS NOT REQUIRED FOR REGULAR POSTED SPEEDS OF 60 km/h OR LOWER.
2. FLASHING ARROW BOARD (FAB) AND 360° ROTATING TOP MOUNTED BEACON SHALL BE ENGAGED TO REDIRECT DOWNSTREAM TRAFFIC AWAY FROM WORK AND CONTROL/BUFFER VEHICLES.
3. THE WORK SPACE MAY INCLUDE OTHER WORK VEHICLES. ALL WORK VEHICLES IN THE WORK SPACE (DOWNSTREAM OF THE VEHICLE WITH THE CRASH ATTENUATOR) WITH ACTIVATED FAB MUST BE IN BAR MODE.

752-36

TRAFFIC CONTROL MANUAL

2018

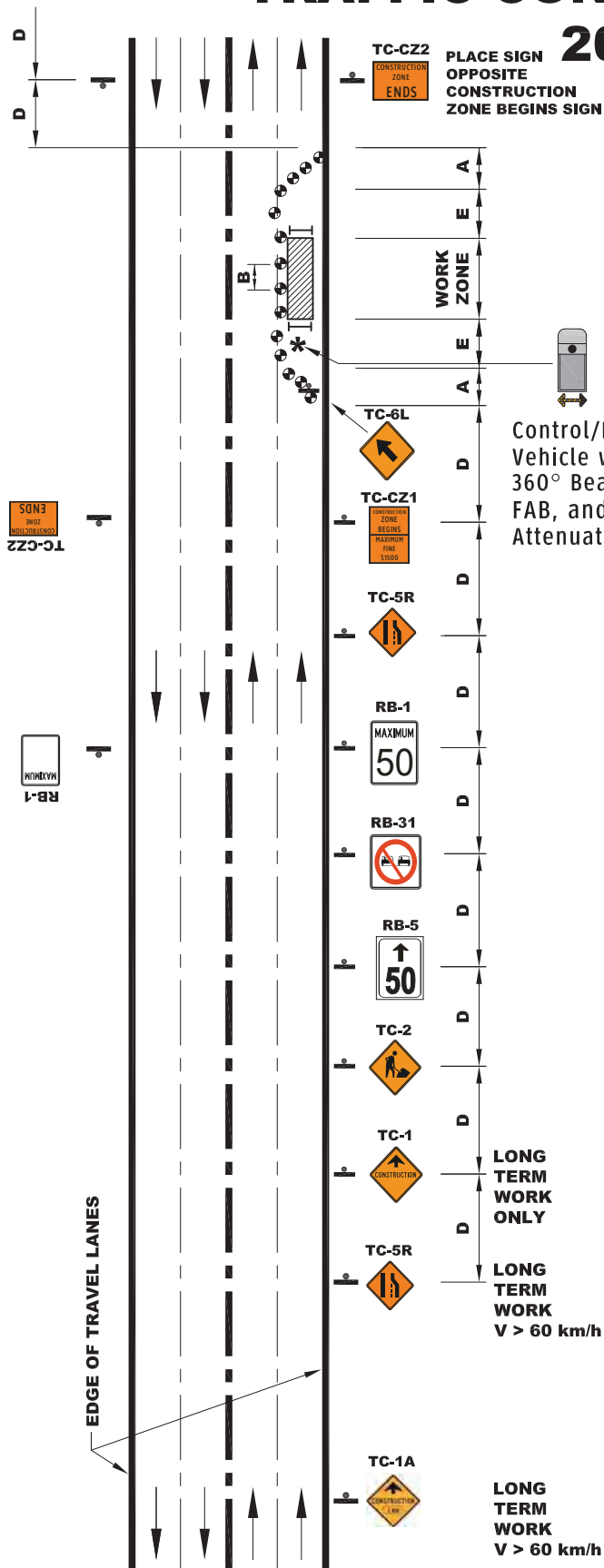

WORK ZONE DIMENSIONS FOR MULTI-LANE ROAD UNDIVIDED HIGHWAY RIGHT LANE CLOSED SHORT & LONG TERM WORK

DIMENSION (m)	NORMAL POSTED REGULATORY SPEED					
	50	60	70	80	90	100
A	30	40	60	90	110	180
B	5/8	8/12	10/15	10/15	12/18	15/20
C	30	40	40	50	50	50
D	50	50	75	100	100	150
E	35	50	50	75	75	75

POSTED SPEED IS EXISTING SPEED LIMIT (km/h)

A - TAPER LANE WHEN NO LANE CONTROL PRESENT

B - MAX. DELINEATOR SPACING IN TAPER/WORK ZONE

C - TRAFFIC CONTROL PERSON SETBACK (m)

D - DISTANCE BETWEEN CONSTRUCTION SIGNS

E - BUFFER AREA LENGTH BETWEEN TAPER AND WORK ZONE

NOTES

- WHERE THE EXISTING SPEED LIMIT IS 50 km/h OR LESS, SPEED SIGNS ARE NOT REQUIRED. REDUCE POSTED SPEED IF HAZARD ASSESSMENT INDICATES SPEED REDUCTION REQUIRED.
- CONES OR DELINEATOR POSTS MAY BE SUBSTITUTED WITH DRUMS.
- SIGN OPPOSITE APPROACH IN SAME MANNER EXCEPT ELIMINATE SIGN TC-5R.
- THE WORK SPACE MAY INCLUDE OTHER WORK VEHICLES. ALL WORK VEHICLES IN THE WORK SPACE (DOWNSTREAM OF THE VEHICLE WITH THE CRASH ATTENUATOR) WITH ACTIVATED FAB MUST BE IN BAR MODE.

752-37

TRAFFIC CONTROL MANUAL 2018

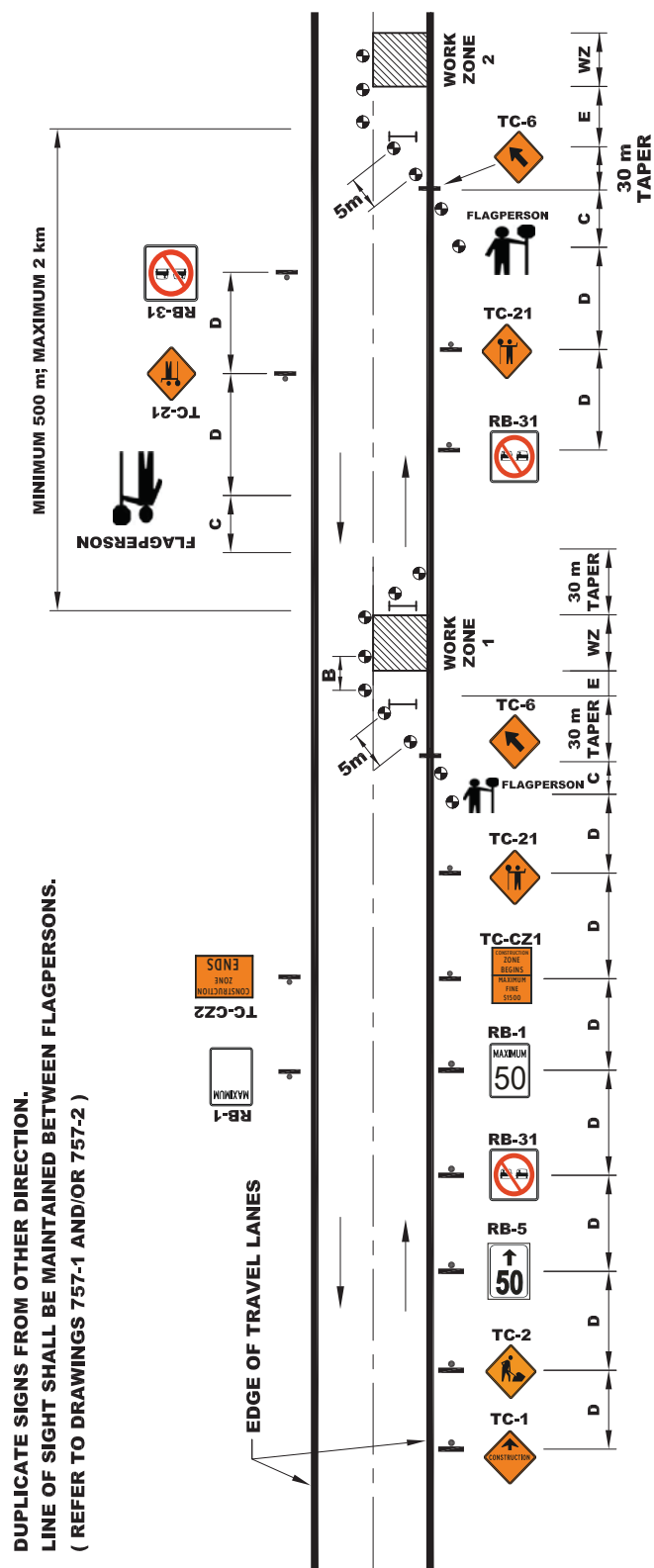

DUPLICATE SIGNS FROM OTHER DIRECTION.
 LINE OF SIGHT SHALL BE MAINTAINED BETWEEN FLAGPERSONS.
 (REFER TO DRAWINGS 757-1 AND/OR 757-2)

WORK ZONE DIMENSIONS FOR SUCCESSIVE WORK AREAS WITH ONE LANE CLOSED IN TWO WAY TRAFFIC FLAGPERSON CONTROL						
DIMENSION (m)	NORMAL POSTED REGULATORY SPEED					
	50	60	70	80	90	100
A	30	40	60	90	110	180
B	5/8	5/12	5/15	5/15	5/18	5/20
C	30	40	40	50	50	50
D	50	50	75	100	100	150
E	35	50	50	75	75	75

- POSTED SPEED IS EXISTING SPEED LIMIT (km/h)
- A - TAPER LANE WHEN NO LANE CONTROL PRESENT
 - B - MAX. DELINEATOR SPACING IN TAPER/WORK ZONE
 - C - TRAFFIC CONTROL PERSON SETBACK (m)
 - D - DISTANCE BETWEEN CONSTRUCTION SIGNS
 - E - BUFFER AREA LENGTH BETWEEN TAPER AND WORK ZONE

NOTES

1. THIS LAYOUT APPLIES WHEN THE DISTANCE BETWEEN SUCCESSIVE WORK AREAS IS OVER 500 m BUT LESS THAN 2 km, THE ENTIRE OPERATION SHALL BE CONSIDERED AS A SINGLE WORK AREA. WHEN THE DISTANCE BETWEEN WORK AREAS IS 2 km OR GREATER, THEY SHALL BE CONSIDERED AS SEPARATE WORK AREAS, AND SIGNED WITH ALL APPROACH SIGNING AS INDIVIDUAL WORK AREAS.

753-1

TRAFFIC CONTROL MANUAL 2018

WORK ZONE DIMENSIONS FOR SUCCESSIVE WORK AREAS IN SLOW MOVING OPERATIONS WITH STATIONARY PERIODS IN TWO WAY TRAFFIC WITH FLAGPERSON CONTROL

DIMENSION (m)	NORMAL POSTED REGULATORY SPEED					
	50	60	70	80	90	100
A	30	40	60	90	110	180
B	5/8	5/12	5/15	5/15	5/18	5/20
C	30	40	40	50	50	50
D	50	50	75	100	100	150
E	35	50	50	75	75	75

POSTED SPEED IS EXISTING SPEED LIMIT (km/h)

A - TAPER LANE WHEN NO LANE CONTROL PRESENT

B - MAX. DELINEATOR SPACING IN TAPER/WORK ZONE

C - TRAFFIC CONTROL PERSON SETBACK (m)

D - DISTANCE BETWEEN CONSTRUCTION SIGNS

E - BUFFER AREA LENGTH BETWEEN TAPER AND WORK ZONE

NOTES

1. THIS LAYOUT APPLIES WHEN THE DISTANCE BETWEEN SUCCESSIVE WORK AREAS IS OVER 500 m BUT LESS THAN 2 km, THE ENTIRE OPERATION SHALL BE CONSIDERED AS A SINGLE WORK AREA. WHEN THE DISTANCE BETWEEN WORK AREAS IS 2 km OR GREATER, THEY SHALL BE CONSIDERED AS SEPARATE WORK AREAS, AND SIGNED WITH ALL APPROACH SIGNING AS INDIVIDUAL WORK AREAS.
2. TRAFFIC CONES SHALL BE USED TO DELINEATE A STATIONARY WORK AREA OF UP TO 30 MINUTES (ON LOW TRAFFIC VOLUME ROADS WITH REGULAR POSTED SPEED LIMIT BELOW 70 km/h TRAFFIC CONES ARE NOT REQUIRED). TRAFFIC CONES MAY BE SUBSTITUTED WITH A CONTROL/BUFFER VEHICLE WITH 360° BEACON AND FLASHING ARROW BOARD. CONTROL/BUFFER VEHICLE MUST BE POSITIONED DISTANCE "E" FROM THE WORK ZONE. FLAGPERSON MUST BE POSITIONED DISTANCE "C" FROM THE CONTROL/BUFFER VEHICLE, IF USED.
3. CONES OR DELINEATOR POSTS MAY BE SUBSTITUTED WITH DRUMS.
4. USE TCM 752-1 OR 752-2 FOR A SINGLE STATIONARY WORK AREA AS APPROPRIATE.

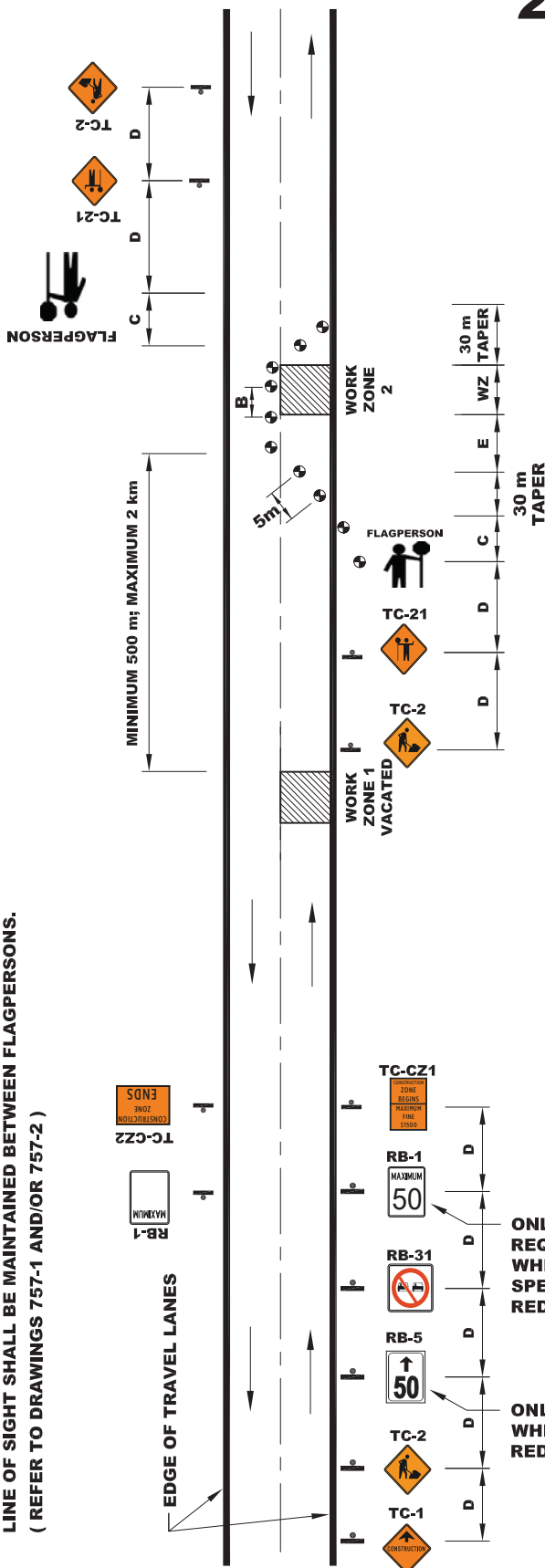

DUPLICATE SIGNS FROM OTHER DIRECTION.
LINE OF SIGHT SHALL BE MAINTAINED BETWEEN FLAGPERSONS.
(REFER TO DRAWINGS 757-1 AND/OR 757-2)

753-2

TRAFFIC CONTROL MANUAL

2018

WORK ZONE DIMENSIONS FOR ROADSIDE DIVERSION TWO-WAY TRAFFIC ON SHOULDER FOR SHORT OR LONG DURATION UNDIVIDED ROADWAY

DIMENSION (m)	NORMAL POSTED REGULATORY SPEED					
	50	60	70	80	90	100
A	30	40	60	90	110	180
B	5/8	8/12	10/15	10/15	12/18	15/20
C	30	40	40	50	50	50
D	50	50	75	100	100	150
E	35	50	50	75	75	75

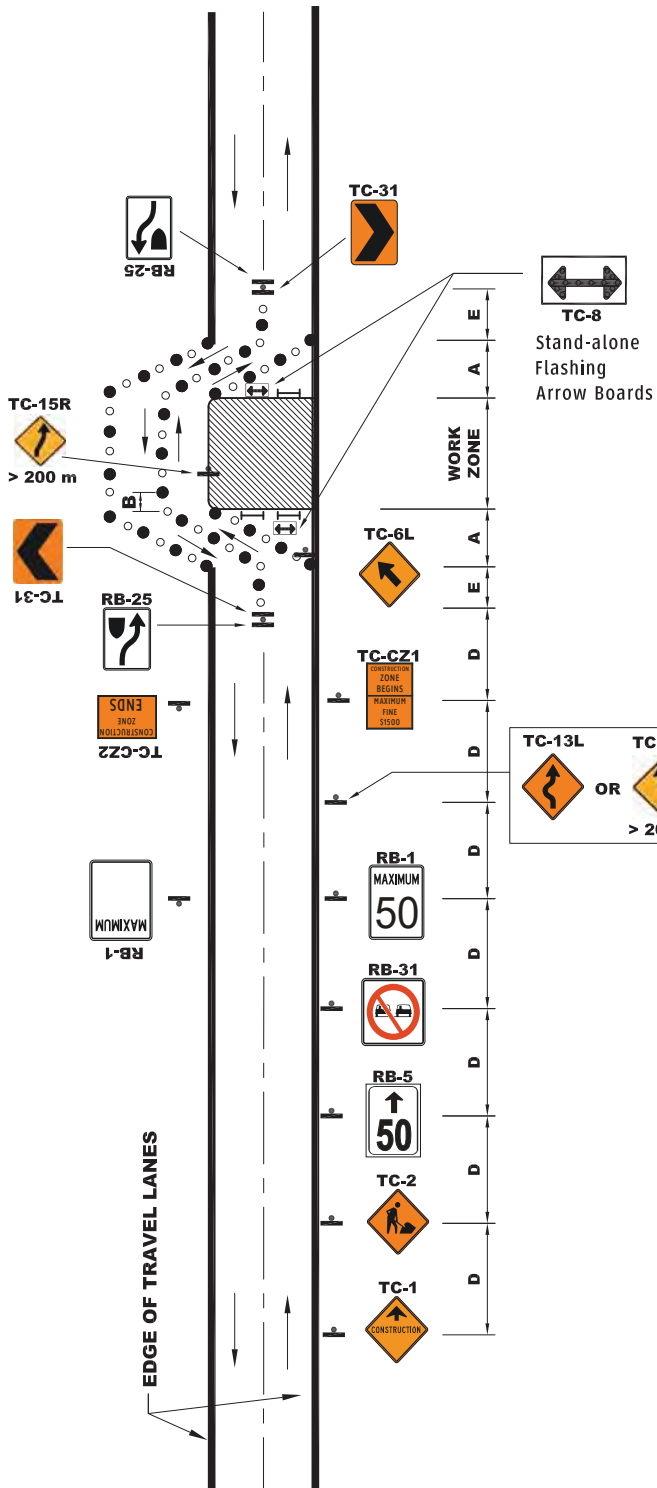

POSTED SPEED IS EXISTING SPEED LIMIT (km/h)

A - TAPER LANE WHEN NO LANE CONTROL PRESENT

B - MAX. DELINEATOR SPACING IN TAPER/WORK ZONE

C - TRAFFIC CONTROL PERSON SETBACK (m)

D - DISTANCE BETWEEN CONSTRUCTION SIGNS

E - BUFFER AREA LENGTH BETWEEN TAPER AND WORK ZONE

NOTES

- SIGN OPPOSITE APPROACH IN THE SAME MANNER BUT CHANGE TC-13L TO TC-13R.
- WHERE A FLAGPERSON IS PRESENT FOR THIS OPERATION SIGN AS PER FORM 752-1 OR 752-2 AS APPROPRIATE.
- TC-8 MAY BE REPLACED WITH A CONTROL VEHICLE WITH FAB FOR SHORT DURATION
- CONES OR DELINEATOR POSTS MAY BE SUBSTITUTED WITH DRUMS.
- WHERE THE REGULAR EXISTING SPEED LIMIT IS 50 km/h OR LESS, SPEED SIGNS ARE NOT REQUIRED. REDUCE POSTED SPEED IF HAZARD ASSESSMENT INDICATES SPEED REDUCTION REQUIRED.
- USE SIGN TC-15L AND SIGN TC-15R IN PLACE OF SIGN TC-13L IF LENGTH OF DETOUR EXCEEDS 200 METERS. SIGN TC-13L IS APPROPRIATE FOR DETOURS LESS THAN OR EQUAL TO 200 METERS.
- TC-8 MAY BE REPLACED WITH A CONTROL VEHICLE WITH FAB FOR SHORT DURATION

754-1



TRANSPORTATION AND WORKS
HIGHWAY DESIGN DIVISION

ROADSIDE DIVERSION TWO-WAY TRAFFIC ON SHOULDER FOR SHORT OR LONG DURATION UNDIVIDED

DRAWN BY: G. CLARKE

DATE: Rev June 2018

NOT TO SCALE

TRAFFIC CONTROL MANUAL

2018

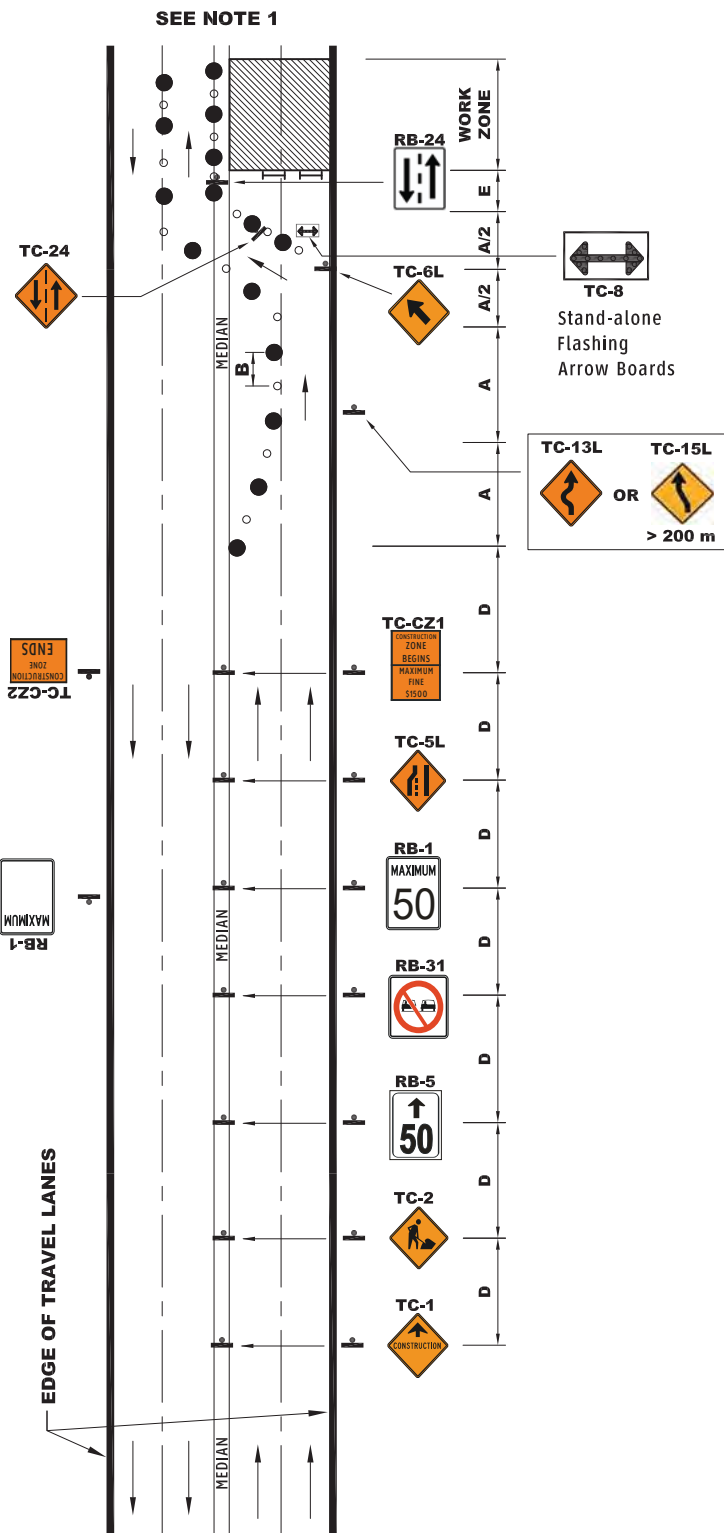

WORK ZONE DIMENSIONS FOR ROADSIDE DIVERSION DIVIDED HIGHWAY PART "A" FOR SHORT OR LONG DURATION DIVIDED ROADWAY

DIMENSION (m)	NORMAL POSTED REGULATORY SPEED					
	50	60	70	80	90	100
A	30	40	60	90	110	180
B	5/8	8/12	10/15	10/15	12/18	15/20
C	30	40	40	50	50	50
D	50	50	75	100	100	150
E	35	50	50	75	75	75

POSTED SPEED IS EXISTING SPEED LIMIT (km/h)

A - TAPER LANE WHEN NO LANE CONTROL PRESENT

B - MAX. DELINEATOR SPACING IN TAPER/WORK ZONE

C - TRAFFIC CONTROL PERSON SETBACK (m)

D - DISTANCE BETWEEN CONSTRUCTION SIGNS

E - BUFFER AREA LENGTH BETWEEN TAPER AND WORK ZONE

NOTES

- SIGN OPPOSITE APPROACH AS SHOWN IN FIGURE 754-3.
- NON-APPLICABLE PAVEMENT MARKINGS SHALL BE REMOVED FOR LONG DURATION WORK.
- FOR LONG TERM DIVERSIONS OF LONG DISTANCE INSTALL TWO-WAY TRAFFIC SIGN (RB-24 OR TC-24) AND DO NOT PASS SIGNS WITH DO NOT PASS TAB (RB-31 & RB-31T) ALTERNATELY EVERY 0.5 km OF DIVERSION.
- POSTED SPEED SHALL BE BASED ON HIGHWAY ALIGNMENT LIMITATIONS.
- WHERE THE REGULAR EXISTING SPEED LIMIT IS 50 km/h OR LESS, SPEED SIGNS ARE NOT REQUIRED. REDUCE POSTED SPEED IF HAZARD ASSESSMENT INDICATES SPEED REDUCTION REQUIRED.
- CONES OR DELINEATOR POSTS MAY BE SUBSTITUTED WITH DRUMS.
- USE SIGN TC-15L AND SIGN TC-15R IN PLACE OF SIGN TC-13L IF LENGTH OF DETOUR EXCEEDS 200 METERS. SIGN TC-13L IS APPROPRIATE FOR DETOURS LESS THAN OR EQUAL TO 200 METERS.
- TC-8 MAY BE REPLACED WITH A CONTROL VEHICLE WITH FAB FOR SHORT DURATION

754-2



TRANSPORTATION AND WORKS
HIGHWAY DESIGN DIVISION

ROADSIDE DIVERSION PART "A" ACROSS MEDIAN FOR SHORT OR LONG DURATION DIVIDED HIGHWAY

DRAWN BY: G. CLARKE

DATE: Rev June 2018

NOT TO SCALE

TRAFFIC CONTROL MANUAL

2018

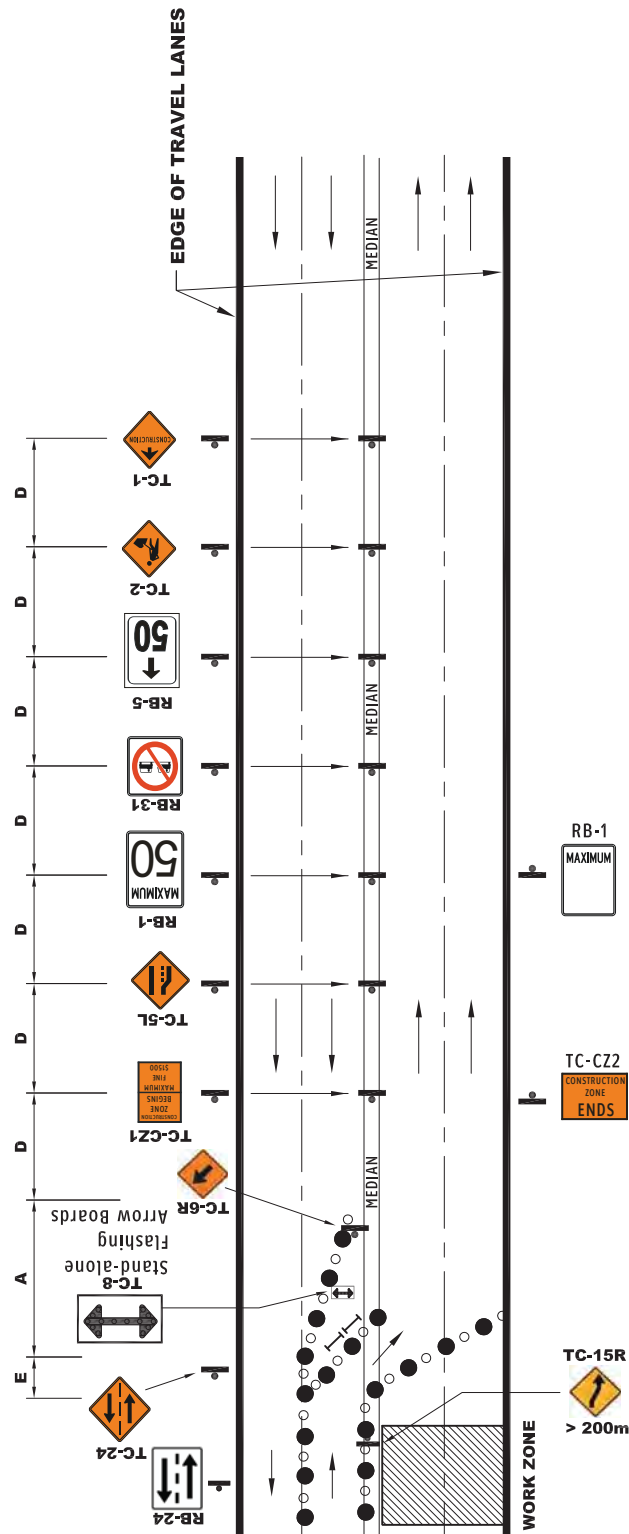

SEE NOTE 1

WORK ZONE DIMENSIONS FOR ROADSIDE DIVERSION DIVIDED HIGHWAY PART "B" FOR SHORT OR LONG DURATION DIVIDED ROADWAY

DIMENSION (m)	NORMAL POSTED REGULATORY SPEED					
	50	60	70	80	90	100
A	30	40	60	90	110	180
B	5/8	8/12	10/15	10/15	12/18	15/20
C	30	40	40	50	50	50
D	50	50	75	100	100	150
E	35	50	50	75	75	75

POSTED SPEED IS EXISTING SPEED LIMIT (km/h)

- A - TAPER LANE WHEN NO LANE CONTROL PRESENT
- B - MAX. DELINEATOR SPACING IN TAPER/WORK ZONE
- C - TRAFFIC CONTROL PERSON SETBACK (m)
- D - DISTANCE BETWEEN CONSTRUCTION SIGNS
- E - BUFFER AREA LENGTH BETWEEN TAPER AND WORK ZONE

NOTES

1. SIGN OPPOSITE APPROACH AS SHOWN IN FIGURE 754-2.
2. NON-APPLICABLE PAVEMENT MARKINGS SHALL BE REMOVED FOR LONG DURATION WORK.
3. FOR LONG TERM DIVERSIONS OF LONG DISTANCE INSTALL TWO-WAY TRAFFIC SIGN (RB-24 OR TC-24) AND DO NOT PASS SIGNS WITH DO NOT PASS TAB (RB-31 & RB-31T) ALTERNATELY EVERY 0.5 km OF DIVERSION.
4. POSTED SPEED SHALL BE BASED ON HIGHWAY ALIGNMENT LIMITATIONS.
5. CONES OR DELINEATOR POSTS MAY BE SUBSTITUTED WITH DRUMS.
6. USE SIGN TC-15L AND SIGN TC-15R IN PLACE OF SIGN TC-13L IF LENGTH OF DETOUR EXCEEDS 200 METERS. SIGN TC-13L IS APPROPRIATE FOR DETOURS LESS THAN OR EQUAL TO 200 METERS.
7. TC-8 MAY BE REPLACED WITH A CONTROL VEHICLE WITH FAB FOR SHORT DURATION

754-3



TRANSPORTATION AND WORKS
HIGHWAY DESIGN DIVISION

ROADSIDE DIVERSION PART "B" ACROSS MEDIAN FOR SHORT OR LONG DURATION DIVIDED HIGHWAY

DRAWN BY: G. CLARKE

DATE: Rev June 2018

NOT TO SCALE

TRAFFIC CONTROL MANUAL 2018

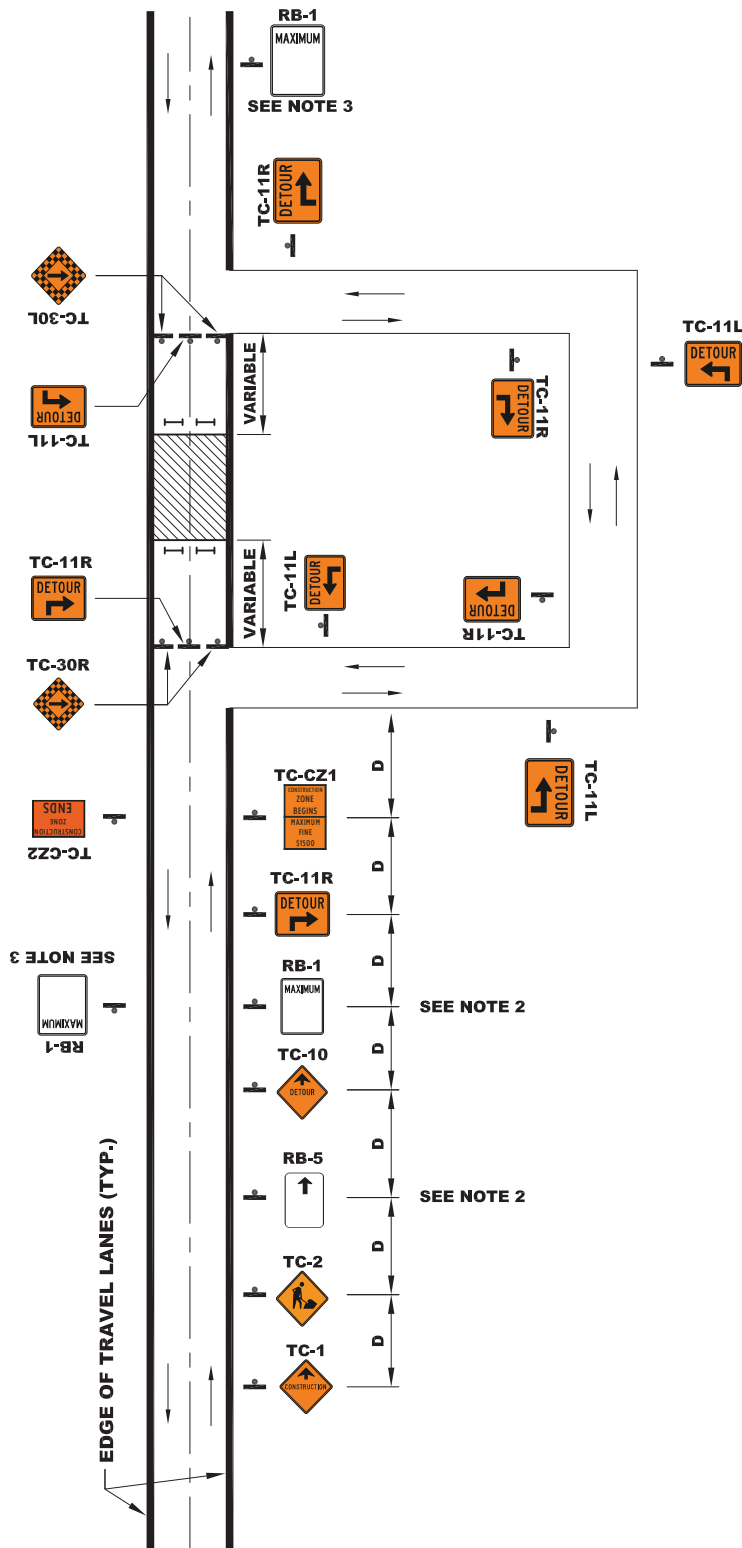

**WORK ZONE DIMENSIONS FOR
DETOUR TO ALTERNATE ROAD
AVAILABLE FOR DETOUR
SHORT TERM WORK
UNDIVIDED ROADWAY**

DIMENSION (m)	NORMAL POSTED REGULATORY SPEED					
	50	60	70	80	90	100
A	30	40	60	90	110	180
B	5/8	8/12	10/15	10/15	12/18	15/20
C	30	40	40	50	50	50
D	50	50	75	100	100	150
E	35	50	50	75	75	75

- POSTED SPEED IS EXISTING SPEED LIMIT (km/h)**
- A** - TAPER LANE WHEN NO LANE CONTROL PRESENT
 - B** - MAX. DELINEATOR SPACING IN TAPER/WORK ZONE
 - C** - TRAFFIC CONTROL PERSON SETBACK (m)
 - D** - DISTANCE BETWEEN CONSTRUCTION SIGNS
 - E** - BUFFER AREA LENGTH BETWEEN TAPER AND WORK ZONE

NOTES

1. SIGN OPPOSITE APPROACH IN THE SAME MANNER.
2. POSTED SPEED SHALL BE BASED ON DETOUR ROAD ALIGNMENT LIMITATIONS.
3. POST NORMAL SPEED LIMIT AT END OF DETOUR.

755-1



TRANSPORTATION AND WORKS
HIGHWAY DESIGN DIVISION

**DETOUR TO ALTERNATE ROADS AVAILABLE
FOR DETOUR - SHORT TERM WORK
UNDIVIDED ROADWAY**

DRAWN BY: G. CLARKE

DATE: Rev November 2018 NOT TO SCALE

TRAFFIC CONTROL MANUAL 2018

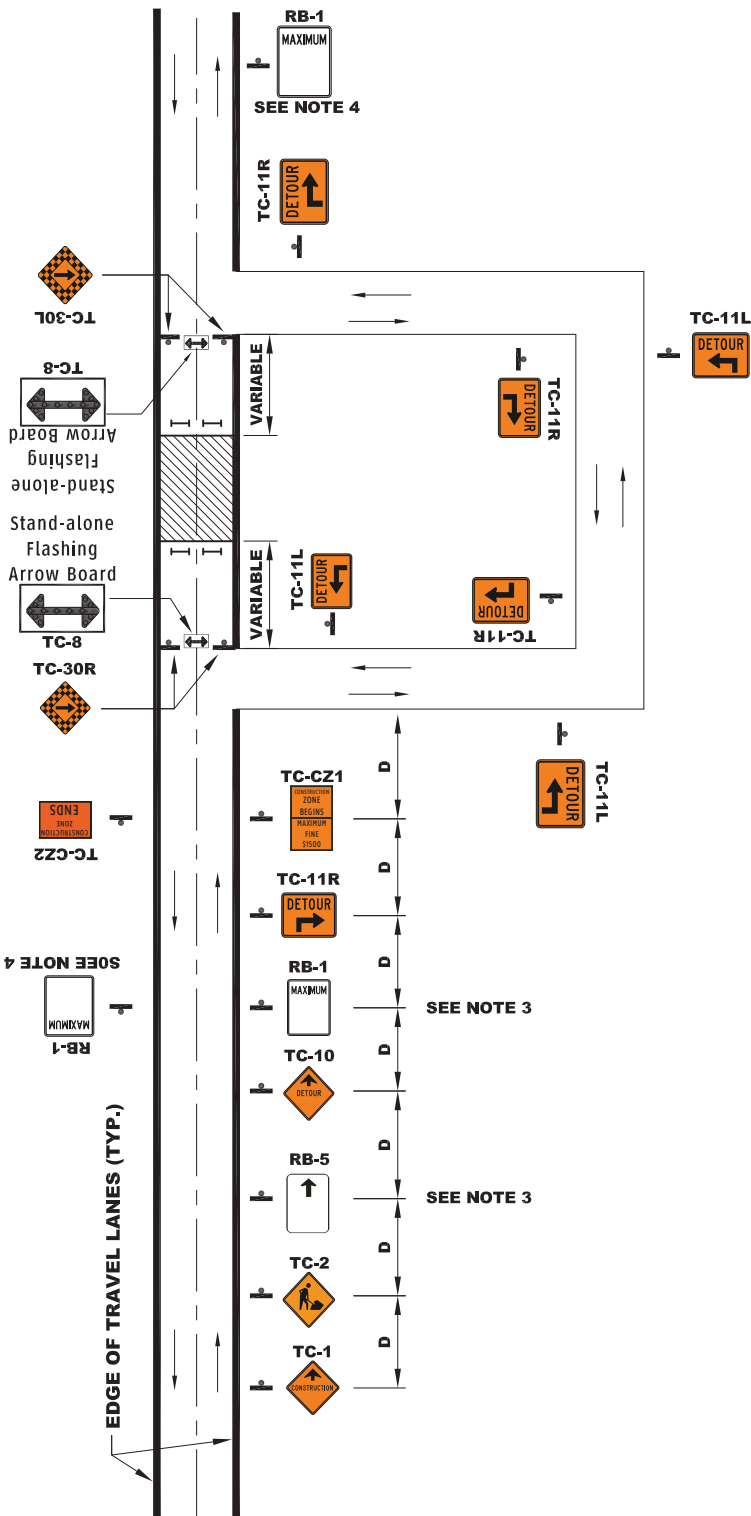

WORK ZONE DIMENSIONS FOR DETOUR TO ALTERNATE ROAD AVAILABLE FOR DETOUR LONG TERM WORK UNDIVIDED ROADWAY

DIMENSION (m)	NORMAL POSTED REGULATORY SPEED					
	50	60	70	80	90	100
A	30	40	60	90	110	180
B	5/8	8/12	10/15	10/15	12/18	15/20
C	30	40	40	50	50	50
D	50	50	75	100	100	150
E	35	50	50	75	75	75

POSTED SPEED IS EXISTING SPEED LIMIT (km/h)

- A - TAPER LANE WHEN NO LANE CONTROL PRESENT**
- B - MAX. DELINEATOR SPACING IN TAPER/WORK ZONE**
- C - TRAFFIC CONTROL PERSON SETBACK (m)**
- D - DISTANCE BETWEEN CONSTRUCTION SIGNS**
- E - BUFFER AREA LENGTH BETWEEN TAPER AND WORK ZONE**

NOTES

- 1. SIGN OPPOSITE APPROACH AS SHOWN IN SAME MANNER.**
- 2. NON-APPLICABLE PAVEMENT MARKINGS SHALL BE REMOVED FOR LONG DURATION WORK.**
- 3. POSTED SPEED SHALL BE BASED ON DETOUR ROAD ALIGNMENT LIMITATIONS.**
- 4. POST NORMAL SPEED AT END OF DETOUR.**

755-2

TRAFFIC CONTROL MANUAL

2018

NOTE: SAME SIGNAGE IN OPPOSITE DIRECTION, BUT ELIMINATE THE TC-16R AND STAND-ALONE FAB

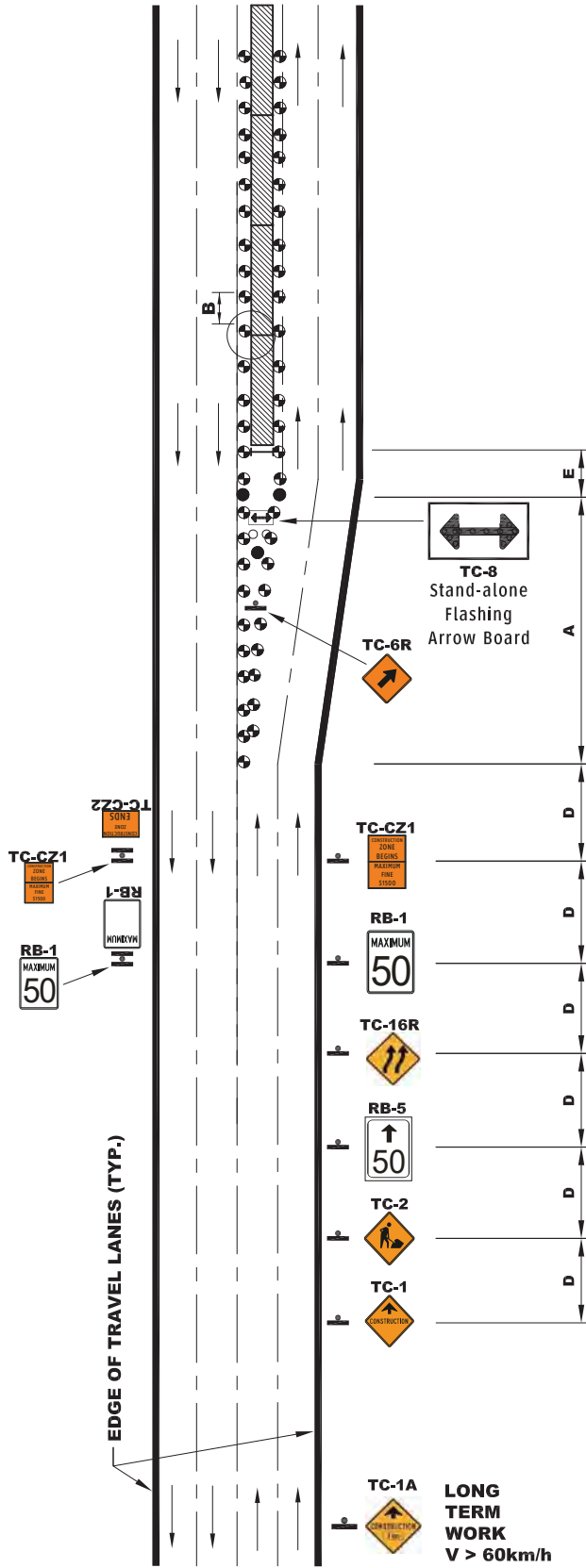

WORK ZONE DIMENSIONS FOR LANE REALIGNMENT FOR SHORT OR LONG DURATION UNDIVIDED ROADWAY

DIMENSION (m)	NORMAL POSTED REGULATORY SPEED					
	50	60	70	80	90	100
A	30	40	60	90	110	180
B	5/8	8/12	10/15	10/15	12/18	15/20
C	30	40	40	50	50	50
D	50	50	75	100	100	150
E	35	50	50	75	75	75

POSTED SPEED IS EXISTING SPEED LIMIT (km/h)

- A - TAPER LANE WHEN NO LANE CONTROL PRESENT
- B - MAX. DELINEATOR SPACING IN TAPER/WORK ZONE
- C - TRAFFIC CONTROL PERSON SETBACK (m)
- D - DISTANCE BETWEEN CONSTRUCTION SIGNS
- E - BUFFER AREA LENGTH BETWEEN TAPER AND WORK ZONE

NOTES

1. NON-APPLICABLE PAVEMENT MARKINGS SHALL BE REMOVED FOR LONG DURATION WORK.
2. POSTED SPEED SHALL BE BASED ON HIGHWAY ALIGNMENT LIMITATIONS.
3. CONES OR DELINEATOR POSTS MAY BE SUBSTITUTED WITH DRUMS.
4. POST NORMAL SPEED LIMIT AT END OF LANE REALIGNMENT.
5. TC-8 MAY BE REPLACED WITH A CONTROL VEHICLE WITH FAB FOR SHORT DURATION

755-3



TRANSPORTATION AND WORKS
HIGHWAY DESIGN DIVISION

LANE REALIGNMENT FOR SHORT OR LONG DURATION UNDIVIDED HIGHWAY

DRAWN BY: G. CLARKE DATE: Rev November 2018 NOT TO SCALE

TRAFFIC CONTROL MANUAL 2018

WORK ZONE DIMENSIONS FOR INTERSECTING ROADS IN WORK AREAS SPEED LIMIT > 60km/h LONG TERM WORK

DIMENSION (m)	NORMAL POSTED REGULATORY SPEED				
	70	80	90	100	
A	60	90	110	180	
B	10/15	10/15	12/18	15/20	
C	40	50	50	50	
D	75	100	100	150	
E	50	75	75	75	

POSTED SPEED IS EXISTING SPEED LIMIT (km/h)

A - TAPER LANE WHEN NO LANE CONTROL PRESENT

B - MAX. DELINEATOR SPACING IN TAPER/WORK ZONE

C - TRAFFIC CONTROL PERSON SETBACK (m)

D - DISTANCE BETWEEN CONSTRUCTION SIGNS

E - BUFFER AREA LENGTH BETWEEN TAPER
AND WORK ZONE

NOTES

1. THIS TCM LAYOUT IS AN EXAMPLE INCLUDING TCM LAYOUT 752-1, WHERE INTERSECTING ROADS MAY EXIST WITHIN THE APPROACH SIGNAGE.
2. THE DECISION TO USE ADDITIONAL SIGNS AS REQUIRED SHOULD BE BASED ON SITE CONDITIONS, WORK ACTIVITY AND SOUND JUDGMENT.
3. SPACING BETWEEN SIGNS ARE DETERMINED BY THE CONSTRUCTION DISTANCE TABLE ABOVE AND ON DRAWING 799-1.
4. THIS TCM LAYOUT APPLIES TO LONG TERM WORK SITUATIONS. THE SIGNING OF INTERSECTING ROADS FOR SHORT TERM WORK AND VERY SHORT TERM WORK SITUATIONS SHOULD BE DETERMINED USING SOUND JUDGMENT AND OTHER SIMILAR TCM LAYOUTS FOR THOSE CONDITIONS.
5. REDUCE POSTED SPEED IF HAZARD ASSESSMENT INDICATES SPEED REDUCTION REQUIRED.

756-1

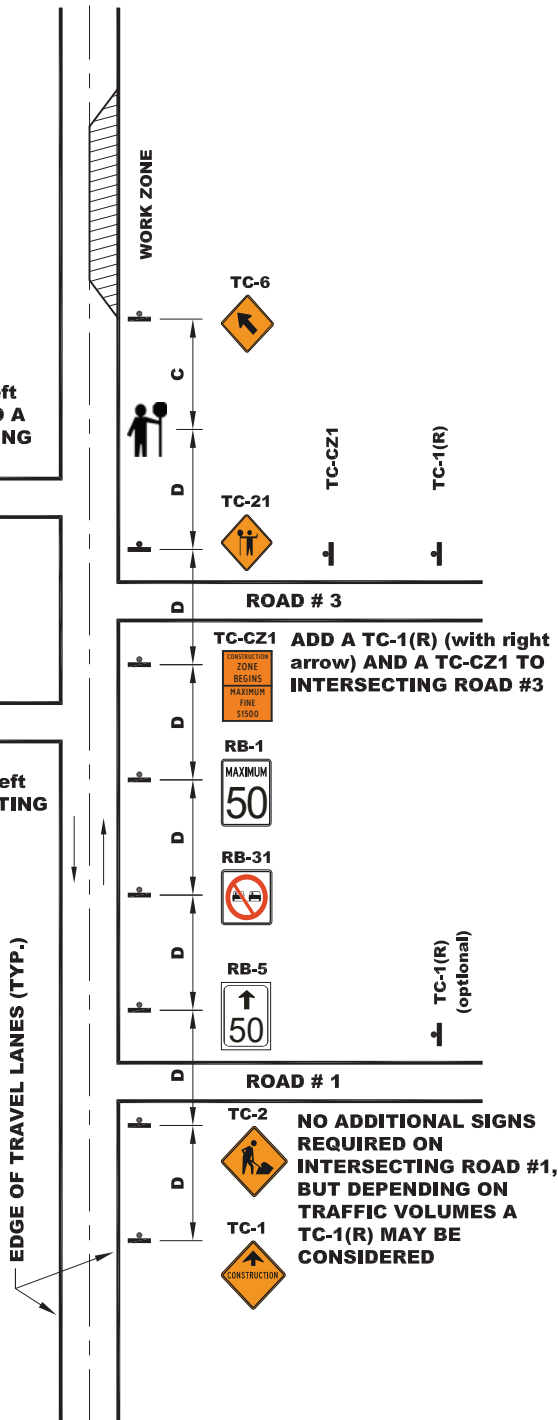

TRAFFIC CONTROL MANUAL

2018

WORK ZONE DIMENSIONS FOR INTERSECTING ROADS IN WORK AREAS SPEED LIMIT ≤ 60km/h LONG TERM WORK

DIMENSION (m)	NORMAL POSTED REGULATORY SPEED				
	50	60			
A	30	40			
B	5/8	8/12			
C	30	40			
D	50	50			
E	35	50			

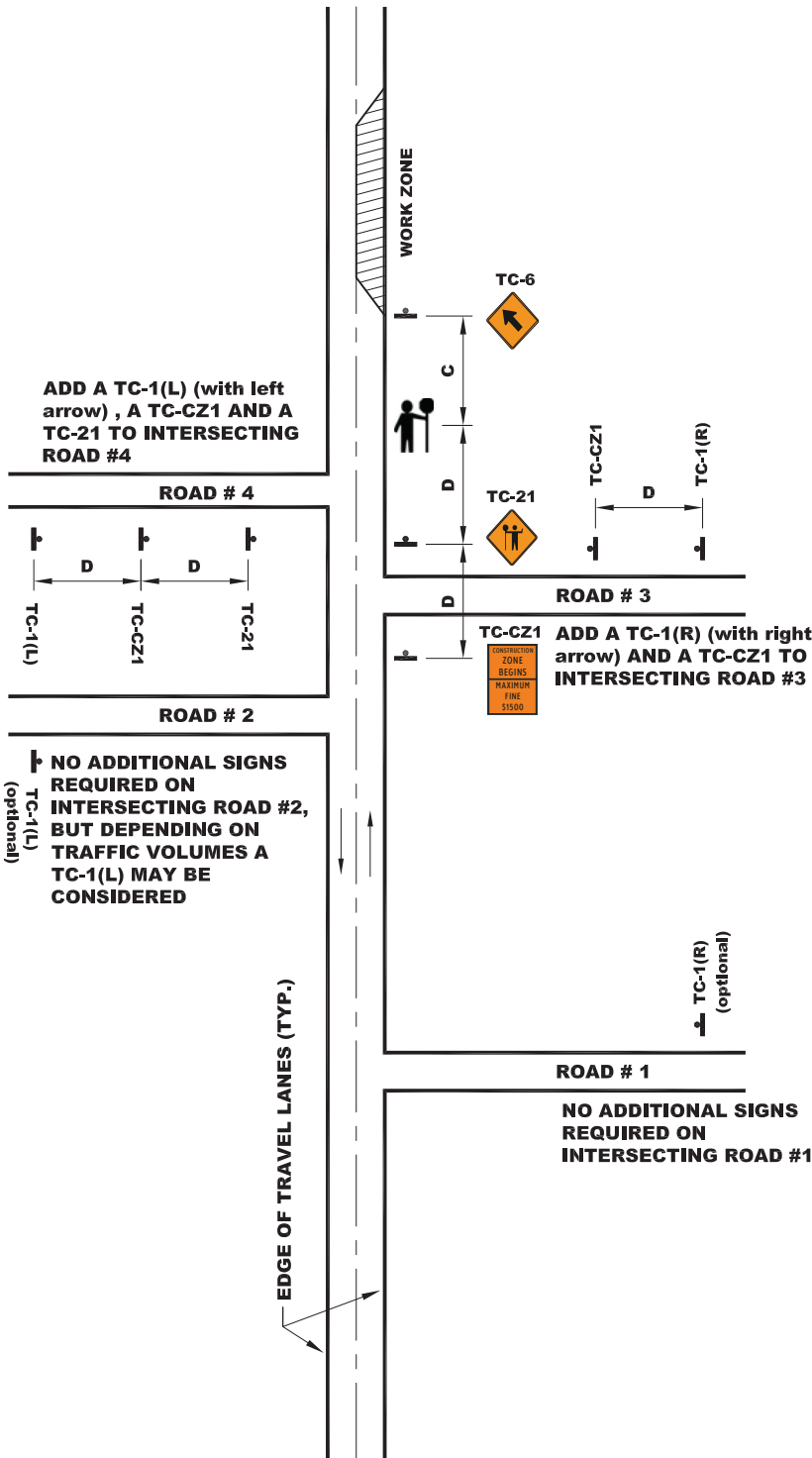

- POSTED SPEED IS EXISTING SPEED LIMIT (km/h)**
- A - TAPER LANE WHEN NO LANE CONTROL PRESENT**
 - B - MAX. DELINEATOR SPACING IN TAPER/WORK ZONE**
 - C - TRAFFIC CONTROL PERSON SETBACK (m)**
 - D - DISTANCE BETWEEN CONSTRUCTION SIGNS**
 - E - BUFFER AREA LENGTH BETWEEN TAPER AND WORK ZONE**

NOTES

1. THIS TCM LAYOUT IS AN EXAMPLE INCLUDING TCM LAYOUT 752-1, WHERE INTERSECTING ROADS MAY EXIST WITHIN THE APPROACH SIGNAGE.
2. THE DECISION TO USE ADDITIONAL SIGNS AS REQUIRED SHOULD BE BASED ON SITE CONDITIONS, WORK ACTIVITY AND SOUND JUDGMENT.
3. SPACING BETWEEN SIGNS ARE DETERMINED BY THE CONSTRUCTION DISTANCE TABLE ABOVE AND ON DRAWING 799-1.
4. THIS TCM LAYOUT APPLIES TO LONG TERM WORK SITUATIONS. THE SIGNING OF INTERSECTING ROADS FOR SHORT TERM WORK AND VERY SHORT TERM WORK SITUATIONS SHOULD BE DETERMINED USING SOUND JUDGMENT AND OTHER SIMILAR TCM LAYOUTS FOR THOSE CONDITIONS.
5. REDUCE POSTED SPEED IF HAZARD ASSESSMENT INDICATES SPEED REDUCTION REQUIRED.

756-2

TRAFFIC CONTROL MANUAL 2018

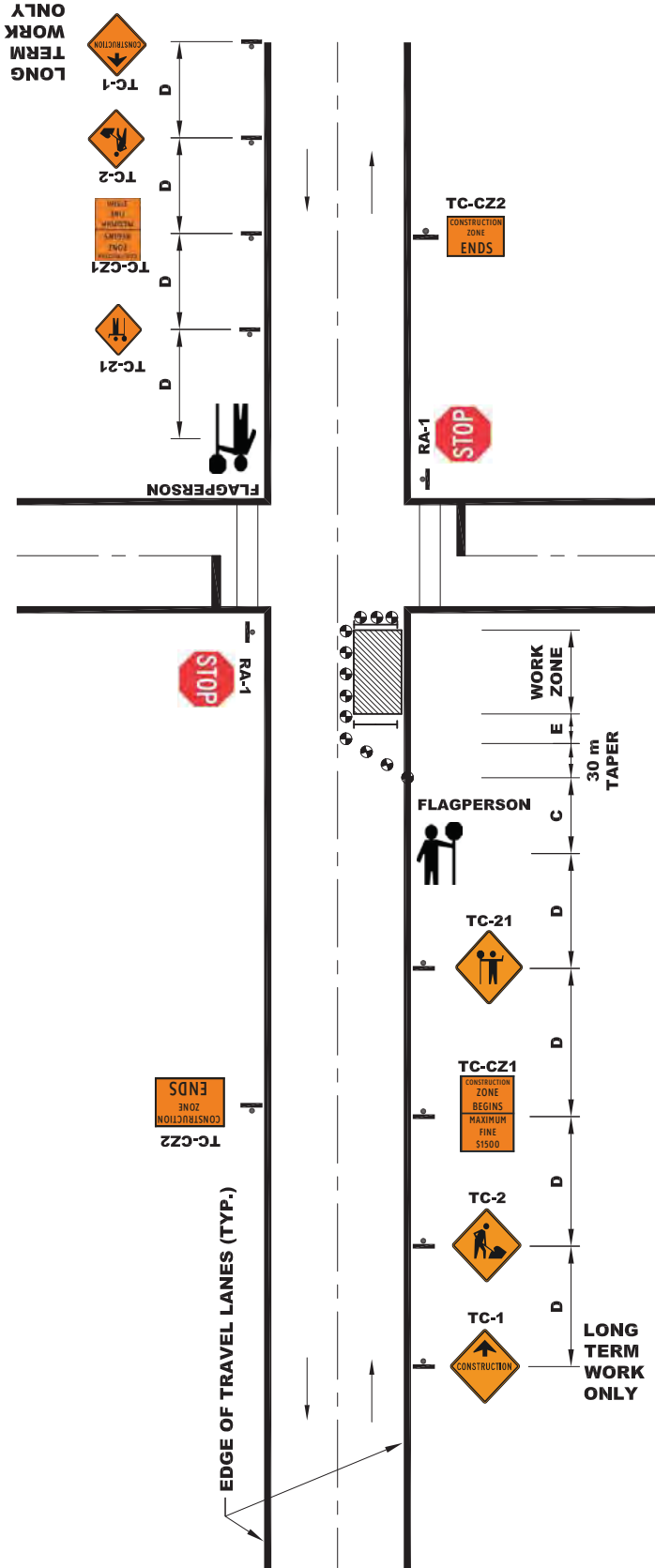

WORK ZONE DIMENSIONS FOR INTERSECTING ROADS IN WORK AREAS NEAR-SIDE OF INTERSECTION LANE CLOSED FLAGPERSON CONTROLLED UNDIVIDED						
DIMENSION (m)	NORMAL POSTED REGULATORY SPEED					
	50	60	70	80	90	100
A	30	40	60	90	110	180
B	5/8	8/12	10/15	10/15	12/18	15/20
C	30	40	40	50	50	50
D	50	50	75	100	100	150
E	35	50	50	75	75	75

POSTED SPEED IS EXISTING SPEED LIMIT (km/h)

- A - TAPER LANE WHEN NO LANE CONTROL PRESENT
- B - MAX. DELINEATOR SPACING IN TAPER/WORK ZONE
- C - TRAFFIC CONTROL PERSON SETBACK (m)
- D - DISTANCE BETWEEN CONSTRUCTION SIGNS
- E - BUFFER AREA LENGTH BETWEEN TAPER AND WORK ZONE

NOTES

1. THIS TCM LAYOUT IS AN EXAMPLE INCLUDING TCM LAYOUT 752-2, WHERE INTERSECTING ROADS MAY EXIST WITHIN THE APPROACH SIGNAGE.
2. THE DECISION TO USE ADDITIONAL SIGNS AS REQUIRED SHOULD BE BASED ON SITE CONDITIONS, WORK ACTIVITY AND SOUND JUDGMENT.
3. SPACING BETWEEN SIGNS ARE DETERMINED BY THE CONSTRUCTION DISTANCE TABLE ABOVE AND ON DRAWING 799-1.
4. REDUCE POSTED SPEED IF HAZARD ASSESSMENT INDICATES SPEED REDUCTION REQUIRED.
5. IF TRAFFIC LIGHTS ARE PRESENT, DEACTIVATE TRAFFIC LIGHTS AND FOLLOW FLAGPERSON REQUIREMENTS GUIDELINES.

756-3

TRAFFIC CONTROL MANUAL 2018

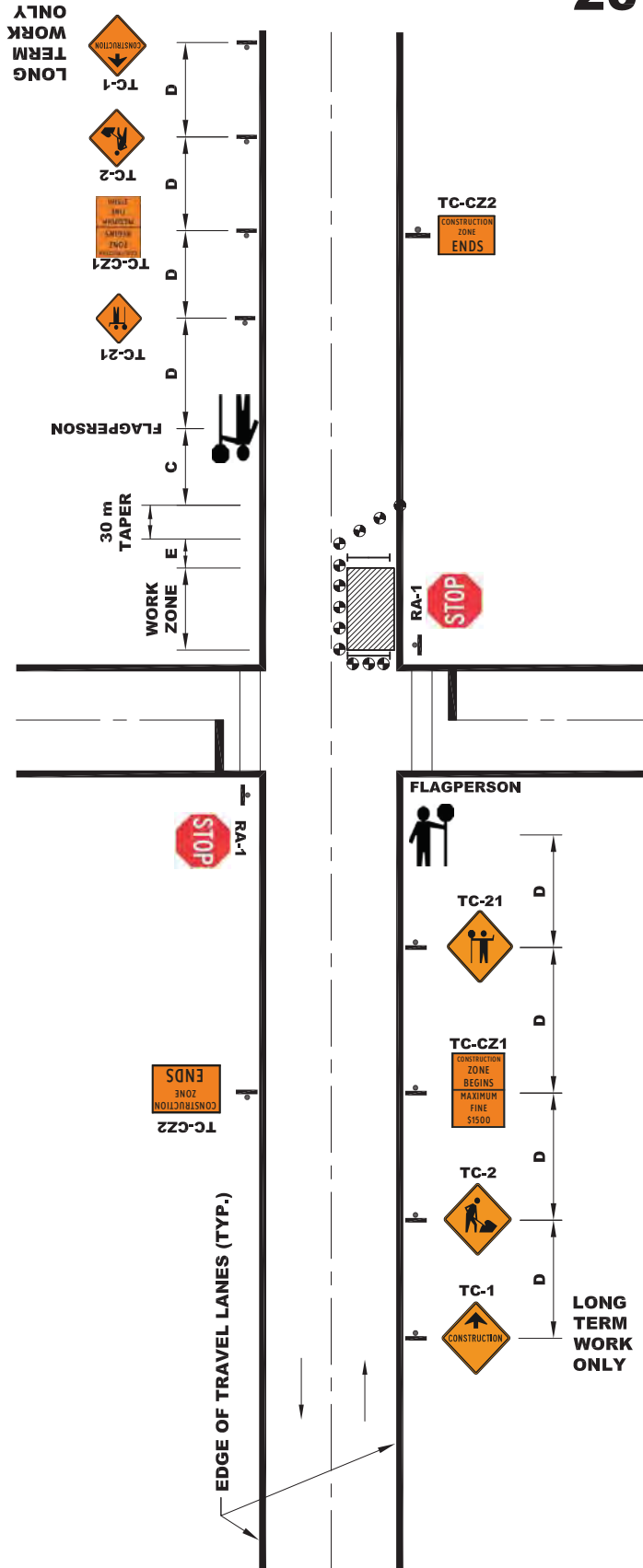

WORK ZONE DIMENSIONS FOR INTERSECTING ROADS IN WORK AREAS FAR-SIDE OF INTERSECTION LANE CLOSED FLAGPERSON CONTROLLED UNDIVIDED						
DIMENSION (m)	NORMAL POSTED REGULATORY SPEED					
	50	60	70	80	90	100
A	30	40	60	90	110	180
B	5/8	8/12	10/15	10/15	12/18	15/20
C	30	40	40	50	50	50
D	50	50	75	100	100	150
E	35	50	50	75	75	75

POSTED SPEED IS EXISTING SPEED LIMIT (km/h)

- A - TAPER LANE WHEN NO LANE CONTROL PRESENT
- B - MAX. DELINEATOR SPACING IN TAPER/WORK ZONE
- C - TRAFFIC CONTROL PERSON SETBACK (m)
- D - DISTANCE BETWEEN CONSTRUCTION SIGNS
- E - BUFFER AREA LENGTH BETWEEN TAPER AND WORK ZONE

NOTES

1. THIS TCM LAYOUT IS AN EXAMPLE INCLUDING TCM LAYOUT 752-2, WHERE INTERSECTING ROADS MAY EXIST WITHIN THE APPROACH SIGNAGE.
2. THE DECISION TO USE ADDITIONAL SIGNS AS REQUIRED SHOULD BE BASED ON SITE CONDITIONS, WORK ACTIVITY AND SOUND JUDGMENT.
3. SPACING BETWEEN SIGNS ARE DETERMINED BY THE CONSTRUCTION DISTANCE TABLE ABOVE AND ON DRAWING 799-1.
4. REDUCE POSTED SPEED IF HAZARD ASSESSMENT INDICATES SPEED REDUCTION REQUIRED.
5. IF TRAFFIC LIGHTS ARE PRESENT, DEACTIVATE TRAFFIC LIGHTS AND FOLLOW FLAGPERSON REQUIREMENTS GUIDELINES.

756-4

TRAFFIC CONTROL MANUAL

2018

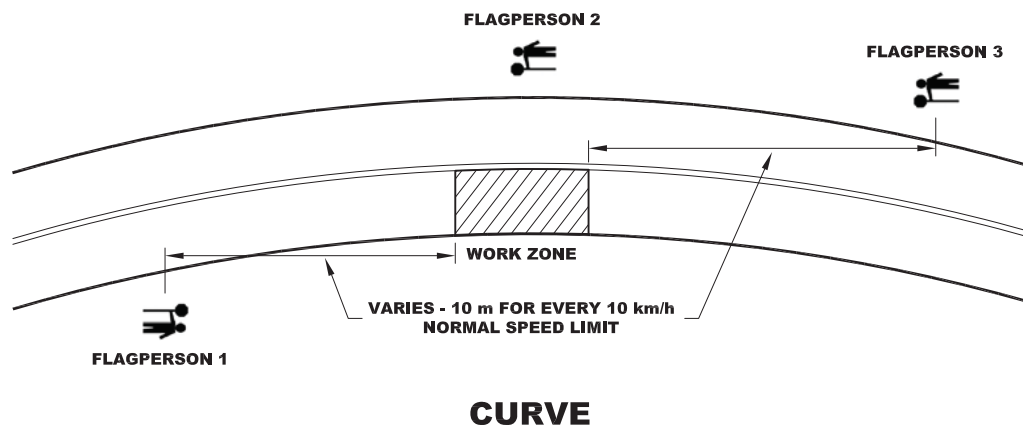
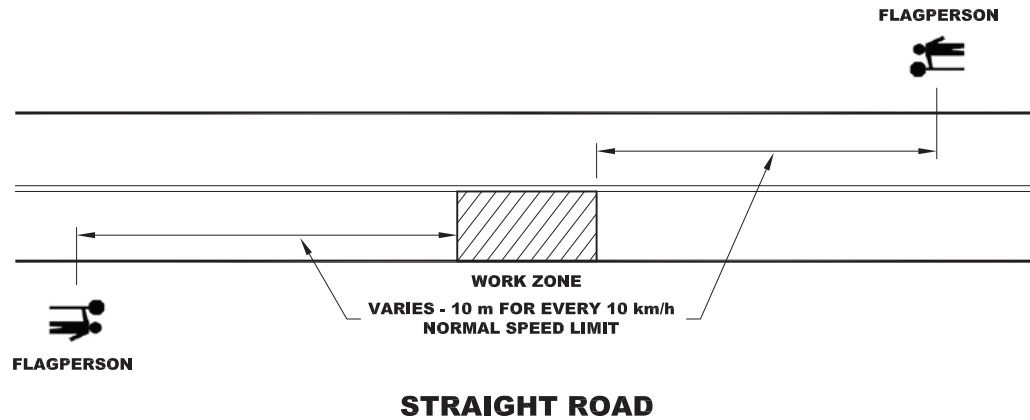

NOTES:

1. ON CURVES AND HILLS WHERE THREE FLAGPERSONS ARE REQUIRED, THE DUTY OF FLAGPERSON NUMBER 2 IS TO RELAY SIGNALS BETWEEN FLAGPERSON NUMBER 1 AND FLAGPERSON NUMBER 3.
2. LINE OF SIGHT MUST BE MAINTAINED BETWEEN TWO CONSECUTIVE FLAGPERSONS.
3. ALL FLAGPERSON ACTIVITIES SHALL NOT COMMENCE UNTIL ALL SIGNS ARE IN PLACE.
4. THE INTERMEDIATE FLAGPERSON MAY BE ELIMINATED IF PROPER ELECTRONIC COMMUNICATION IS PROVIDED TO THE FLAGPERSONS.

757-1

TRAFFIC CONTROL MANUAL

2018

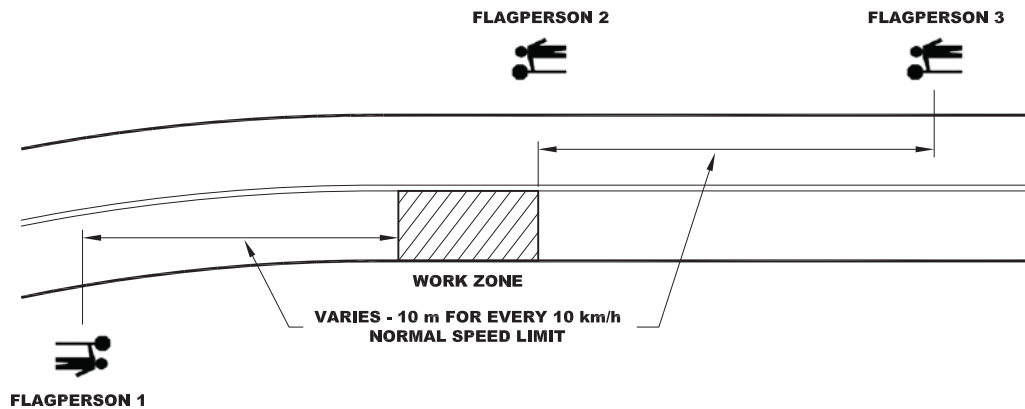

PLAN VIEW

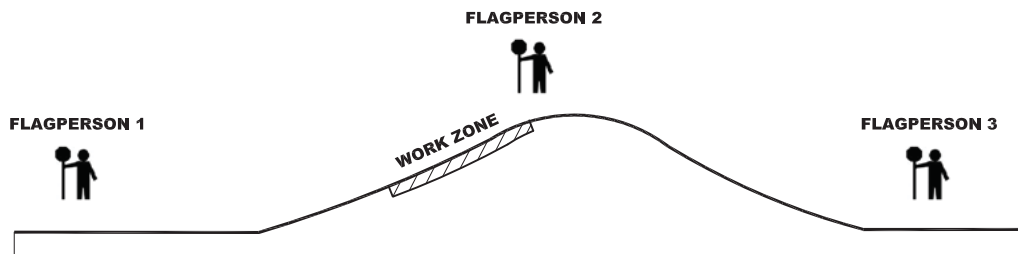

PROFILE VIEW

NOTES:

1. ON CURVES AND HILLS WHERE THREE FLAGPERSONS ARE REQUIRED, THE DUTY OF FLAGPERSON NUMBER 2 IS TO RELAY SIGNALS BETWEEN FLAGPERSON NUMBER 1 AND FLAGPERSON NUMBER 3.
2. LINE OF SIGHT MUST BE MAINTAINED BETWEEN TWO CONSECUTIVE FLAGPERSONS.
3. ALL FLAGPERSON ACTIVITIES SHALL NOT COMMENCE UNTIL ALL SIGNS ARE IN PLACE.
4. THE INTERMEDIATE FLAGPERSON MAY BE ELIMINATED IF PROPER ELECTRONIC COMMUNICATION IS PROVIDED TO THE FLAGPERSONS.

757-2

TRAFFIC CONTROL MANUAL 2018

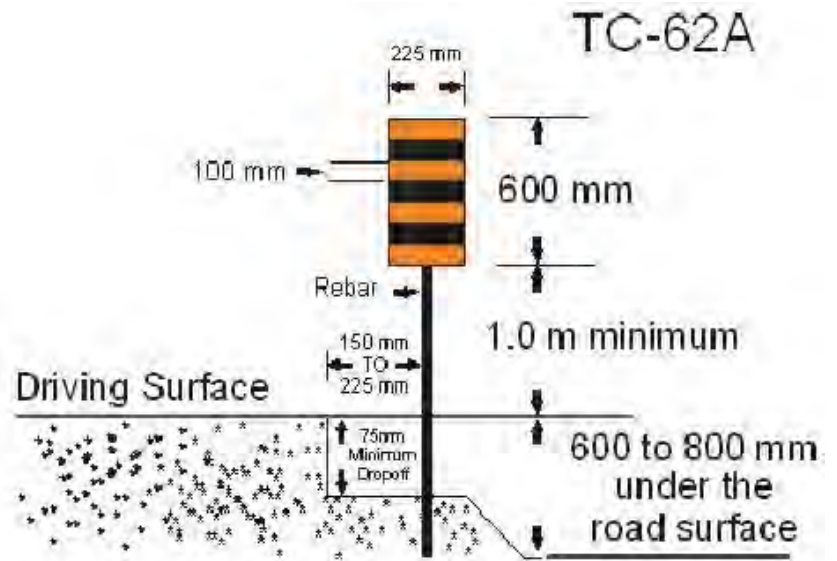
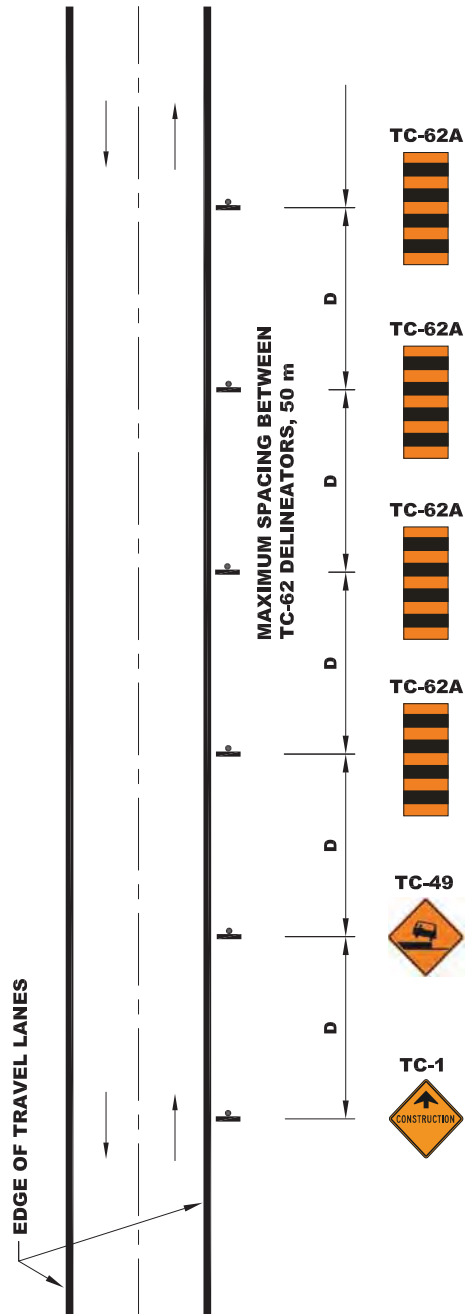

NOTE: TC 62A IS USED WHERE DELINEATORS ARE REQUIRED FOR A DISTANCE GREATER THAN 300 m.

758-1

TRAFFIC CONTROL MANUAL 2018

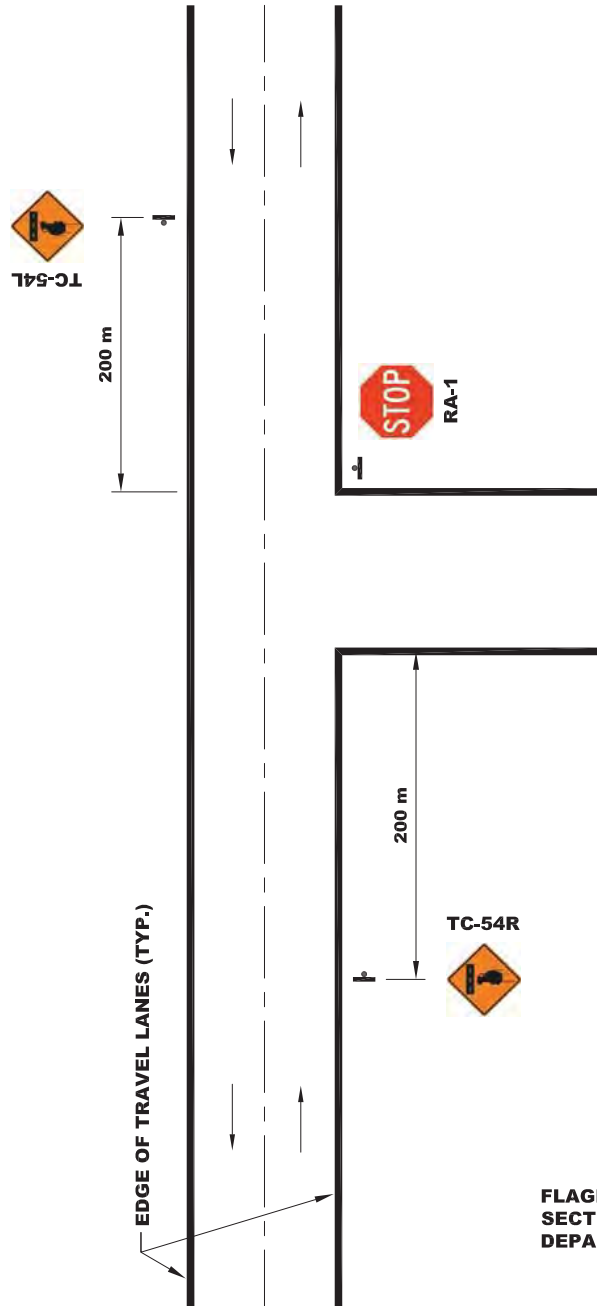

FLAGPERSON CONTROL AS PER
SECTION 715.05 (G) OR (H) OF THE
DEPARTMENT'S SPECIFICATION BOOK

759-1



TRANSPORTATION AND WORKS
HIGHWAY DESIGN DIVISION

TRUCK ENTRANCE

DRAWN BY: G. Clarke

DATE: Rev November 2018

NOT TO SCALE

TRAFFIC CONTROL MANUAL

2018

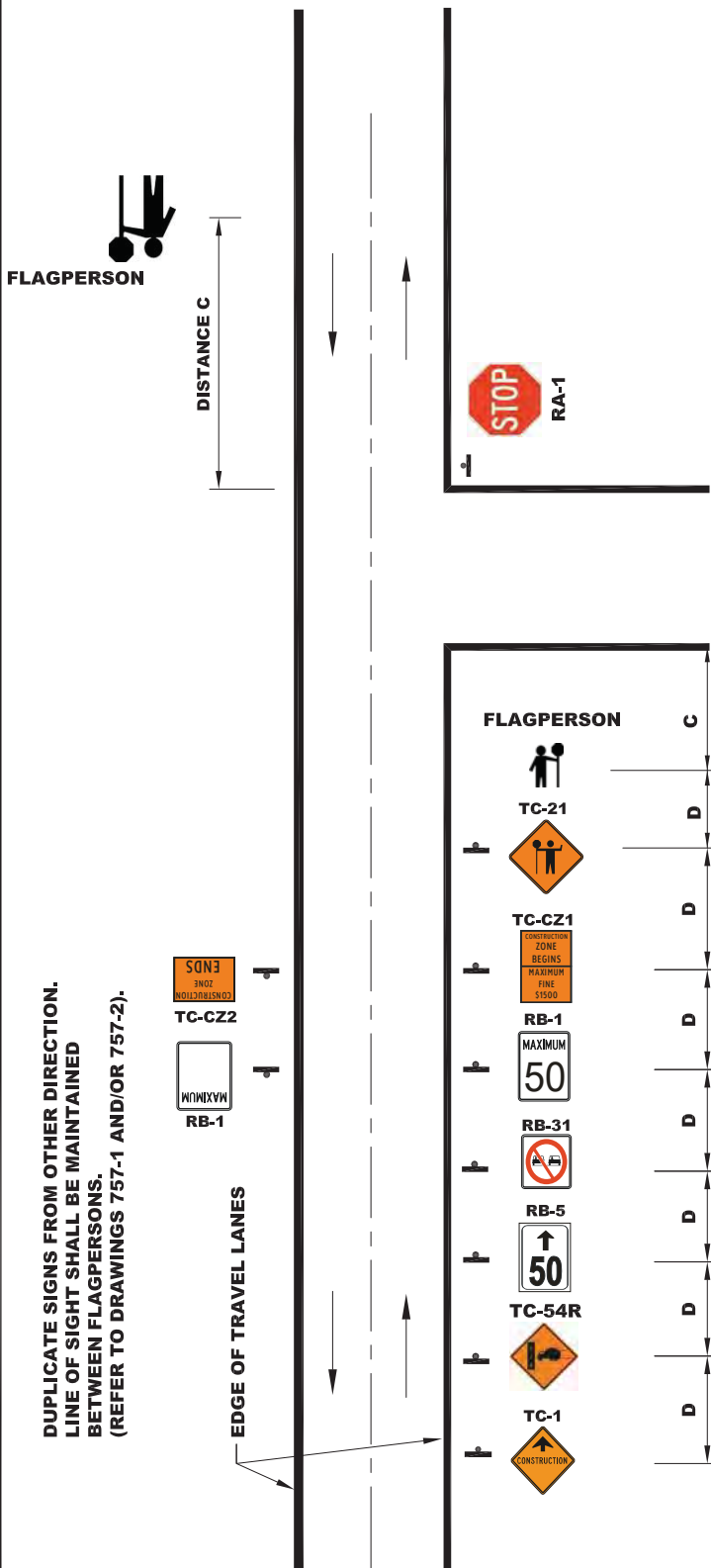

Duplicate signs from other direction. Line of sight shall be maintained between flagpersons. (Refer to drawings 757-1 and/or 757-2).

WORK ZONE DIMENSIONS FOR ONE LANE CLOSED SPEED LIMIT OVER 60 km/h

DIMENSION (m)	NORMAL POSTED REGULATORY SPEED					
	70	80	90	100	110	120
A	60	90	110	180		
B	5/15	5/15	5/18	5/20		
C	40	50	50	50		
D	75	100	100	150		
E	50	75	75	75		

- POSTED SPEED IS EXISTING SPEED LIMIT (km/h)
- A - TAPER LANE WHEN NO LANE CONTROL PRESENT
 - B - MAX. DELINEATOR SPACING IN TAPER/WORK ZONE
 - C - TRAFFIC CONTROL PERSON SETBACK (m)
 - D - DISTANCE BETWEEN CONSTRUCTION SIGNS
 - E - BUFFER AREA LENGTH BETWEEN TAPER AND WORK ZONE

NOTES

1. WHERE THE DURATION OF THIS ACTIVITY IS DEFINED AS "LONG TERM WORK" WITH HIGH SPEED AND HIGH VOLUME SIGN TC-CZ4 OR THE LARGER (1200mm X 2400mm) SIGN TC-CZ3 SHALL BE INSTALLED AS PER SECTION "PORTABLE OR REMOVABLE SIGN SUPPORTS WITH FLAGS", PAGE 4 AS WELL AS SECTION "PERMANENTLY INSTALLED TEMPORARY CONDITION SIGN SUPPORTS", PAGE 4.

759-1F

TRAFFIC CONTROL MANUAL 2018

TEMPORARY STRIPING APPLICATION

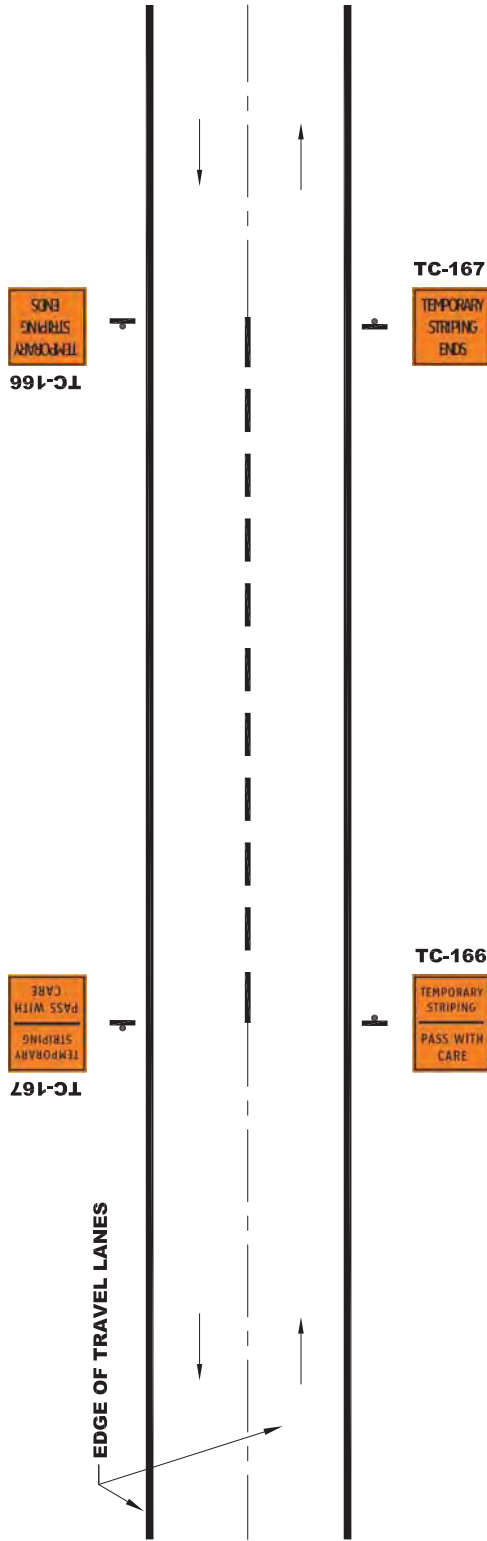

770-1



TRANSPORTATION AND WORKS
HIGHWAY DESIGN DIVISION

TEMPORARY STRIPING SIGNING

DRAWN BY: G. Clarke

DATE: Rev November 2018

NOT TO SCALE

TRAFFIC CONTROL MANUAL

2018

GENERAL PAINTING PRACTICES

PAINT CREW OR ROAD MARKING OPERATIONS SHALL COMPLY WITH THE FOLLOWING PRACTICES DURING OPERATIONS:

APPAREL:

ALL CREW MEMBERS WORKING ON OR NEAR THE ROADWAY SHALL WEAR CSA CERTIFIED PERSONAL PROTECTIVE EQUIPMENT.

CONE USAGE:

- 1. THREE ADVANCE CONES SHALL BE PLACED ON THE EDGE OF THE TRAVEL LANE, SPACED THE SAME DISTANCE APART AS THE SIGN SPACING.**
- 2. TAPERS TO BE USED WHEN DIVERTING TRAFFIC SHALL CONFORM TO THE CONSTRUCTION DISTANCE TABLE, 799-1.**
- 3. CONES USED FOR DELINEATION SHALL CONFORM TO THE CONSTRUCTION DISTANCE TABLE, 799-1.**

FLAGPERSONS:

- 1. FLAGPERSONS AND FLAGPERSON SIGNS (TC-21) SHALL BE USED WHERE AND WHEN SIGHT DISTANCE FROM THE LAST SIGN TO THE WORK ZONE DOES NOT EXCEED 150 m.**
- 2. WHEN MARKING TARGETS OR DOTTING, A FLAGPERSON SHALL BE USED.**

SEQUENCES:

WHEN PAINTING INTERSECTIONS, REFER TO THE ATTACHED DRAWINGS FOR PAINTING EITHER HIGH OR LOW VOLUME TRAFFIC AREAS. THESE SEQUENCES ARE TO ASSIST THE CREW WITH THE SAFEST METHOD OF PAINTING AND TO PROVIDE MINIMAL TRAFFIC INTERRUPTION WITH SAFETY AS KEY ELEMENT IN COMPLETING WORK.

771-1



TRANSPORTATION AND WORKS
HIGHWAY DESIGN DIVISION

LINE PAINTING PROCEDURES GENERAL PAINTING PRACTICES

DRAWN BY: G. Clarke

DATE: Rev June 2018

NOT TO SCALE

TRAFFIC CONTROL MANUAL 2018

NOTE: DUPLICATE SIGNS FROM OTHER DIRECTION.

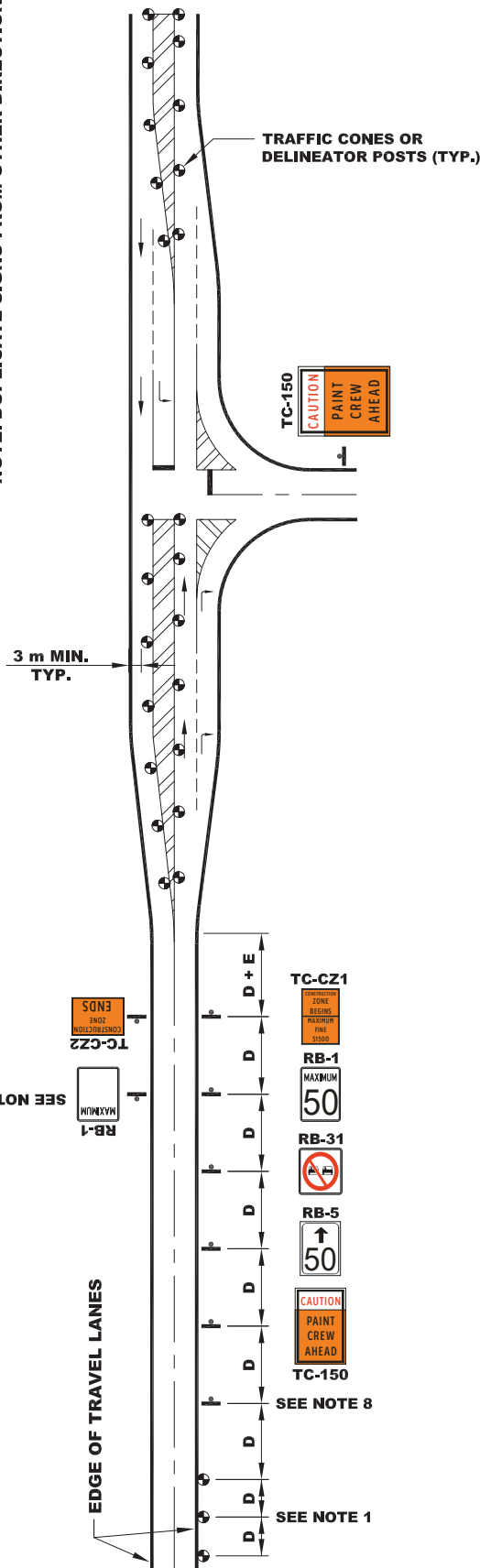

WORK ZONE DIMENSIONS FOR PAINTING CENTER CROSS HATCHING FOR 2 WAY TRAFFIC SPEED LIMITS > OR = TO 60 km/h						
DIMENSION (m)	NORMAL POSTED REGULATORY SPEED					
	60	70	80	90	100	
A	40	60	90	110	180	
B	8/12	10/15	10/15	12/18	15/20	
C	40	40	50	50	50	
D	50	75	100	100	150	
E	50	50	75	75	75	

POSTED SPEED IS EXISTING SPEED LIMIT (km/h)

A - TAPER LANE WHEN NO LANE CONTROL PRESENT

B - MAX. DELINEATOR SPACING IN TAPER/WORK ZONE

C - TRAFFIC CONTROL PERSON SETBACK (m)

D - DISTANCE BETWEEN CONSTRUCTION SIGNS

E - BUFFER AREA LENGTH BETWEEN TAPER AND WORK ZONE

NOTES

- THREE CONES TO BE PLACED IN ADVANCE OF SIGNS, AS SHOWN, EITHER ON THE SHOULDER OR ON THE CENTERLINE.
- ALL PERSONNEL WORKING ON OR NEAR THE ROADWAY MUST WEAR REQUIRED PERSONAL PROTECTIVE EQUIPMENT.
- TRAFFIC CONES ARE TO BE USED TO DEFINE ALL INDIVIDUAL WORK ZONES OR WHERE WET PAINT EXISTS AND TO CHANNELIZE TRAFFIC AS REQUIRED WITH WELL TAPERED ENDS AS SHOWN IN EXAMPLE ABOVE. CONE PLACEMENT MUST BE AS PER THE CONSTRUCTION DISTANCE TABLE ABOVE AND ON PAGE 799-1, INCLUDING TAPERS. PLACE CONES AFTER PAINTING COMPLETED.
- TWO ORANGE FLAGS TO BE MOUNTED ON EACH SIGN STAND.
- THE FLAGPERSON AND FLAGPERSON SIGN (TC-21) TO BE PLACED WHEN AND WHERE REQUIRED.
- WHEN PAINTING LANES, TRAFFIC MUST BE ALLOWED A THROUGH LANE AT ALL TIMES WITH A MINIMUM WIDTH OF 3 m. PAINTED AREAS MUST BE COMPLETELY CLOSED TO TRAFFIC.
- TEMPORARILY INSTALL AN RB-1 SPEED LIMIT SIGN TO DISPLAY THE NORMAL OPERATING SPEED LIMIT OF THE HIGHWAY.
- WHEN NORMAL POSTED SPEED IS GREATER THAN 80 km/h A VARIABLE MESSAGE SIGN IS RECOMMENDED, REFER TO 740-4
- DUPLICATE SIGNS FROM OTHER DIRECTION.

771-2



TRANSPORTATION AND WORKS
HIGHWAY DESIGN DIVISION

LINE PAINTING PROCEDURES PAINTING CENTER CROSS HATCHING SPEED LIMITS > OR = TO 60 km/h

DRAWN BY: G. CLARKE

DATE: Rev June 2018

NOT TO SCALE

TRAFFIC CONTROL MANUAL 2018

NOTE: DUPLICATE SIGNS FROM OTHER DIRECTION.

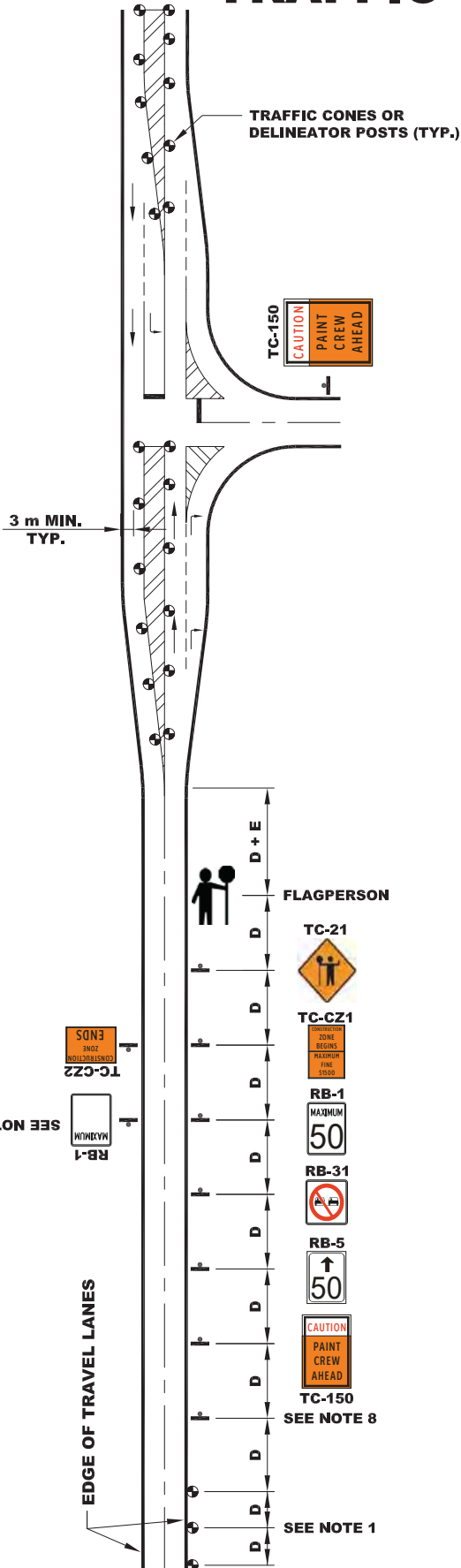

WORK ZONE DIMENSIONS FOR PAINTING CENTER CROSS HATCHING FOR 2 WAY TRAFFIC SPEED LIMITS > OR = TO 60 km/h WITH FLAGPERSONS

DIMENSION (m)	NORMAL POSTED REGULATORY SPEED				
	60	70	80	90	100
A	40	60	90	110	180
B	8/12	10/15	10/15	12/18	15/20
C	40	40	50	50	50
D	50	75	100	100	150
E	50	50	75	75	75

POSTED SPEED IS EXISTING SPEED LIMIT (km/h)

A - TAPER LANE WHEN NO LANE CONTROL PRESENT

B - MAX. DELINEATOR SPACING IN TAPER/WORK ZONE

C - TRAFFIC CONTROL PERSON SETBACK (m)

D - DISTANCE BETWEEN CONSTRUCTION SIGNS

E - BUFFER AREA LENGTH BETWEEN TAPER AND WORK ZONE

NOTES

- THREE CONES TO BE PLACED IN ADVANCE OF SIGNS, AS SHOWN, EITHER ON THE SHOULDER OR ON THE CENTERLINE.
- ALL PERSONNEL WORKING ON OR NEAR THE ROADWAY MUST WEAR REQUIRED PERSONAL PROTECTIVE EQUIPMENT.
- TRAFFIC CONES ARE TO BE USED TO DEFINE ALL INDIVIDUAL WORK ZONES OR WHERE WET PAINT EXISTS AND TO CHANNELIZE TRAFFIC AS REQUIRED WITH WELL TAPERED ENDS AS SHOWN IN EXAMPLE ABOVE. CONE PLACEMENT MUST BE AS PER THE CONSTRUCTION DISTANCE TABLE ABOVE AND ON PAGE 799-1, INCLUDING TAPERS. PLACE CONES AFTER PAINTING COMPLETED.
- TWO ORANGE FLAGS TO BE MOUNTED ON EACH SIGN STAND.
- THE FLAGPERSON AND FLAGPERSON SIGN (TC-21) TO BE PLACED WHEN AND WHERE REQUIRED.
- WHEN PAINTING LANES, TRAFFIC MUST BE ALLOWED A THROUGH LANE AT ALL TIMES WITH A MINIMUM WIDTH OF 3 m. PAINTED AREAS MUST BE COMPLETELY CLOSED TO TRAFFIC.
- INSTALL AN RB-1 SPEED LIMIT SIGN TO DISPLAY THE NORMAL OPERATING SPEED LIMIT OF THE HIGHWAY.
- WHEN NORMAL POSTED SPEED IS GREATER THAN 80 km/h VARIABLE MESSAGE SIGN IS RECOMMENDED, REFER TO 740-3.
- DUPLICATE SIGNS FROM OTHER DIRECTION.
- LINE OF SIGHT SHALL BE MAINTAINED BETWEEN FLAGPERSONS, REFER TO 757-1 AND 757-2.

771-2F



TRANSPORTATION AND WORKS
HIGHWAY DESIGN DIVISION

LINE PAINTING PROCEDURES

PAINTING CENTER CROSS HATCHING
SPEED LIMITS > OR = TO 60 km/h WITH FLAGPERSONS

DRAWN BY: G. CLARKE

DATE: Rev June 2018

NOT TO SCALE

TRAFFIC CONTROL MANUAL 2018

NOTE: DUPLICATE SIGNS FROM OTHER DIRECTION.

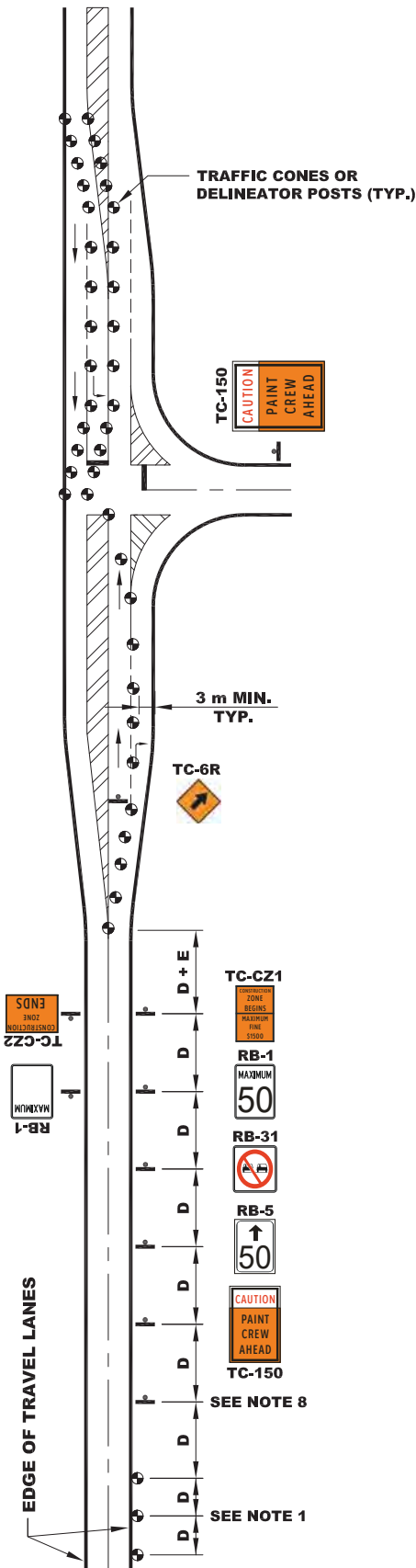

WORK ZONE DIMENSIONS FOR LEFT SIDE OF INTERSECTION - PAINTING THROUGH LANE FOR 2 WAY TRAFFIC SPEED LIMITS > OR = TO 60 km/h

DIMENSION (m)	NORMAL POSTED REGULATORY SPEED				
	60	70	80	90	100
A	40	60	90	110	180
B	8/12	10/15	10/15	12/18	15/20
C	40	40	50	50	50
D	50	75	100	100	150
E	50	50	75	75	75

POSTED SPEED IS EXISTING SPEED LIMIT (km/h)

A - TAPER LANE WHEN NO LANE CONTROL PRESENT

B - MAX. DELINEATOR SPACING IN TAPER/WORK ZONE

C - TRAFFIC CONTROL PERSON SETBACK (m)

D - DISTANCE BETWEEN CONSTRUCTION SIGNS

E - BUFFER AREA LENGTH BETWEEN TAPER AND WORK ZONE

NOTES

1. THREE CONES TO BE PLACED IN ADVANCE OF SIGNS, AS SHOWN, EITHER ON THE SHOULDER OR THE CENTERLINE.
2. ALL PERSONNEL WORKING ON OR NEAR THE ROADWAY MUST WEAR REQUIRED PERSONAL PROTECTIVE EQUIPMENT.
3. TRAFFIC CONES ARE TO BE USED TO DEFINE ALL INDIVIDUAL WORK ZONES OR WHERE WET PAINT EXISTS AND TO CHANNELIZE TRAFFIC AS REQUIRED WITH WELL TAPERED ENDS AS SHOWN IN EXAMPLE ABOVE. CONE PLACEMENT MUST BE AS PER THE CONSTRUCTION DISTANCE TABLE ABOVE AND ON PAGE 799-1, INCLUDING TAPERS.
4. TWO ORANGE FLAGS TO BE MOUNTED ON EACH SIGN STAND.
5. THE FLAGPERSON AND FLAGPERSON SIGN (TC-21) TO BE PLACED WHEN AND WHERE REQUIRED.
6. WHEN PAINTING LANES, TRAFFIC MUST BE ALLOWED A THROUGH LANE AT ALL TIMES WITH A MINIMUM WIDTH OF 3 m, PAINTED AREAS MUST BE COMPLETELY CLOSED TO TRAFFIC.
7. INSTALL AN RB-1 SPEED LIMIT SIGN TO DISPLAY THE NORMAL OPERATING SPEED LIMIT OF THE HIGHWAY.
8. WHEN NORMAL POSTED SPEED IS GREATER THAN 80 km/h VARIABLE MESSAGE SIGN IS RECOMMENDED, REFER TO 740-4.
9. DUPLICATE SIGNS FROM OTHER DIRECTION, REFER TO 771-3A.

771-3



TRANSPORTATION AND WORKS
HIGHWAY DESIGN DIVISION

LINE PAINTING PROCEDURES PAINTING IN THROUGH LANE (LEFT SIDE) SPEED LIMITS > OR = TO 60 km/h

DRAWN BY: G. CLARKE

DATE: Rev June 2018

NOT TO SCALE

TRAFFIC CONTROL MANUAL

2018

NOTE: DUPLICATE SIGNS FROM OTHER DIRECTION.

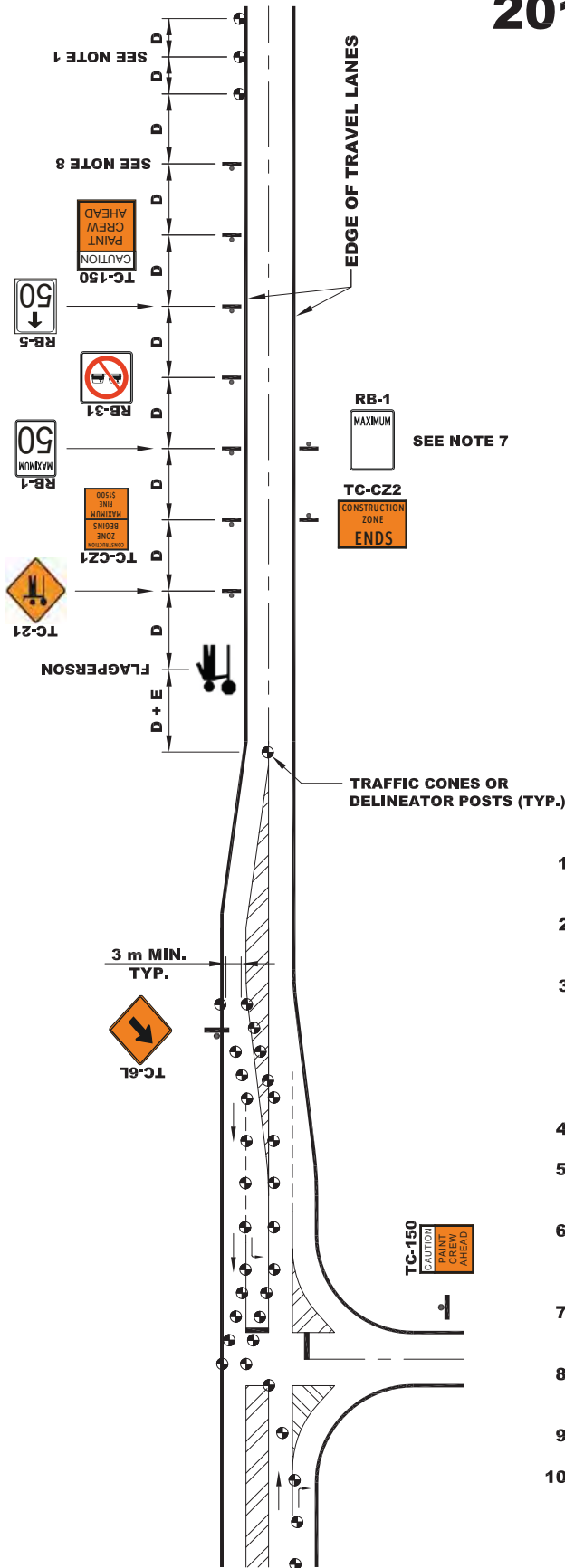

WORK ZONE DIMENSIONS FOR RIGHT SIDE OF INTERSECTION - PAINTING THROUGH LANE FOR 2 WAY TRAFFIC SPEED LIMITS > OR = TO 60 km/h

DIMENSION (m)	NORMAL POSTED REGULATORY SPEED				
	60	70	80	90	100
A	40	60	90	110	180
B	8/12	10/15	10/15	12/18	15/20
C	40	40	50	50	50
D	50	75	100	100	150
E	50	50	75	75	75

POSTED SPEED IS EXISTING SPEED LIMIT (km/h)

- A - TAPER LANE WHEN NO LANE CONTROL PRESENT
- B - MAX. DELINEATOR SPACING IN TAPER/WORK ZONE
- C - TRAFFIC CONTROL PERSON SETBACK (m)
- D - DISTANCE BETWEEN CONSTRUCTION SIGNS
- E - BUFFER AREA LENGTH BETWEEN TAPER AND WORK ZONE

NOTES

1. THREE CONES TO BE PLACED IN ADVANCE OF SIGNS AS SHOWN, EITHER ON SHOULDER OR CENTERLINE.
2. ALL PERSONNEL WORKING ON OR NEAR THE ROADWAY MUST WEAR REQUIRED PERSONAL PROTECTIVE EQUIPMENT.
3. TRAFFIC CONES ARE TO BE USED TO DEFINE ALL INDIVIDUAL WORK ZONES OR WHERE WET PAINT EXISTS AND TO CHANNELIZE TRAFFIC AS REQUIRED WITH WELL TAPERED ENDS AS SHOWN IN EXAMPLE ABOVE. CONE PLACEMENT MUST BE AS PER THE CONSTRUCTION DISTANCE TABLE ABOVE AND ON PAGE 799-1, INCLUDING TAPERS.
4. TWO ORANGE FLAGS TO BE MOUNTED ON EACH SIGN STAND.
5. THE FLAGPERSON AND FLAGPERSON SIGN (TC-21) TO BE PLACED WHEN AND WHERE REQUIRED.
6. WHEN PAINTING LANES, TRAFFIC MUST BE ALLOWED A THROUGH LANE AT ALL TIMES WITH A MINIMUM WIDTH OF 3 m, PAINTED AREAS MUST BE COMPLETELY CLOSED TO TRAFFIC.
7. INSTALL AN RB-1 SPEED LIMIT SIGN TO DISPLAY THE NORMAL OPERATING SPEED LIMIT OF THE HIGHWAY.
8. WHEN NORMAL POSTED SPEED IS GREATER THAN 80 km/h VARIABLE MESSAGE SIGN IS RECOMMENDED, REFER TO 740-3.
9. DUPLICATE SIGNAGE IN OTHER DIRECTION, SEE 771-3F.
10. LINE OF SIGHT TO BE MAINTAINED BETWEEN FLAGPERSONS, REFER TO 757-1 AND 757-2.

771-3AF



TRANSPORTATION AND WORKS
HIGHWAY DESIGN DIVISION

LINE PAINTING PROCEDURES PAINTING IN THROUGH LANE (RIGHT SIDE) SPEED LIMITS > OR = TO 60 km/h WITH FLAGPERSONS

DRAWN BY: G. CLARKE

DATE: Rev June 2018

NOT TO SCALE

TRAFFIC CONTROL MANUAL 2018

NOTE: DUPLICATE SIGNS FROM OTHER DIRECTION.

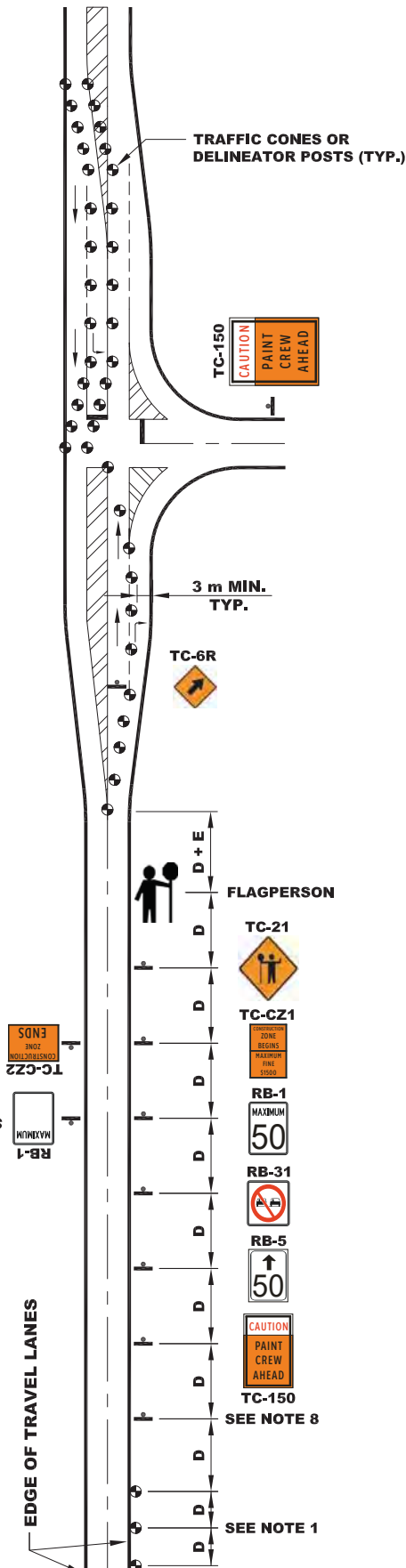

WORK ZONE DIMENSIONS FOR LEFT SIDE OF INTERSECTION - PAINTING THROUGH LANE FOR 2 WAY TRAFFIC SPEED LIMITS > OR = TO 60 km/h

DIMENSION (m)	NORMAL POSTED REGULATORY SPEED				
	60	70	80	90	100
A	40	60	90	110	180
B	8/12	10/15	10/15	12/18	15/20
C	40	40	50	50	50
D	50	75	100	100	150
E	50	50	75	75	75

POSTED SPEED IS EXISTING SPEED LIMIT (km/h)

A - TAPER LANE WHEN NO LANE CONTROL PRESENT

B - MAX. DELINEATOR SPACING IN TAPER/WORK ZONE

C - TRAFFIC CONTROL PERSON SETBACK (m)

D - DISTANCE BETWEEN CONSTRUCTION SIGNS

E - BUFFER AREA LENGTH BETWEEN TAPER AND WORK ZONE

NOTES

- THREE CONES TO BE PLACED IN ADVANCE OF SIGNS, AS SHOWN, EITHER ON THE SHOULDER OR THE CENTERLINE.
- ALL PERSONNEL WORKING ON OR NEAR THE ROADWAY MUST WEAR REQUIRED PERSONAL PROTECTIVE EQUIPMENT.
- TRAFFIC CONES ARE TO BE USED TO DEFINE ALL INDIVIDUAL WORK ZONES OR WHERE WET PAINT EXISTS AND TO CHANNELIZE TRAFFIC AS REQUIRED WITH WELL TAPERED ENDS AS SHOWN IN EXAMPLE ABOVE. CONE PLACEMENT MUST BE AS PER THE CONSTRUCTION DISTANCE TABLE ABOVE AND ON PAGE 799-1, INCLUDING TAPERS.
- TWO ORANGE FLAGS TO BE MOUNTED ON EACH SIGN STAND.
- THE FLAGPERSON AND FLAGPERSON SIGN (TC-21) TO BE PLACED WHEN AND WHERE REQUIRED.
- WHEN PAINTING LANES, TRAFFIC MUST BE ALLOWED A THROUGH LANE AT ALL TIMES WITH A MINIMUM WIDTH OF 3 m, PAINTED AREAS MUST BE COMPLETELY CLOSED TO TRAFFIC.
- INSTALL AN RB-1 SPEED LIMIT SIGN TO DISPLAY THE NORMAL OPERATING SPEED LIMIT OF THE HIGHWAY.
- WHEN NORMAL POSTED SPEED IS GREATER THAN 80 km/h VARIABLE MESSAGE SIGN IS RECOMMENDED, REFER TO 740-3.
- DUPLICATE SIGNS FROM OTHER DIRECTION, REFER TO 771-3AF.
- LINE OF SIGHT TO BE MAINTAINED BETWEEN FLAGPERSONS, REFER TO 757-1 AND 757-2.

771-3F



TRANSPORTATION AND WORKS
HIGHWAY DESIGN DIVISION

LINE PAINTING PROCEDURES

PAINTING IN THROUGH LANE (LEFT SIDE)
SPEED LIMITS > OR = TO 60 km/h WITH FLAGPERSONS

DRAWN BY: G. CLARKE

DATE: Rev June 2018

NOT TO SCALE

TRAFFIC CONTROL MANUAL

2018

NOTE: DUPLICATE SIGNS FROM OTHER DIRECTION.

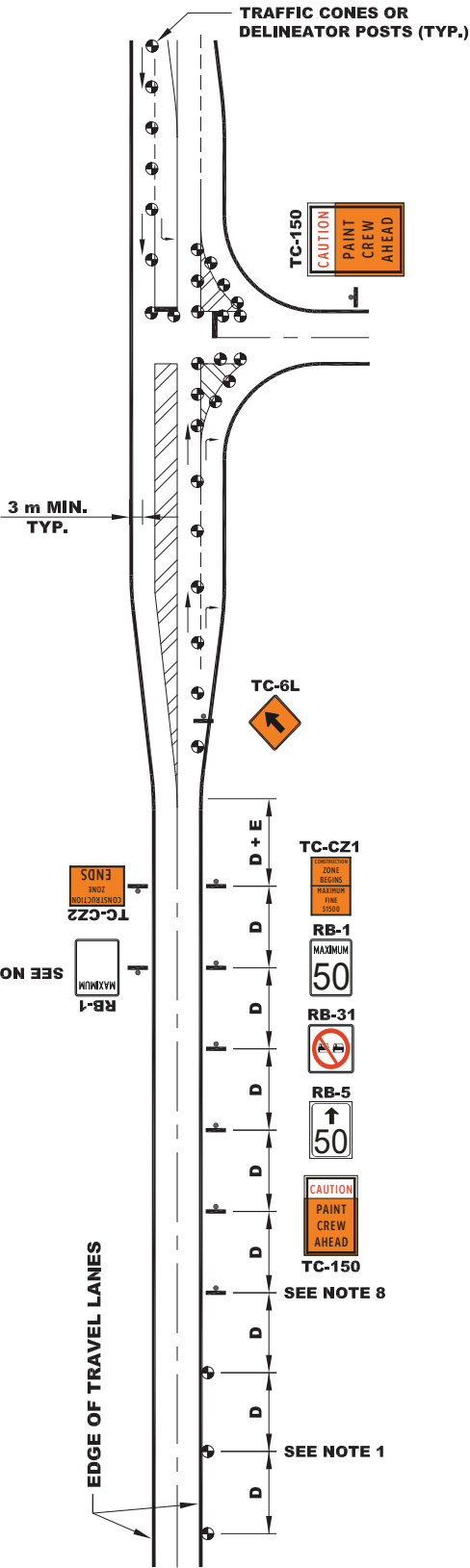

WORK ZONE DIMENSIONS FOR LEFT SIDE OF INTERSECTION - PAINTING TURNING ARROWS, STOP BARS AND ISLANDS FOR 2 WAY TRAFFIC SPEED LIMITS > OR = TO 60 km/h

DIMENSION (m)	NORMAL POSTED REGULATORY SPEED				
	60	70	80	90	100
A	40	60	90	110	180
B	8/12	10/15	10/15	12/18	15/20
C	40	40	50	50	50
D	50	75	100	100	150
E	50	50	75	75	75

POSTED SPEED IS EXISTING SPEED LIMIT (km/h)

A - TAPER LANE WHEN NO LANE CONTROL PRESENT

B - MAX. DELINEATOR SPACING IN TAPER/WORK ZONE

C - TRAFFIC CONTROL PERSON SETBACK (m)

D - DISTANCE BETWEEN CONSTRUCTION SIGNS

E - BUFFER AREA LENGTH BETWEEN TAPER AND WORK ZONE

NOTES

- THREE CONES TO BE PLACED IN ADVANCE OF SIGNS AS SHOWN, ALONG THE SHOULDER OR THE CENTERLINE.
- ALL PERSONNEL WORKING ON OR NEAR THE ROADWAY MUST WEAR REQUIRED PERSONAL EQUIPMENT.
- TRAFFIC CONES ARE TO BE USED TO DEFINE ALL INDIVIDUAL WORK ZONES OR WHERE WET PAINT EXISTS AND TO CHANNELIZE TRAFFIC AS REQUIRED WITH WELL TAPERED ENDS AS SHOWN IN EXAMPLE ABOVE. CONE PLACEMENT MUST BE AS PER THE CONSTRUCTION DISTANCE TABLE ABOVE AND ON PAGE 799-1, INCLUDING TAPERS. PLACE CONES ON ISLANDS AND STOP BARS AFTER PAINTING COMPLETED.
- TWO ORANGE FLAGS TO BE MOUNTED ON EACH SIGN STAND.
- THE FLAGPERSON AND FLAGPERSON SIGN (TC-21) TO BE PLACED WHEN AND WHERE REQUIRED.
- WHEN PAINTING LANES, TRAFFIC MUST BE ALLOWED A THROUGH LANE AT ALL TIMES WITH A MINIMUM WIDTH OF 3 m, PAINTED AREAS MUST BE COMPLETELY CLOSED TO TRAFFIC.
- INSTALL AN RB-1 SPEED LIMIT SIGN TO DISPLAY THE NORMAL OPERATING SPEED LIMIT OF THE HIGHWAY.
- WHEN NORMAL POSTED SPEED IS GREATER THAN 80 km/h VARIABLE MESSAGE SIGN IS RECOMMENDED, REFER TO 740-4.
- DUPLICATE SIGNS FROM OTHER DIRECTION, REFER TO 771-4A.

771-4



TRANSPORTATION AND WORKS
HIGHWAY DESIGN DIVISION

LINE PAINTING PROCEDURES PAINTING TURNING ARROWS, STOP BARS AND ISLANDS (LEFT SIDE) SPEED LIMITS > OR = TO 60 km/h

DRAWN BY: G. CLARKE

DATE: Rev June 2018

NOT TO SCALE

TRAFFIC CONTROL MANUAL

2018

NOTE: DUPLICATE SIGNS FROM OTHER DIRECTION.

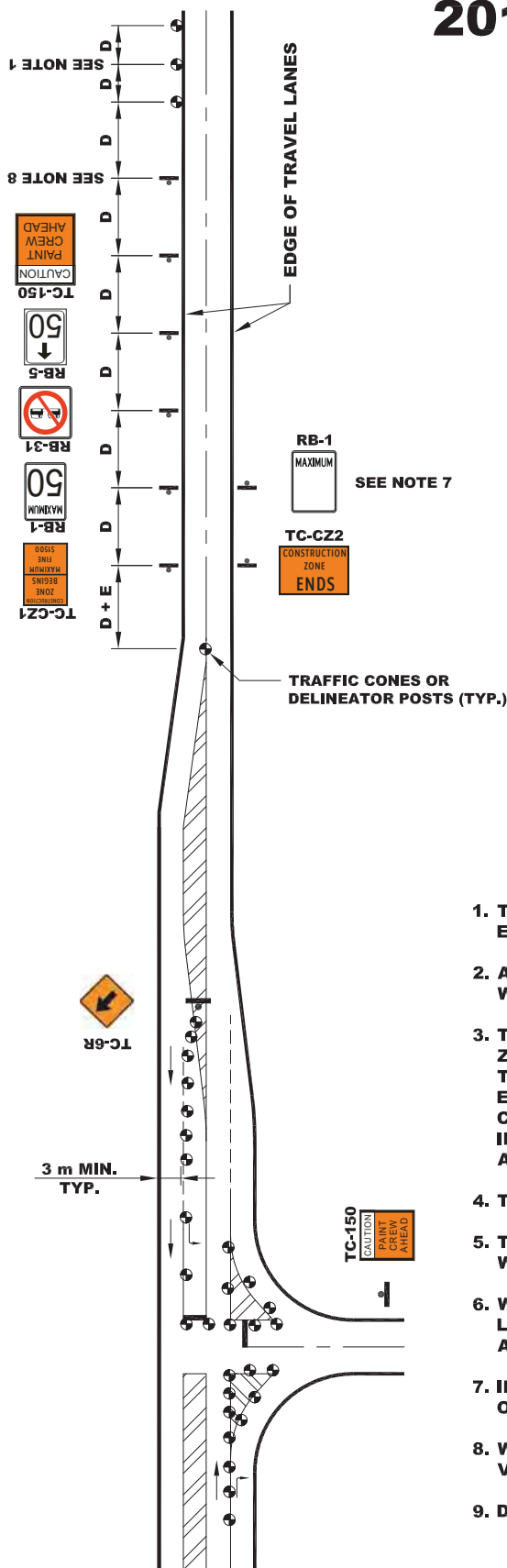

WORK ZONE DIMENSIONS FOR RIGHT SIDE OF INTERSECTION - PAINTING TURNING ARROWS, STOP BARS AND ISLANDS FOR 2 WAY TRAFFIC SPEED LIMITS > OR = TO 60 km/h

DIMENSION (m)	NORMAL POSTED REGULATORY SPEED				
	60	70	80	90	100
A	40	60	90	110	180
B	8/12	10/15	10/15	12/18	15/20
C	40	40	50	50	50
D	50	75	100	100	150
E	50	50	75	75	75

POSTED SPEED IS EXISTING SPEED LIMIT (km/h)

- A - TAPER LANE WHEN NO LANE CONTROL PRESENT
- B - MAX. DELINEATOR SPACING IN TAPER/WORK ZONE
- C - TRAFFIC CONTROL PERSON SETBACK (m)
- D - DISTANCE BETWEEN CONSTRUCTION SIGNS
- E - BUFFER AREA LENGTH BETWEEN TAPER AND WORK ZONE

NOTES

1. THREE CONES TO BE PLACED IN ADVANCE OF SIGNS, AS SHOWN, EITHER ON THE SHOULDER OR THE CENTERLINE.
2. ALL PERSONNEL WORKING ON OR NEAR THE ROADWAY MUST WEAR REQUIRED PERSONAL PROTECTIVE EQUIPMENT.
3. TRAFFIC CONES ARE TO BE USED TO DEFINE ALL INDIVIDUAL WORK ZONES OR WHERE WET PAINT EXISTS AND TO CHANNELIZE TRAFFIC AS REQUIRED WITH WELL TAPERED ENDS AS SHOWN IN EXAMPLE ABOVE. CONE PLACEMENT MUST BE AS PER THE CONSTRUCTION DISTANCE TABLE ABOVE AND ON PAGE 799-1, INCLUDING TAPERS. PLACE CONES ON ISLANDS AND STOP BARS AFTER PAINTING COMPLETED.
4. TWO ORANGE FLAGS TO BE MOUNTED ON EACH SIGN STAND.
5. THE FLAGPERSON AND FLAGPERSON SIGN (TC-21) TO BE PLACED WHEN AND WHERE REQUIRED.
6. WHEN PAINTING LANES, TRAFFIC MUST BE ALLOWED A THROUGH LANE AT ALL TIMES WITH A MINIMUM WIDTH OF 3 m, PAINTED AREAS MUST BE COMPLETELY CLOSED TO TRAFFIC.
7. INSTALL AN RB-1 SPEED LIMIT SIGN TO DISPLAY THE NORMAL OPERATING SPEED LIMIT OF THE HIGHWAY.
8. WHEN NORMAL POSTED SPEED IS GREATER THAN 80 km/h VARIABLE MESSAGE SIGN IS RECOMMENDED, REFER TO 740-4.
9. DUPLICATE SIGNS FROM THE OTHER DIRECTION, REFER TO 771-4.

771-4A



TRANSPORTATION AND WORKS
HIGHWAY DESIGN DIVISION

LINE PAINTING PROCEDURES

PAINTING TURNING ARROWS, STOP BARS AND ISLANDS (RIGHT SIDE)
SPEED LIMITS > OR = TO 60 km/h

DRAWN BY: G. Clarke

DATE: Rev June 2018

NOT TO SCALE

TRAFFIC CONTROL MANUAL 2018

NOTE: DUPLICATE SIGNS FROM OTHER DIRECTION.

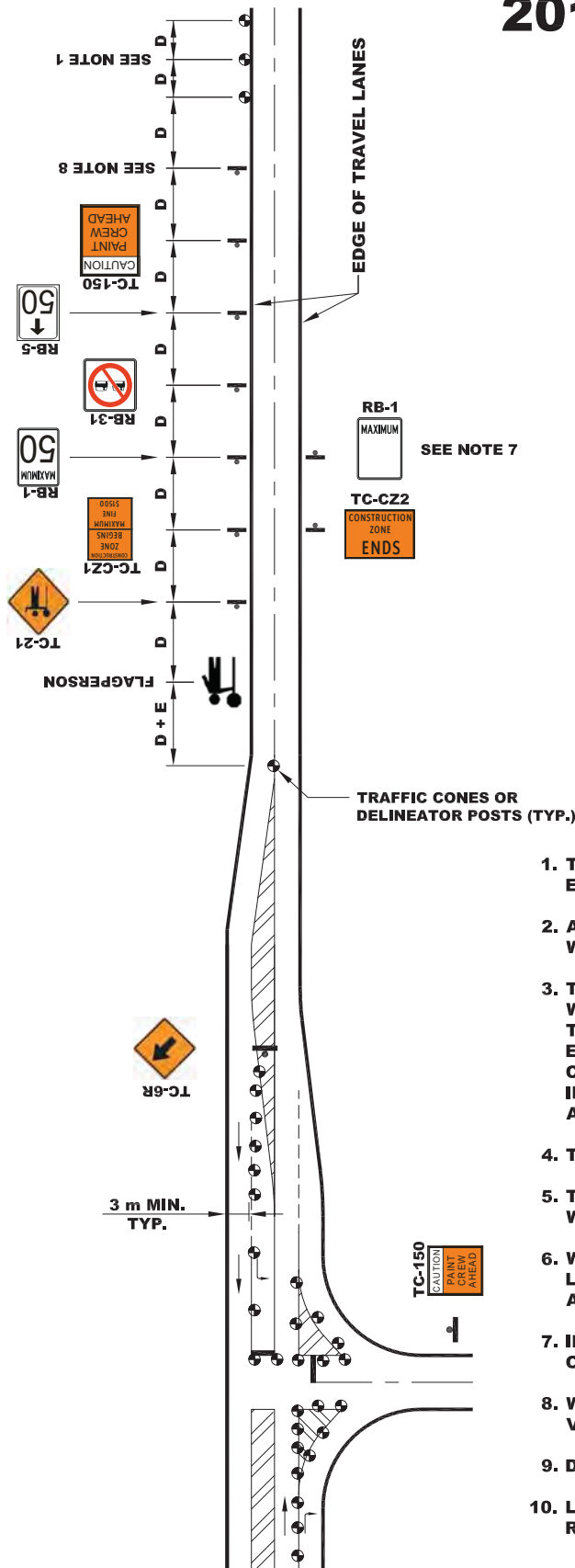

WORK ZONE DIMENSIONS FOR RIGHT SIDE OF INTERSECTION - PAINTING TURNING ARROWS, STOP BARS AND ISLANDS FOR 2 WAY TRAFFIC SPEED LIMITS > OR = TO 60 km/h

DIMENSION (m)	NORMAL POSTED REGULATORY SPEED				
	60	70	80	90	100
A	40	60	90	110	180
B	8/12	10/15	10/15	12/18	15/20
C	40	40	50	50	50
D	50	75	100	100	150
E	50	50	75	75	75

POSTED SPEED IS EXISTING SPEED LIMIT (km/h)

A - TAPER LANE WHEN NO LANE CONTROL PRESENT

B - MAX. DELINEATOR SPACING IN TAPER/WORK ZONE

C - TRAFFIC CONTROL PERSON SETBACK (m)

D - DISTANCE BETWEEN CONSTRUCTION SIGNS

E - BUFFER AREA LENGTH BETWEEN TAPER AND WORK ZONE

NOTES

- THREE CONES TO BE PLACED IN ADVANCE OF SIGNS, AS SHOWN, EITHER ON THE SHOULDER OR THE CENTERLINE.
- ALL PERSONNEL WORKING ON OR NEAR THE ROADWAY MUST WEAR REQUIRED PERSONAL PROTECTIVE EQUIPMENT.
- TRAFFIC CONES ARE TO BE USED TO DEFINE ALL INDIVIDUAL WORK ZONES OR WHERE WET PAINT EXISTS AND TO CHANNELIZE TRAFFIC AS REQUIRED WITH WELL TAPERED ENDS AS SHOWN IN EXAMPLE ABOVE. CONE PLACEMENT MUST BE AS PER THE CONSTRUCTION DISTANCE TABLE ABOVE AND ON PAGE 799-1, INCLUDING TAPERS. PLACE CONES ON ISLANDS AND STOP BARS AFTER PAINTING COMPLETED.
- TWO ORANGE FLAGS TO BE MOUNTED ON EACH SIGN STAND.
- THE FLAGPERSON AND FLAGPERSON SIGN (TC-21) TO BE PLACED WHEN AND WHERE REQUIRED.
- WHEN PAINTING LANES, TRAFFIC MUST BE ALLOWED A THROUGH LANE AT ALL TIMES WITH A MINIMUM WIDTH OF 3 m, PAINTED AREAS MUST BE COMPLETELY CLOSED TO TRAFFIC.
- INSTALL AN RB-1 SPEED LIMIT SIGN TO DISPLAY THE NORMAL OPERATING SPEED LIMIT OF THE HIGHWAY.
- WHEN NORMAL POSTED SPEED IS GREATER THAN 80 km/h VARIABLE MESSAGE SIGN IS RECOMMENDED, REFER TO 740-3.
- DUPLICATE SIGNS FROM THE OTHER DIRECTION, REFER TO 771-4F.
- LINE OF SIGHT SHALL BE MAINTAINED BETWEEN FLAGPERSONS. REFER TO 757-1 AND 757-2.

771-4AF



TRANSPORTATION AND WORKS
HIGHWAY DESIGN DIVISION

LINE PAINTING PROCEDURES PAINTING TURNING ARROWS, STOP BARS AND ISLANDS (RIGHT SIDE) SPEED LIMITS > OR = TO 60 km/h WITH FLAGPERSONS

DRAWN BY: G. Clarke

DATE: Rev June 2018

NOT TO SCALE

TRAFFIC CONTROL MANUAL

2018

NOTE: DUPLICATE SIGNS FROM OTHER DIRECTION.

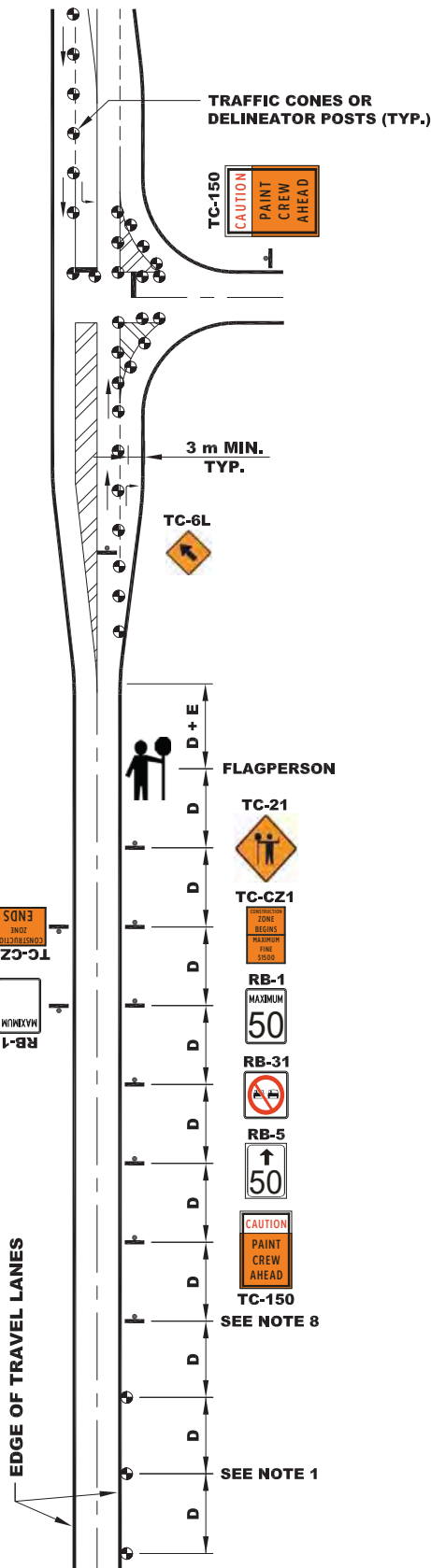

WORK ZONE DIMENSIONS FOR LEFT SIDE OF INTERSECTION - PAINTING TURNING ARROWS, STOP BARS AND ISLANDS FOR 2 WAY TRAFFIC SPEED LIMITS > OR = TO 60 km/h						
NORMAL POSTED REGULATORY SPEED						
DIMENSION (m)	60	70	80	90	100	
A	40	60	90	110	180	
B	8/12	10/15	10/15	12/18	15/20	
C	40	40	50	50	50	
D	50	75	100	100	150	
E	50	50	75	75	75	

POSTED SPEED IS EXISTING SPEED LIMIT (km/h)

A - TAPER LANE WHEN NO LANE CONTROL PRESENT

B - MAX. DELINEATOR SPACING IN TAPER/WORK ZONE

C - TRAFFIC CONTROL PERSON SETBACK (m)

D - DISTANCE BETWEEN CONSTRUCTION SIGNS

E - BUFFER AREA LENGTH BETWEEN TAPER AND WORK ZONE

NOTES

- THREE CONES TO BE PLACED IN ADVANCE OF SIGNS AS SHOWN, ALONG THE SHOULDER OR THE CENTERLINE.
- ALL PERSONNEL WORKING ON OR NEAR THE ROADWAY MUST WEAR REQUIRED PERSONAL EQUIPMENT.
- TRAFFIC CONES ARE TO BE USED TO DEFINE ALL INDIVIDUAL WORK ZONES OR WHERE WET PAINT EXISTS AND TO CHANNELIZE TRAFFIC AS REQUIRED WITH WELL TAPERED ENDS AS SHOWN IN EXAMPLE ABOVE. CONE PLACEMENT MUST BE AS PER THE CONSTRUCTION DISTANCE TABLE ABOVE AND ON PAGE 799-1, INCLUDING TAPERS. PLACE CONES ON ISLANDS AND STOP BARS AFTER PAINTING COMPLETED.
- TWO ORANGE FLAGS TO BE MOUNTED ON EACH SIGN STAND.
- THE FLAGPERSON AND FLAGPERSON SIGN (TC-21) TO BE PLACED WHEN AND WHERE REQUIRED.
- WHEN PAINTING LANES, TRAFFIC MUST BE ALLOWED A THROUGH LANE AT ALL TIMES WITH A MINIMUM WIDTH OF 3 m, PAINTED AREAS MUST BE COMPLETELY CLOSED TO TRAFFIC.
- INSTALL AN RB-1 SPEED LIMIT SIGN TO DISPLAY THE NORMAL OPERATING SPEED LIMIT OF THE HIGHWAY.
- WHEN NORMAL POSTED SPEED LIMIT IS GREATER THAN 80 km/h VARIABLE MESSAGE SIGN IS RECOMMENDED, REFER TO 740-3.
- DUPLICATE SIGNS FROM OTHER DIRECTION, REFER TO 771-4AF.
- LINE OF SIGHT SHALL BE MAINTAINED BETWEEN FLAGPERSONS, REFER TO 757-1 AND 757-2.

771-4F



TRANSPORTATION AND WORKS
HIGHWAY DESIGN DIVISION

LINE PAINTING PROCEDURES

PAINTING TURNING ARROWS, STOP BARS AND ISLANDS (LEFT SIDE)
SPEED LIMITS > OR = TO 60 km/h WITH FLAGPERSONS

DRAWN BY: G. Clarke

DATE: Rev June 2018

NOT TO SCALE

TRAFFIC CONTROL MANUAL

2018

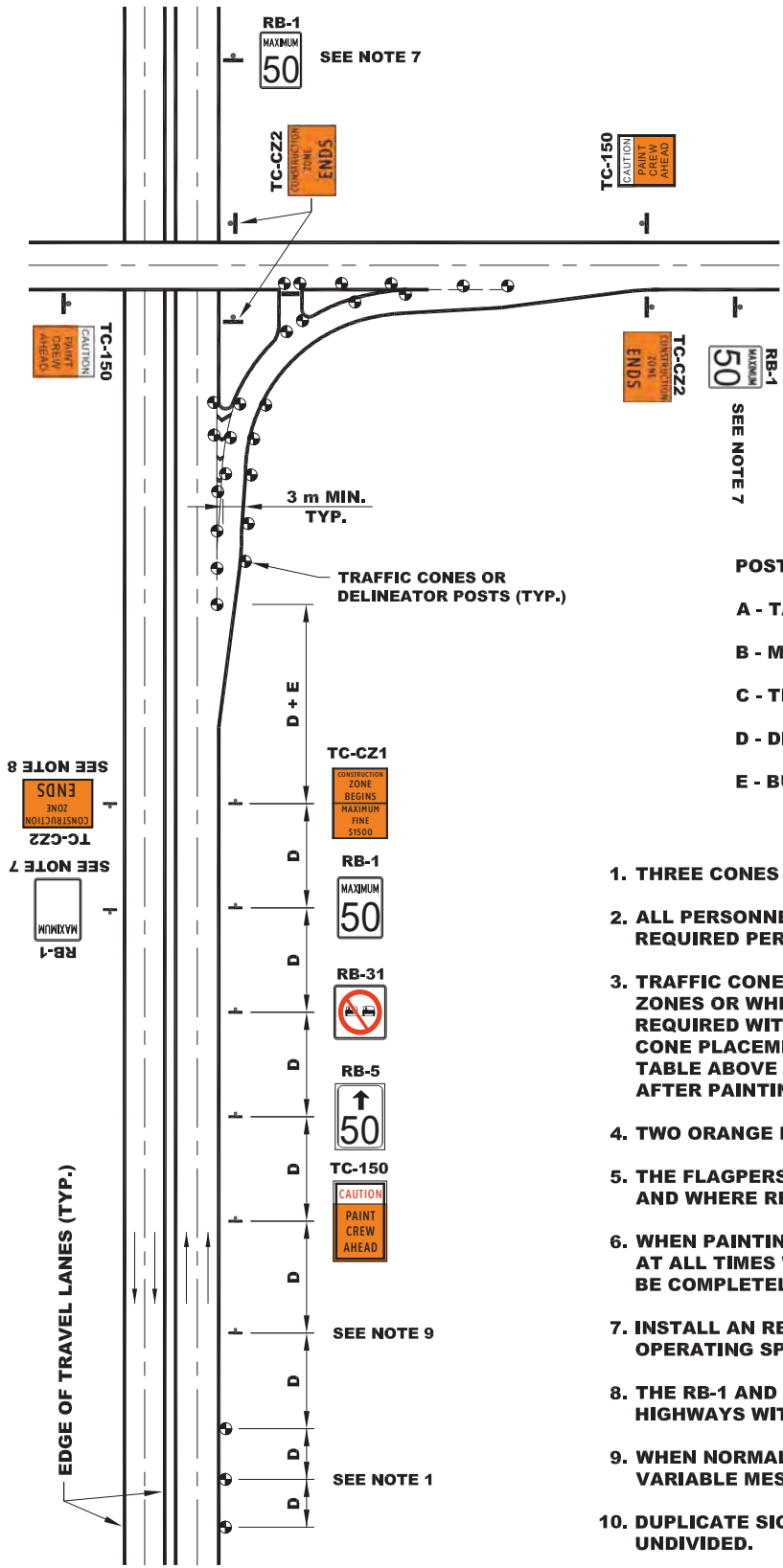

WORK ZONE DIMENSIONS FOR BULLNOSE CROSS HATCHING AND STOP BAR RAMP PAINTING

DIMENSION (m)	NORMAL POSTED REGULATORY SPEED					
	50	60	70	80	90	100
A	30	40	60	90	110	180
B	5/8	8/12	10/15	10/15	12/18	15/20
C	30	40	40	50	50	50
D	50	50	75	100	100	150
E	35	50	50	75	75	75

- POSTED SPEED IS EXISTING SPEED LIMIT (km/h)**
- A - TAPER LANE WHEN NO LANE CONTROL PRESENT**
 - B - MAX. DELINEATOR SPACING IN TAPER/WORK ZONE**
 - C - TRAFFIC CONTROL PERSON SETBACK (m)**
 - D - DISTANCE BETWEEN CONSTRUCTION SIGNS**
 - E - BUFFER AREA LENGTH BETWEEN TAPER AND WORK ZONE**

NOTES

1. THREE CONES TO BE PLACED IN ADVANCE OF SIGNS AS SHOWN.
2. ALL PERSONNEL WORKING ON OR NEAR THE ROADWAY MUST WEAR REQUIRED PERSONAL PROTECTION EQUIPMENT.
3. TRAFFIC CONES ARE TO BE USED TO DEFINE ALL INDIVIDUAL WORK ZONES OR WHERE WET PAINT EXISTS AND TO CHANNELIZE TRAFFIC AS REQUIRED WITH WELL TAPERED ENDS AS SHOWN IN EXAMPLE ABOVE. CONE PLACEMENT MUST BE AS PER THE CONSTRUCTION DISTANCE TABLE ABOVE AND ON PAGE 799-1, INCLUDING TAPERS. PLACE CONES AFTER PAINTING COMPLETED.
4. TWO ORANGE FLAGS TO BE MOUNTED ON EACH SIGN STAND.
5. THE FLAGPERSON AND FLAGPERSON SIGN (TC-21) TO BE PLACED WHEN AND WHERE REQUIRED.
6. WHEN PAINTING LANES, TRAFFIC MUST BE ALLOWED A THROUGH LANE AT ALL TIMES WITH A MINIMUM WIDTH OF 3 m, PAINTED AREAS MUST BE COMPLETELY CLOSED TO TRAFFIC.
7. INSTALL AN RB-1 SPEED LIMIT SIGN TO DISPLAY THE NORMAL OPERATING SPEED LIMIT OF THE HIGHWAY.
8. THE RB-1 AND TC-CZ2 SIGNS ARE NOT REQUIRED ON DIVIDED HIGHWAYS WITH A MEDIAN DIVIDER.
9. WHEN NORMAL POSTED SPEED LIMIT IS GREATER THAN 80 km/h VARIABLE MESSAGE SIGN IS RECOMMENDED, REFER TO 740-4.
10. DUPLICATE SIGNS FROM OTHER DIRECTION WHEN HIGHWAY IS UNDIVIDED.

771-5



TRAFFIC CONTROL MANUAL 2018

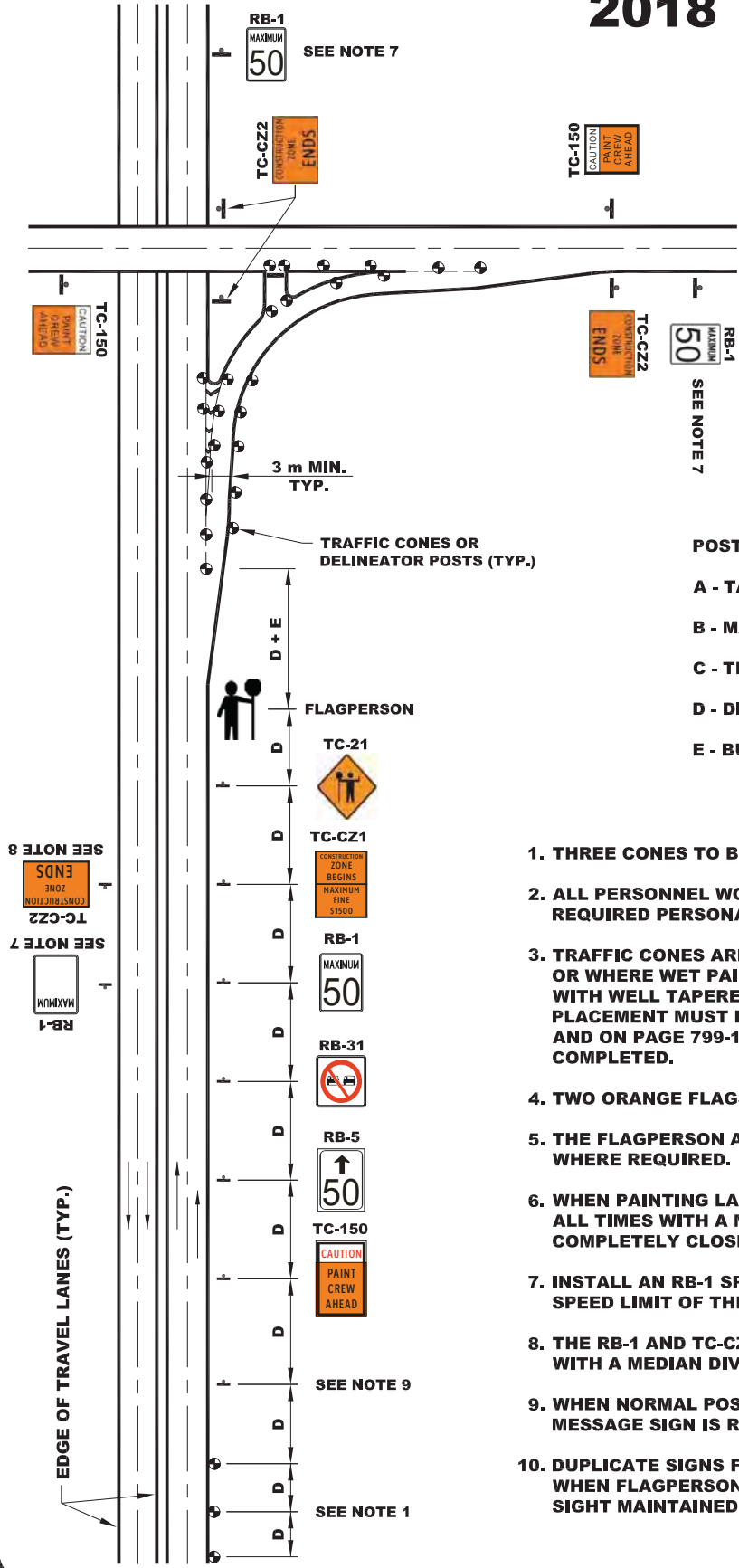

WORK ZONE DIMENSIONS FOR RAMP PAINTING INCLUDING BULLNOSE, CROSS HATCHING AND STOP BARS WITH FLAGPERSONS

DIMENSION (m)	NORMAL POSTED REGULATORY SPEED					
	50	60	70	80	90	100
A	30	40	60	90	110	180
B	5/8	8/12	10/15	10/15	12/18	15/20
C	30	40	40	50	50	50
D	50	50	75	100	100	150
E	35	50	50	75	75	75

POSTED SPEED IS EXISTING SPEED LIMIT (km/h)

A - TAPER LANE WHEN NO LANE CONTROL PRESENT

B - MAX. DELINEATOR SPACING IN TAPER/WORK ZONE

C - TRAFFIC CONTROL PERSON SETBACK (m)

D - DISTANCE BETWEEN CONSTRUCTION SIGNS

E - BUFFER AREA LENGTH BETWEEN TAPER AND WORK ZONE

NOTES

- THREE CONES TO BE PLACED IN ADVANCE OF SIGNS AS SHOWN.
- ALL PERSONNEL WORKING ON OR NEAR THE ROADWAY MUST WEAR REQUIRED PERSONAL PROTECTION EQUIPMENT.
- TRAFFIC CONES ARE TO BE USED TO DEFINE ALL INDIVIDUAL WORK ZONES OR WHERE WET PAINT EXISTS AND TO CHANNELIZE TRAFFIC AS REQUIRED WITH WELL TAPERED ENDS AS SHOWN IN EXAMPLE ABOVE. CONE PLACEMENT MUST BE AS PER THE CONSTRUCTION DISTANCE TABLE ABOVE AND ON PAGE 799-1, INCLUDING TAPERS. PLACE CONES AFTER PAINTING COMPLETED.
- TWO ORANGE FLAGS TO BE MOUNTED ON EACH SIGN.
- THE FLAGPERSON AND FLAGPERSON SIGN (TC-21) TO BE PLACED WHEN AND WHERE REQUIRED.
- WHEN PAINTING LANES, TRAFFIC MUST BE ALLOWED A THROUGH LANE AT ALL TIMES WITH A MINIMUM WIDTH OF 3 m, PAINTED AREAS MUST BE COMPLETELY CLOSED TO TRAFFIC.
- INSTALL AN RB-1 SPEED LIMIT SIGN TO DISPLAY THE NORMAL OPERATING SPEED LIMIT OF THE HIGHWAY.
- THE RB-1 AND TC-CZ2 SIGNS ARE NOT REQUIRED ON DIVIDED HIGHWAYS WITH A MEDIAN DIVIDER.
- WHEN NORMAL POSTED SPEED IS GREATER THAN 80 km/h VARIABLE MESSAGE SIGN IS RECOMMENDED, REFER TO 740-3.
- DUPLICATE SIGNS FROM OTHER DIRECTION WHEN HIGHWAY IS UNDIVIDED. WHEN FLAGPERSONS USED ON AN UNDIVIDED HIGHWAY ENSURE LINE OF SIGHT MAINTAINED BETWEEN FLAGPERSONS, REFER TO 757-1 AND 757-2.

771-5F

TRAFFIC CONTROL MANUAL 2018

NOTE: SAME SIGNAGE IN OPPOSITE DIRECTION BUT ELIMINATE TC-5L, TC-6, TC-21, AND THE FLAGPERSON

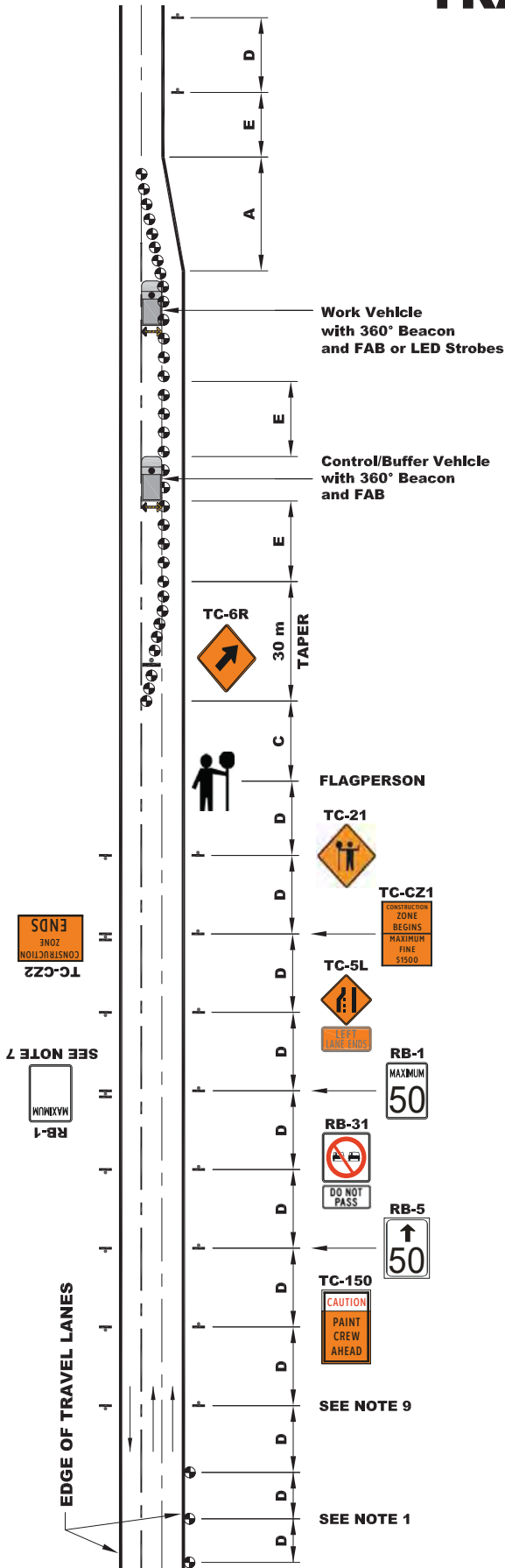

WORK ZONE DIMENSIONS FOR PAINTING IN LEFT LANE OR CLIMBING LANE (WORDS AND SYMBOLS)

DIMENSION (m)	NORMAL POSTED REGULATORY SPEED					
	50	60	70	80	90	100
A	30	40	60	90	110	180
B	5/8	8/12	10/15	10/15	12/18	15/20
C	30	40	40	50	50	50
D	50	50	75	100	100	150
E	35	50	50	75	75	75

POSTED SPEED IS EXISTING SPEED LIMIT (km/h)

A - TAPER LANE WHEN NO LANE CONTROL PRESENT

B - MAX. DELINEATOR SPACING IN TAPER/WORK ZONE

C - TRAFFIC CONTROL PERSON SETBACK (m)

D - DISTANCE BETWEEN CONSTRUCTION SIGNS

E - BUFFER AREA LENGTH BETWEEN TAPER AND WORK ZONE

NOTES

- THREE CONES TO BE PLACED IN ADVANCE OF SIGNS AS SHOWN, ALONG THE SHOULDER.
- ALL PERSONNEL WORKING ON OR NEAR THE ROADWAY MUST WEAR REQUIRED PERSONAL PROTECTIVE EQUIPMENT.
- TRAFFIC CONES ARE TO BE USED TO DEFINE ALL INDIVIDUAL WORK ZONES OR WHERE WET PAINT EXISTS AND TO CHANNELIZE TRAFFIC AS REQUIRED WITH WELL TAPERED ENDS AS SHOWN IN EXAMPLE ABOVE. CONE PLACEMENT MUST BE AS PER THE CONSTRUCTION DISTANCE TABLE ABOVE AND PAGE 799-1, INCLUDING TAPERS.
- TWO ORANGE FLAGS TO BE MOUNTED ON EACH SIGN.
- THE FLAGPERSON AND FLAGPERSON SIGN (TC-21) TO BE PLACED WHEN AND WHERE REQUIRED.
- WHEN PAINTING LANES, TRAFFIC MUST BE ALLOWED A THROUGH LANE AT ALL TIMES WITH A MINIMUM WIDTH OF 3 m, PAINTED AREAS MUST BE COMPLETELY CLOSED TO TRAFFIC.
- INSTALL AN RB-1 SPEED LIMIT SIGN TO DISPLAY THE NORMAL OPERATING SPEED LIMIT OF THE HIGHWAY.
- POST SIGNS ON BOTH SIDES OF ROAD WITH A PASSING LANE.
- WHEN NORMAL POSTED SPEED IS GREATER THAN 80 km/h VARIABLE MESSAGE SIGN, IS RECOMMENDED, REFER TO 740-4.
- DUPLICATE SIGNS IN OTHER DIRECTION BUT ELIMINATE THE TC-5L, TC-6, TC-21, AND THE FLAGPERSON

771-6



TRANSPORTATION AND WORKS
HIGHWAY DESIGN DIVISION

LINE PAINTING PROCEDURES PAINTING IN LEFT LANE OR CLIMBING LANE (WORDS OR SYMBOLS)

DRAWN BY: G. Clarke

DATE: Rev June 2018

NOT TO SCALE

TRAFFIC CONTROL MANUAL

2018

NOTE: DUPLICATE SIGNS FROM OTHER DIRECTION.

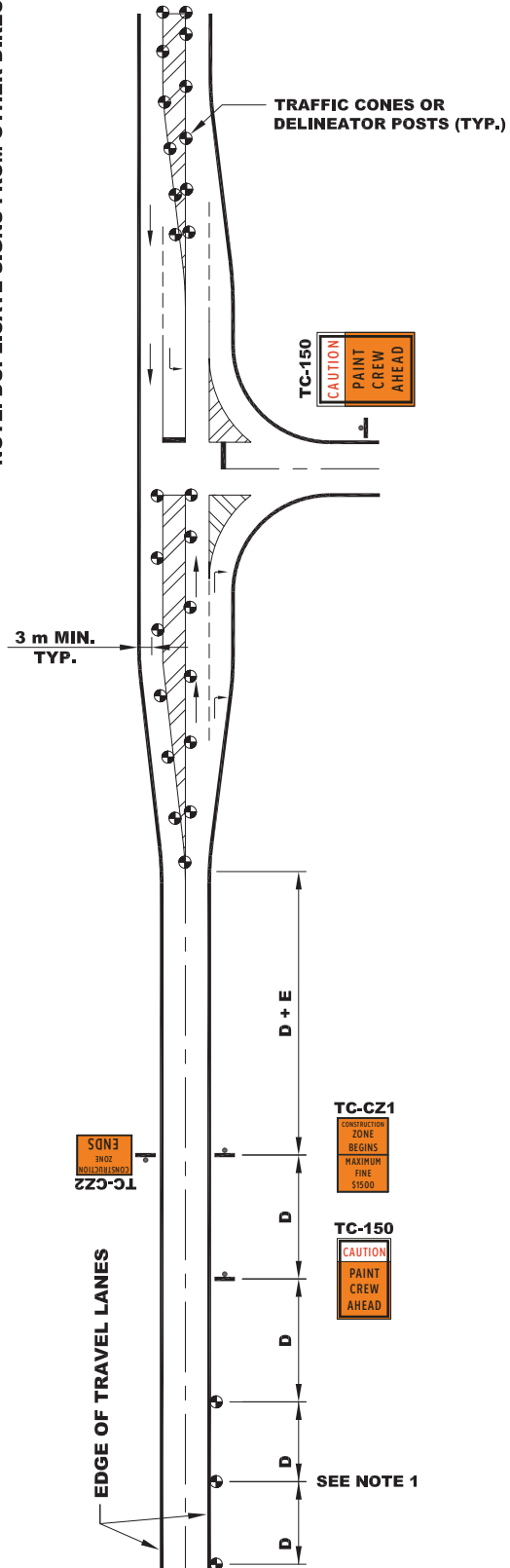

WORK ZONE DIMENSIONS FOR PAINTING CENTER CROSS HATCHING FOR 2 WAY TRAFFIC SPEED LIMIT < OR = TO 60 km/h						
NORMAL POSTED REGULATORY SPEED						
DIMENSION (m)	50					
A	30					
B	5/8					
C	30					
D	50					
E	35					

- POSTED SPEED IS EXISTING SPEED LIMIT (km/h)
- A - TAPER LANE WHEN NO LANE CONTROL PRESENT
 - B - MAX. DELINEATOR SPACING IN TAPER/WORK ZONE
 - C - TRAFFIC CONTROL PERSON SETBACK (m)
 - D - DISTANCE BETWEEN CONSTRUCTION SIGNS
 - E - BUFFER AREA LENGTH BETWEEN TAPER AND WORK ZONE

NOTES

1. THREE CONES TO BE PLACED IN ADVANCE OF SIGNS AS SHOWN, EITHER ALONG THE SHOULDER OR CENTERLINE.
2. ALL PERSONNEL WORKING ON OR NEAR THE ROADWAY MUST WEAR REQUIRED PERSONAL PROTECTIVE EQUIPMENT.
3. TRAFFIC CONES ARE TO BE USED TO DEFINE ALL INDIVIDUAL WORK ZONES OR WHERE WET PAINT EXISTS AND TO CHANNELIZE TRAFFIC AS REQUIRED WITH WELL TAPERED ENDS AS SHOWN IN EXAMPLE ABOVE. CONE PLACEMENT MUST BE AS PER THE CONSTRUCTION DISTANCE TABLE ABOVE AND ON PAGE 799-1, INCLUDING TAPERS. PLACE CONES AFTER PAINTING COMPLETED.
4. TWO ORANGE FLAGS TO BE MOUNTED ON EACH SIGN STAND.
5. THE FLAGPERSON AND FLAGPERSON SIGN (TC-21) TO BE PLACED WHEN AND WHERE REQUIRED.
6. WHEN PAINTING LANES, TRAFFIC MUST BE ALLOWED A THROUGH LANE AT ALL TIMES WITH A MINIMUM WIDTH OF 3 m, PAINTED AREAS MUST BE COMPLETELY CLOSED TO TRAFFIC.
7. DUPLICATE SIGNS FROM OTHER DIRECTION.

771-7

TRAFFIC CONTROL MANUAL

2018

NOTE: DUPLICATE SIGNS FROM OTHER DIRECTION.

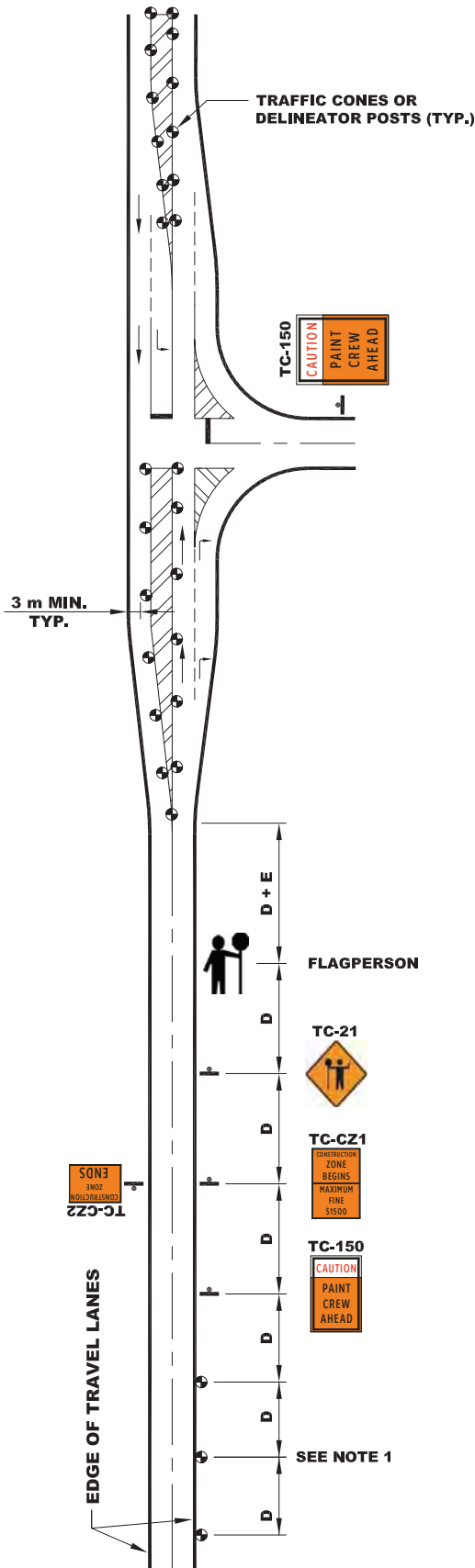

WORK ZONE DIMENSIONS FOR PAINTING CENTER CROSS HATCHING FOR 2 WAY TRAFFIC SPEED LIMIT < OR = TO 60 km/h

DIMENSION (m)	NORMAL POSTED REGULATORY SPEED				
	50	60	70	80	90
A	30				
B	5/8				
C	30				
D	50				
E	35				

POSTED SPEED IS EXISTING SPEED LIMIT (km/h)

A - TAPER LANE WHEN NO LANE CONTROL PRESENT

B - MAX. DELINEATOR SPACING IN TAPER/WORK ZONE

C - TRAFFIC CONTROL PERSON SETBACK (m)

D - DISTANCE BETWEEN CONSTRUCTION SIGNS

E - BUFFER AREA LENGTH BETWEEN TAPER AND WORK ZONE

NOTES

- THREE CONES TO BE PLACED IN ADVANCE OF SIGNS AS SHOWN, EITHER ALONG THE SHOULDER OR CENTERLINE.
- ALL PERSONNEL WORKING ON OR NEAR THE ROADWAY MUST WEAR REQUIRED PERSONAL PROTECTIVE EQUIPMENT.
- TRAFFIC CONES ARE TO BE USED TO DEFINE ALL INDIVIDUAL WORK ZONES OR WHERE WET PAINT EXISTS AND TO CHANNELIZE TRAFFIC AS REQUIRED WITH WELL TAPERED ENDS AS SHOWN IN EXAMPLE ABOVE. CONE PLACEMENT MUST BE AS PER THE CONSTRUCTION DISTANCE TABLE ABOVE AND ON PAGE 799-1, INCLUDING TAPERS. PLACE CONES AFTER PAINTING COMPLETED.
- TWO ORANGE FLAGS TO BE MOUNTED ON EACH SIGN STAND.
- THE FLAGPERSON AND FLAGPERSON SIGN (TC-21) TO BE PLACED WHEN AND WHERE REQUIRED.
- WHEN PAINTING LANES, TRAFFIC MUST BE ALLOWED A THROUGH LANE AT ALL TIMES WITH A MINIMUM WIDTH OF 3 m, PAINTED AREAS MUST BE COMPLETELY CLOSED TO TRAFFIC.
- DUPLICATE SIGNS FROM OTHER DIRECTION.

771-7F



TRANSPORTATION AND WORKS
HIGHWAY DESIGN DIVISION

LINE PAINTING PROCEDURES PAINTING CENTER CROSS HATCHING SPEED LIMIT < 60 km/h WITH FLAGPERSONS

DRAWN BY: G. Clarke

DATE: Rev June 2018

NOT TO SCALE

TRAFFIC CONTROL MANUAL

2018

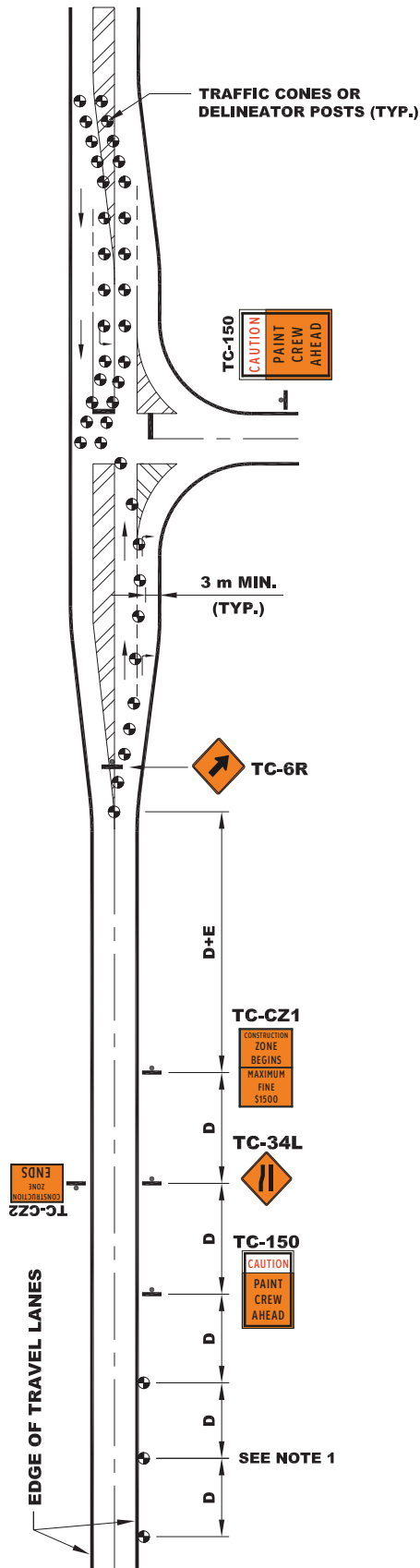

WORK ZONE DIMENSIONS FOR LEFT SIDE OF INTERSECTION PAINTING THROUGH LANE FOR 2 WAY TRAFFIC SPEED LIMIT < 60 km/h

DIMENSION (m)	NORMAL POSTED REGULATORY SPEED				
	50				
A	30				
B	5/8				
C	30				
D	50				
E	35				

POSTED SPEED IS EXISTING SPEED LIMIT (km/h)

A - TAPER LANE WHEN NO LANE CONTROL PRESENT

B - MAX. DELINEATOR SPACING IN TAPER/WORK ZONE

C - TRAFFIC CONTROL PERSON SETBACK (m)

D - DISTANCE BETWEEN CONSTRUCTION SIGNS

E - BUFFER AREA LENGTH BETWEEN TAPER AND WORK ZONE

NOTES

- THREE CONES TO BE PLACED IN ADVANCE OF SIGNS, AS SHOWN, EITHER ALONG SHOULDER OR CENTERLINE.
- ALL PERSONNEL WORKING ON OR NEAR THE ROADWAY MUST WEAR REQUIRED PERSONAL PROTECTIVE EQUIPMENT.
- TRAFFIC CONES ARE TO BE USED TO DEFINE ALL INDIVIDUAL WORK ZONES OR WHERE WET PAINT EXISTS AND TO CHANNELIZE TRAFFIC AS REQUIRED WITH WELL TAPERED ENDS AS SHOWN IN EXAMPLE ABOVE. CONE PLACEMENT MUST BE AS PER THE CONSTRUCTION DISTANCE TABLE ABOVE AND ON PAGE 799-1, INCLUDING TAPERS.
- TWO ORANGE FLAGS TO BE MOUNTED ON EACH SIGN STAND.
- THE FLAGPERSON AND FLAGPERSON SIGN (TC-21) TO BE PLACED WHEN AND WHERE REQUIRED.
- WHEN PAINTING LANES, TRAFFIC, MUST BE ALLOWED A THROUGH LANE AT ALL TIMES WITH A MINIMUM WIDTH OF 3 m, PAINTED AREAS MUST BE COMPLETELY CLOSED TO TRAFFIC.
- DUPLICATE SIGNS FROM OTHER DIRECTION. (SEE 771-8A)

771-8



TRANSPORTATION AND WORKS
HIGHWAY DESIGN DIVISION

LINE PAINTING PROCEDURES PAINTING IN THROUGH LANE (LEFT SIDE) SPEED LIMIT < 60 km/h

DRAWN BY: G. Clarke

DATE: Rev June 2018

NOT TO SCALE

TRAFFIC CONTROL MANUAL

2018

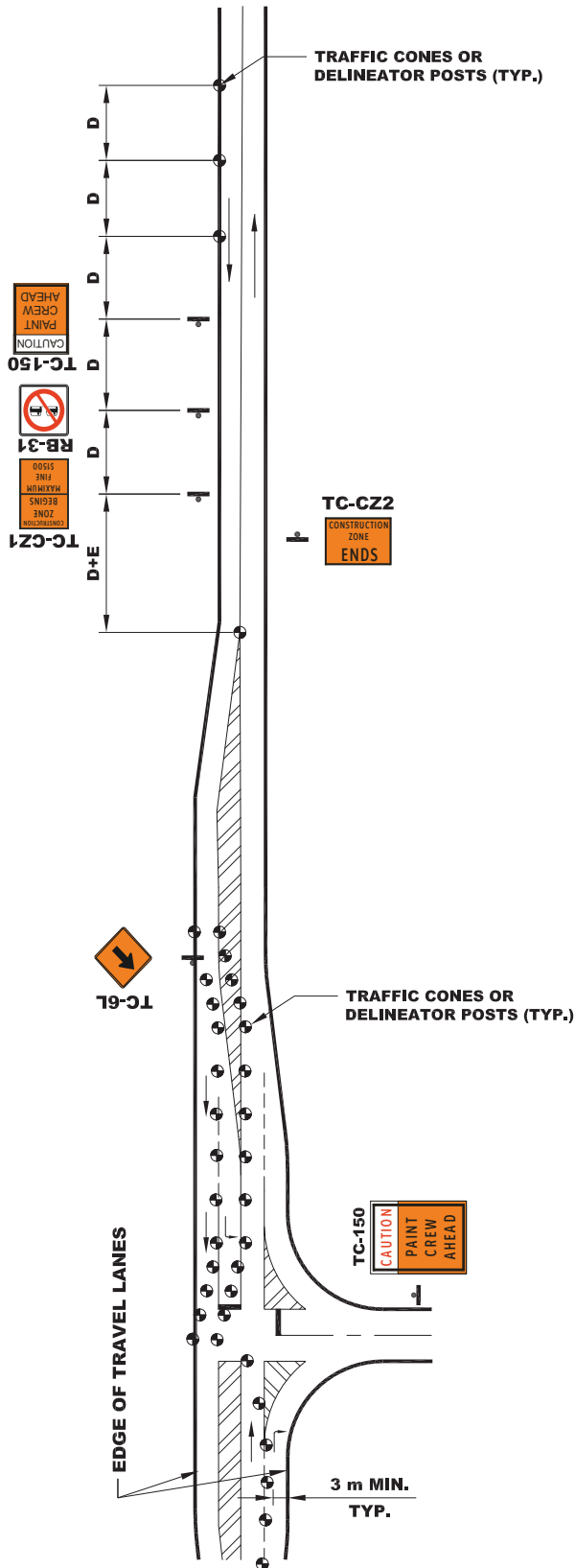

WORK ZONE DIMENSIONS FOR RIGHT SIDE OF INTERSECTION PAINTING IN THROUGH LANE FOR 2 WAY TRAFFIC SPEED LIMIT < 60 km/h						
DIMENSION (m)	NORMAL POSTED REGULATORY SPEED					
		50				
A	30					
B	5/8					
C	30					
D	50					
E	35					

POSTED SPEED IS EXISTING SPEED LIMIT (km/h)

A - TAPER LANE WHEN NO LANE CONTROL PRESENT

B - MAX. DELINEATOR SPACING IN TAPER/WORK ZONE

C - TRAFFIC CONTROL PERSON SETBACK (m)

D - DISTANCE BETWEEN CONSTRUCTION SIGNS

E - BUFFER AREA LENGTH BETWEEN TAPER AND WORK ZONE

NOTES

- THREE CONES TO BE PLACED IN ADVANCE OF SIGNS, AS SHOWN, EITHER ALONG SHOULDER OR CENTERLINE.
- ALL PERSONNEL WORKING ON OR NEAR THE ROADWAY MUST WEAR REQUIRED PERSONAL PROTECTIVE EQUIPMENT.
- TRAFFIC CONES ARE TO BE USED TO DEFINE ALL INDIVIDUAL WORK ZONES OR WHERE WET PAINT EXISTS AND TO CHANNELIZE TRAFFIC AS REQUIRED WITH WELL TAPERED ENDS AS SHOWN IN EXAMPLE ABOVE. CONE PLACEMENT MUST BE AS PER THE CONSTRUCTION DISTANCE TABLE ABOVE AND ON PAGE 799-1, INCLUDING TAPERS.
- TWO ORANGE FLAGS TO BE MOUNTED ON EACH SIGN STAND.
- THE FLAGPERSON AND FLAGPERSON SIGN (TC-21) TO BE PLACED WHEN AND WHERE REQUIRED.
- WHEN PAINTING LANES, TRAFFIC, MUST BE ALLOWED A THROUGH LANE AT ALL TIMES WITH A MINIMUM WIDTH OF 3 m, PAINTED AREAS MUST BE COMPLETELY CLOSED TO TRAFFIC.
- DUPLICATE SIGNS FROM OTHER DIRECTION. (SEE 771-8)

771-8A



TRANSPORTATION AND WORKS
HIGHWAY DESIGN DIVISION

LINE PAINTING PROCEDURES PAINTING IN THROUGH LANE (RIGHT SIDE) SPEED LIMIT < 60 km/h

DRAWN BY: G. Clarke

DATE: Rev June 2018

NOT TO SCALE

TRAFFIC CONTROL MANUAL 2018

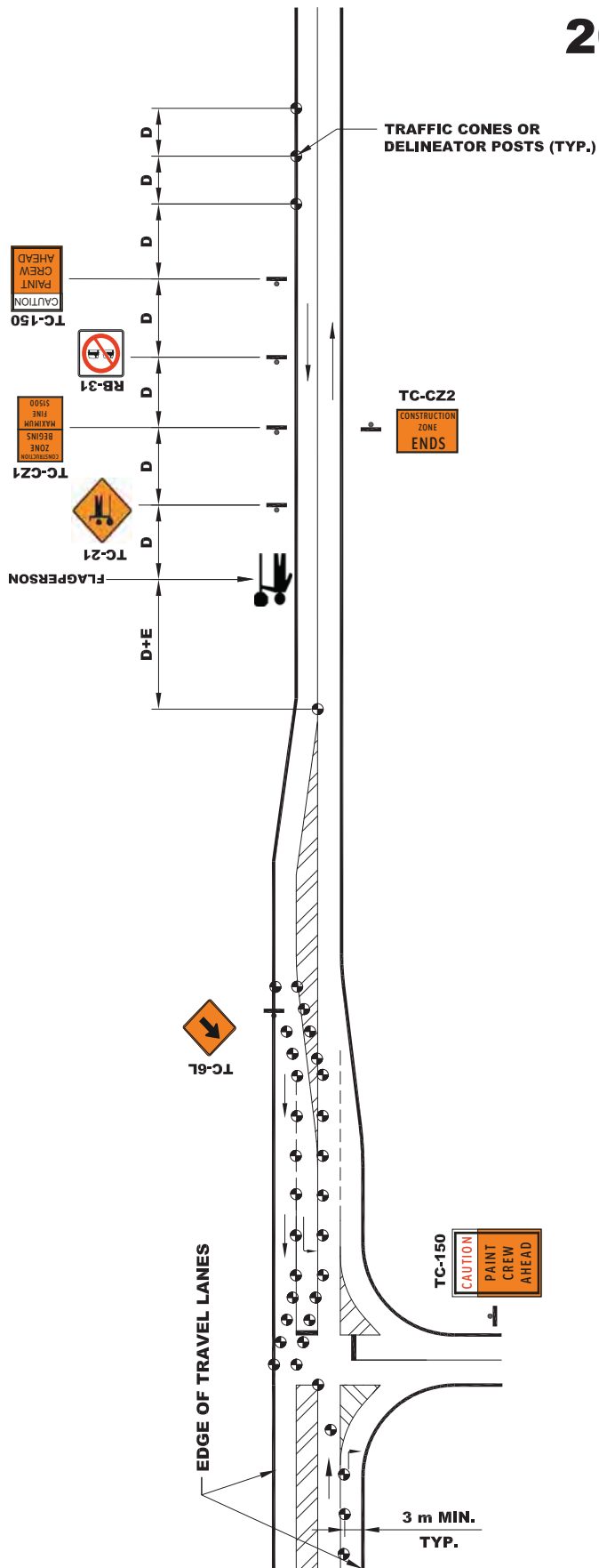

WORK ZONE DIMENSIONS FOR RIGHT SIDE OF INTERSECTION PAINTING IN THROUGH LANE 2 WAY TRAFFIC SPEED LIMIT < 60 km/h WITH FLAGPERSONS

DIMENSION (m)	NORMAL POSTED REGULATORY SPEED				
	50				
A	30				
B	5/8				
C	30				
D	50				
E	35				

POSTED SPEED IS EXISTING SPEED LIMIT (km/h)

A - TAPER LANE WHEN NO LANE CONTROL PRESENT

B - MAX. DELINEATOR SPACING IN TAPER/WORK ZONE

C - TRAFFIC CONTROL PERSON SETBACK (m)

D - DISTANCE BETWEEN CONSTRUCTION SIGNS

E - BUFFER AREA LENGTH BETWEEN TAPER AND WORK ZONE

NOTES

- THREE CONES TO BE PLACED IN ADVANCE OF SIGNS, AS SHOWN, EITHER ALONG SHOULDER OR CENTERLINE.
- ALL PERSONNEL WORKING ON OR NEAR THE ROADWAY MUST WEAR REQUIRED PERSONAL PROTECTIVE EQUIPMENT.
- TRAFFIC CONES ARE TO BE USED TO DEFINE ALL INDIVIDUAL WORK ZONES OR WHERE WET PAINT EXISTS AND TO CHANNELIZE TRAFFIC AS REQUIRED WITH WELL TAPERED ENDS AS SHOWN IN EXAMPLE ABOVE. CONE PLACEMENT MUST BE AS PER THE CONSTRUCTION DISTANCE TABLE ABOVE AND ON PAGE 799-1, INCLUDING TAPERS.
- TWO ORANGE FLAGS TO BE MOUNTED ON EACH SIGN STAND.
- THE FLAGPERSON AND FLAGPERSON SIGN (TC-21) TO BE PLACED WHEN AND WHERE REQUIRED.
- WHEN PAINTING LANES, TRAFFIC, MUST BE ALLOWED A THROUGH LANE AT ALL TIMES WITH A MINIMUM WIDTH OF 3 m, PAINTED AREAS MUST BE COMPLETELY CLOSED TO TRAFFIC.
- DUPLICATE SIGNS FROM OTHER DIRECTION.(SEE 771-8F)
- LINE OF SIGHT SHALL BE MAINTAINED BETWEEN FLAGPERSONS. REFER TO DRAWINGS 757-1 AND 757-2.

771-8AF



TRANSPORTATION AND WORKS
HIGHWAY DESIGN DIVISION

LINE PAINTING PROCEDURES PAINTING IN THROUGH LANE (RIGHT SIDE) SPEED LIMIT < 60 km/h WITH FLAGPERSONS

DRAWN BY: G. Clarke

DATE: Rev June 2018

NOT TO SCALE

TRAFFIC CONTROL MANUAL 2018

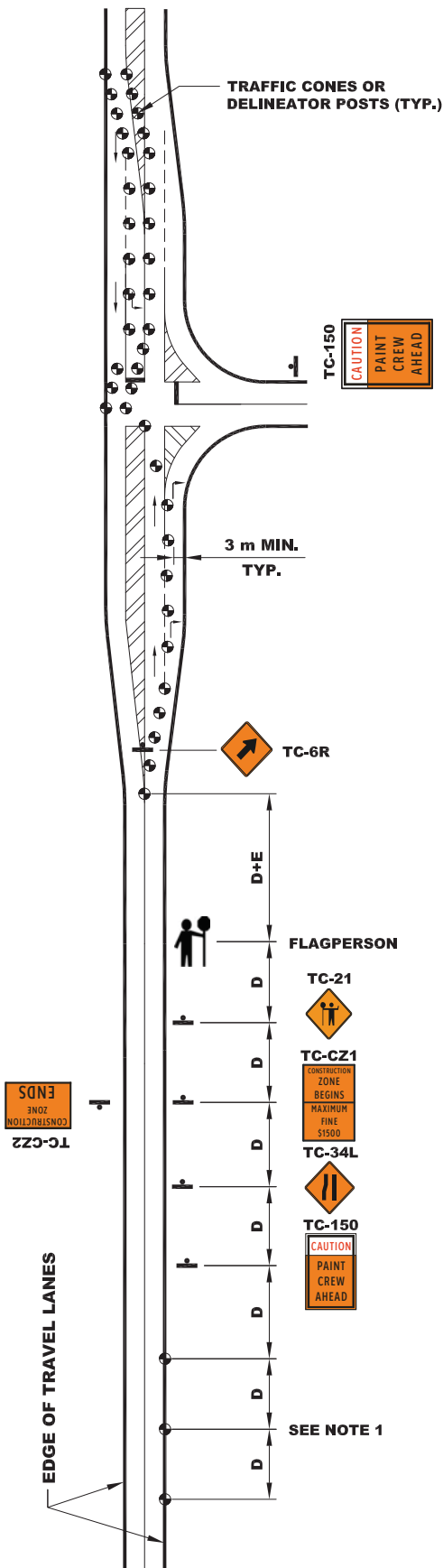

WORK ZONE DIMENSIONS FOR LEFT SIDE OF INTERSECTION PAINTING IN THROUGH LANE 2 WAY TRAFFIC SPEED LIMIT < 60 km/h WITH FLAGPERSONS

DIMENSION (m)	NORMAL POSTED REGULATORY SPEED				
	50				
A	30				
B	5/8				
C	30				
D	50				
E	35				

POSTED SPEED IS EXISTING SPEED LIMIT (km/h)

A - TAPER LANE WHEN NO LANE CONTROL PRESENT

B - MAX. DELINEATOR SPACING IN TAPER/WORK ZONE

C - TRAFFIC CONTROL PERSON SETBACK (m)

D - DISTANCE BETWEEN CONSTRUCTION SIGNS

E - BUFFER AREA LENGTH BETWEEN TAPER AND WORK ZONE

NOTES

- THREE CONES TO BE PLACED IN ADVANCE OF SIGNS, AS SHOWN, EITHER ALONG SHOULDER OR CENTERLINE.
- ALL PERSONNEL WORKING ON OR NEAR THE ROADWAY MUST WEAR REQUIRED PERSONAL PROTECTIVE EQUIPMENT.
- TRAFFIC CONES ARE TO BE USED TO DEFINE ALL INDIVIDUAL WORK ZONES OR WHERE WET PAINT EXISTS AND TO CHANNELIZE TRAFFIC AS REQUIRED WITH WELL TAPERED ENDS AS SHOWN IN EXAMPLE ABOVE. CONE PLACEMENT MUST BE AS PER THE CONSTRUCTION DISTANCE TABLE ABOVE AND ON PAGE 799-1, INCLUDING TAPERS.
- TWO ORANGE FLAGS TO BE MOUNTED ON EACH SIGN.
- THE FLAGPERSON AND FLAGPERSON SIGN (TC-21) TO BE PLACED WHEN AND WHERE REQUIRED.
- WHEN PAINTING LANES, TRAFFIC, MUST BE ALLOWED A THROUGH LANE AT ALL TIMES WITH A MINIMUM WIDTH OF 3 m, PAINTED AREAS MUST BE COMPLETELY CLOSED TO TRAFFIC.
- DUPLICATE SIGNS FROM OTHER DIRECTION. (SEE 771-8AF)
- LINE OF SIGHT SHALL BE MAINTAINED BETWEEN FLAGPERSONS. REFER TO DRAWINGS 757-1 AND 757-2.

771-8F

TRAFFIC CONTROL MANUAL

2018

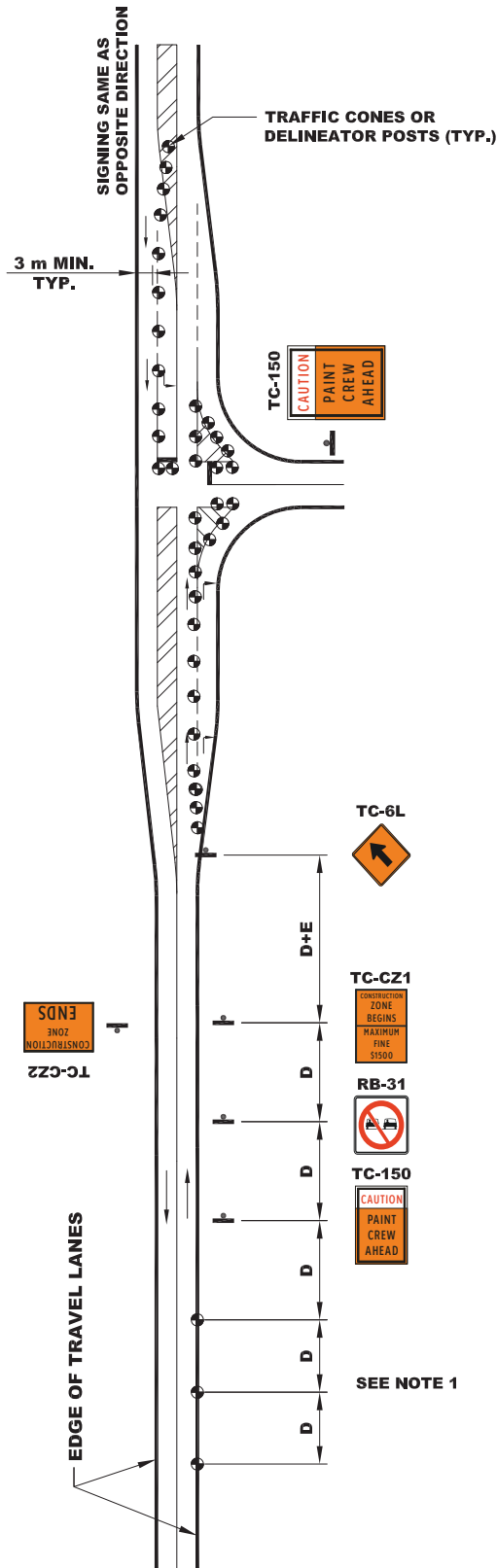

WORK ZONE DIMENSIONS FOR LEFT SIDE OF INTERSECTION PAINTING TURNING ARROWS, STOP BARS AND ISLANDS FOR 2 WAY TRAFFIC SPEED LIMIT < 60 km/h

DIMENSION (m)	NORMAL POSTED REGULATORY SPEED				
	50				
A	30				
B	5/8				
C	30				
D	50				
E	35				

POSTED SPEED IS EXISTING SPEED LIMIT (km/h)

A - TAPER LANE WHEN NO LANE CONTROL PRESENT

B - MAX. DELINEATOR SPACING IN TAPER/WORK ZONE

C - TRAFFIC CONTROL PERSON SETBACK (m)

D - DISTANCE BETWEEN CONSTRUCTION SIGNS

E - BUFFER AREA LENGTH BETWEEN TAPER AND WORK ZONE

NOTES

- THREE CONES TO BE PLACED IN ADVANCE OF SIGNS, AS SHOWN, EITHER ALONG THE SHOULDER OR CENTERLINE.
- ALL PERSONNEL WORKING ON OR NEAR THE ROADWAY MUST WEAR REQUIRED PERSONAL PROTECTIVE EQUIPMENT.
- TRAFFIC CONES ARE TO BE USED TO DEFINE ALL INDIVIDUAL WORK ZONES OR WHERE WET PAINT EXISTS AND TO CHANNELIZE TRAFFIC AS REQUIRED WITH WELL TAPERED ENDS AS SHOWN IN EXAMPLE ABOVE. CONE PLACEMENT MUST BE AS PER THE CONSTRUCTION DISTANCE TABLE SHOWN ABOVE AND ON PAGE 799-1, INCLUDING TAPERS. PLACE CONES ON ISLANDS AND STOP BARS AFTER PAINTING COMPLETED.
- TWO ORANGE FLAGS TO BE MOUNTED ON EACH SIGN STAND.
- THE FLAGPERSON AND FLAGPERSON SIGN (TC-21) TO BE PLACED WHEN AND WHERE REQUIRED.
- WHEN PAINTING LANES, TRAFFIC, MUST BE ALLOWED A THROUGH LANE AT ALL TIMES WITH A MINIMUM WIDTH OF 3 m, PAINTED AREAS MUST BE COMPLETELY CLOSED TO TRAFFIC.
- DUPLICATE SIGNS FROM OTHER DIRECTION. (SEE 771-9A)

771-9



TRANSPORTATION AND WORKS
HIGHWAY DESIGN DIVISION

LINE PAINTING PROCEDURES
PAINTING TURNING ARROWS, STOP BARS AND ISLANDS (LEFT SIDE)
SPEED LIMIT < 60 km/h

DRAWN BY: G. Clarke

DATE: Rev June 2018

NOT TO SCALE

TRAFFIC CONTROL MANUAL

2018

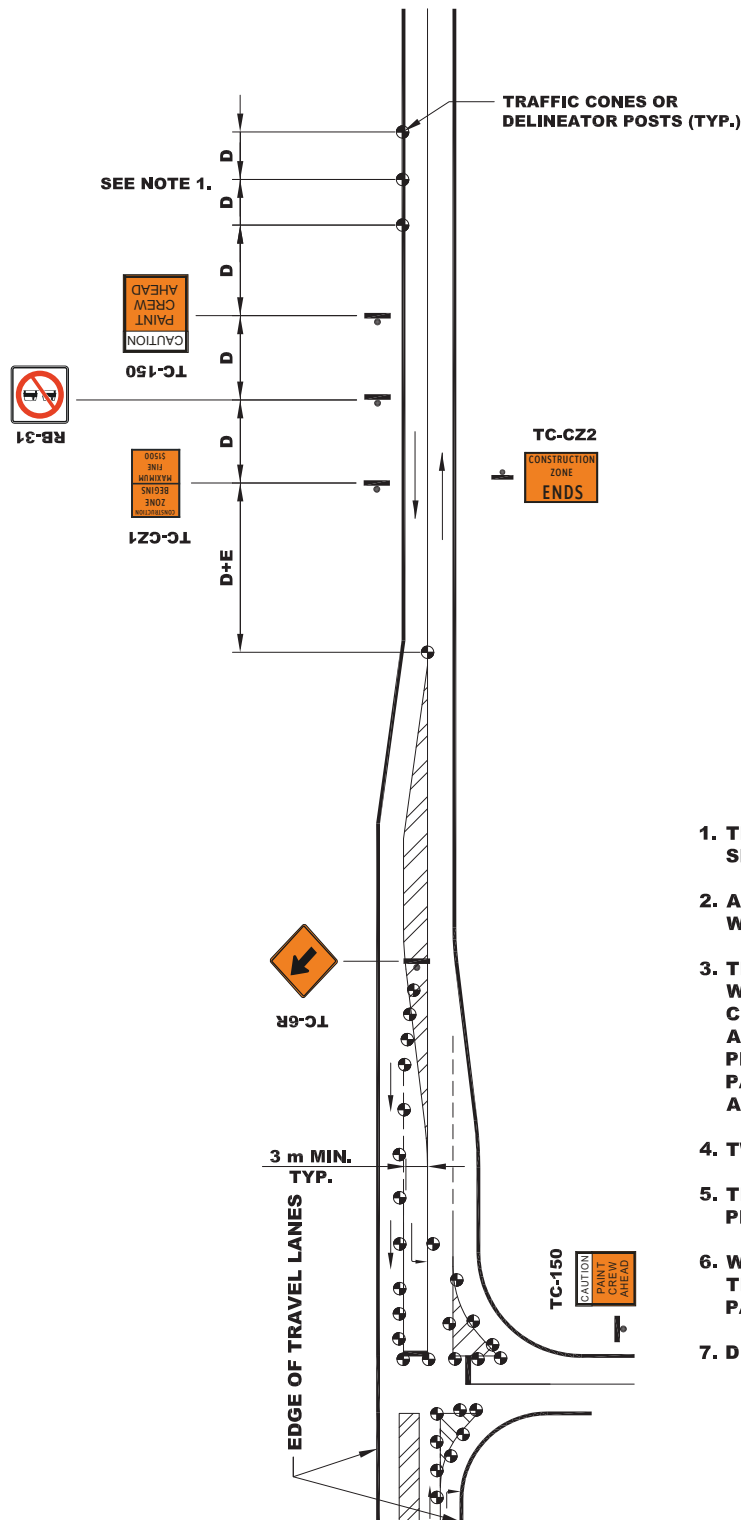

WORK ZONE DIMENSIONS FOR RIGHT SIDE OF INTERSECTION PAINTING TURNING ARROWS, STOP BARS AND ISLANDS FOR 2 WAY TRAFFIC SPEED LIMIT < 60 km/h

DIMENSION (m)	NORMAL POSTED REGULATORY SPEED				
	50	60	70	80	90
A	30				
B	5/8				
C	30				
D	50				
E	35				

- POSTED SPEED IS EXISTING SPEED LIMIT (km/h)
- A - TAPER LANE WHEN NO LANE CONTROL PRESENT
 - B - MAX. DELINEATOR SPACING IN TAPER/WORK ZONE
 - C - TRAFFIC CONTROL PERSON SETBACK (m)
 - D - DISTANCE BETWEEN CONSTRUCTION SIGNS
 - E - BUFFER AREA LENGTH BETWEEN TAPER AND WORK ZONE

NOTES

1. THREE CONES TO BE PLACED IN ADVANCE OF SIGNS, AS SHOWN, EITHER ALONG THE SHOULDER OR CENTERLINE.
2. ALL PERSONNEL WORKING ON OR NEAR THE ROADWAY MUST WEAR REQUIRED PERSONAL PROTECTIVE EQUIPMENT.
3. TRAFFIC CONES ARE TO BE USED TO DEFINE ALL INDIVIDUAL WORK ZONES OR WHERE WET PAINT EXISTS AND TO CHANNELIZE TRAFFIC AS REQUIRED WITH WELL TAPERED ENDS AS SHOWN IN EXAMPLE ABOVE. CONE PLACEMENT MUST BE AS PER THE CONSTRUCTION DISTANCE TABLE ABOVE AND ON PAGE 799-1, INCLUDING TAPERS. PLACE CONES ON ISLANDS AND STOP BARS AFTER PAINTING COMPLETED.
4. TWO ORANGE FLAGS TO BE MOUNTED ON EACH SIGN STAND.
5. THE FLAGPERSON AND FLAGPERSON SIGN (TC-21) TO BE PLACED WHEN AND WHERE REQUIRED.
6. WHEN PAINTING LANES, TRAFFIC, MUST BE ALLOWED A THROUGH LANE AT ALL TIMES WITH A MINIMUM WIDTH OF 3 m, PAINTED AREAS MUST BE COMPLETELY CLOSED TO TRAFFIC.
7. DUPLICATE SIGNS FROM OTHER DIRECTION.(SEE 771-9)

771-9A

TRAFFIC CONTROL MANUAL

2018

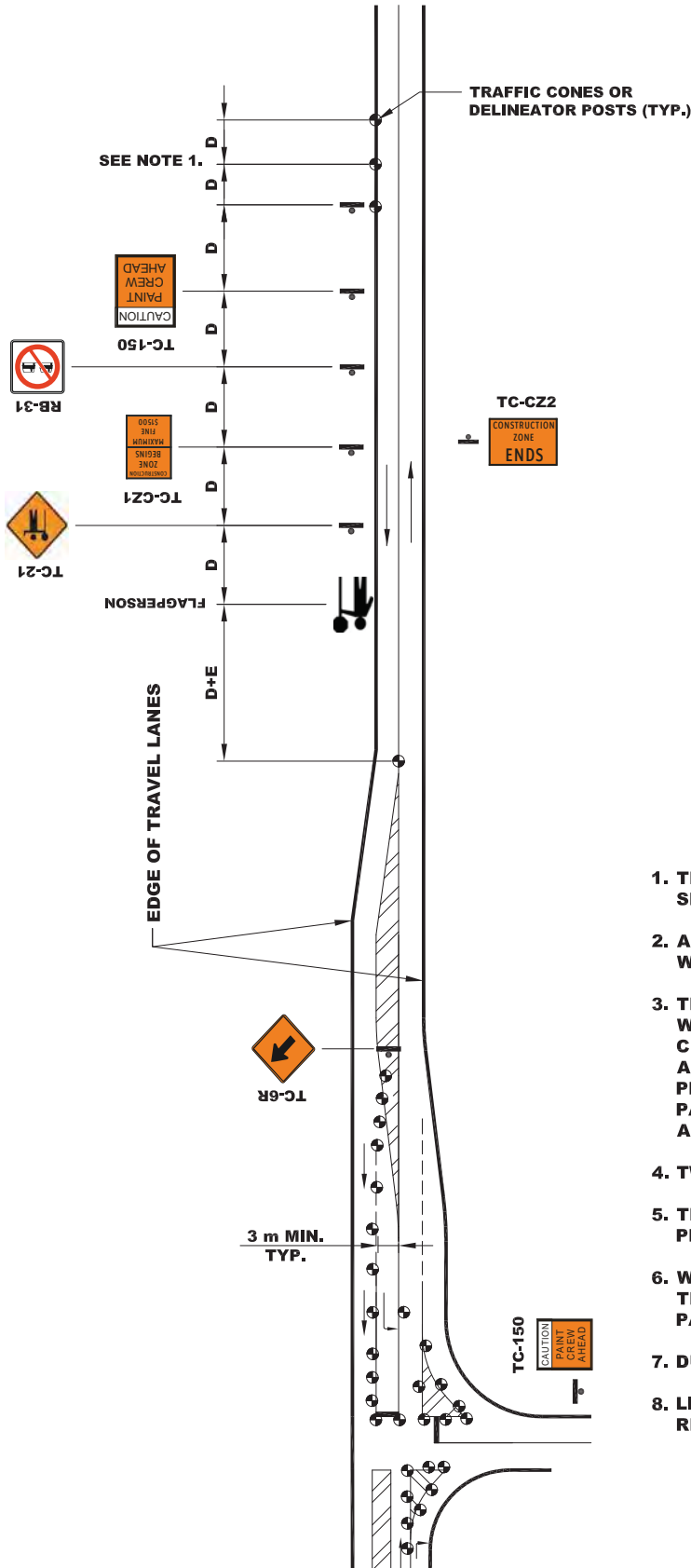

WORK ZONE DIMENSIONS FOR RIGHT SIDE OF INTERSECTION PAINTING TURNING ARROWS, STOP BARS AND ISLANDS FOR 2 WAY TRAFFIC SPEED LIMIT < 60 km/h

DIMENSION (m)	NORMAL POSTED REGULATORY SPEED				
	50				
A	30				
B	5/8				
C	30				
D	50				
E	35				

POSTED SPEED IS EXISTING SPEED LIMIT (km/h)

A - TAPER LANE WHEN NO LANE CONTROL PRESENT

B - MAX. DELINEATOR SPACING IN TAPER/WORK ZONE

C - TRAFFIC CONTROL PERSON SETBACK (m)

D - DISTANCE BETWEEN CONSTRUCTION SIGNS

E - BUFFER AREA LENGTH BETWEEN TAPER AND WORK ZONE

NOTES

1. THREE CONES TO BE PLACED IN ADVANCE OF SIGNS, AS SHOWN, EITHER ALONG THE SHOULDER OR CENTERLINE.
2. ALL PERSONNEL WORKING ON OR NEAR THE ROADWAY MUST WEAR REQUIRED PERSONAL PROTECTIVE EQUIPMENT.
3. TRAFFIC CONES ARE TO BE USED TO DEFINE ALL INDIVIDUAL WORK ZONES OR WHERE WET PAINT EXISTS AND TO CHANNELIZE TRAFFIC AS REQUIRED WITH WELL TAPERED ENDS AS SHOWN IN EXAMPLE ABOVE. CONE PLACEMENT MUST BE AS PER THE CONSTRUCTION DISTANCE TABLE ABOVE AND ON PAGE 799-1, INCLUDING TAPERS. PLACE CONES ON ISLANDS AND STOP BARS AFTER PAINTING COMPLETED.
4. TWO ORANGE FLAGS TO BE MOUNTED ON EACH SIGN STAND.
5. THE FLAGPERSON AND FLAGPERSON SIGN (TC-21) TO BE PLACED WHEN AND WHERE REQUIRED.
6. WHEN PAINTING LANES, TRAFFIC, MUST BE ALLOWED A THROUGH LANE AT ALL TIMES WITH A MINIMUM WIDTH OF 3 m, PAINTED AREAS MUST BE COMPLETELY CLOSED TO TRAFFIC.
7. DUPLICATE SIGNS FROM OTHER DIRECTION. (SEE 771-9F)
8. LINE OF SIGHT SHALL BE MAINTAINED BETWEEN FLAGPERSONS. REFER TO DRAWINGS 757-1 AND 757-2.

771-9AF



TRANSPORTATION AND WORKS
HIGHWAY DESIGN DIVISION

LINE PAINTING PROCEDURES

PAINTING TURNING ARROWS, STOP BARS AND ISLANDS (RIGHT SIDE)
SPEED LIMIT < 60 km/h WITH FLAGPERSONS

DRAWN BY: G. Clarke

DATE: Rev June 2018

NOT TO SCALE

TRAFFIC CONTROL MANUAL 2018

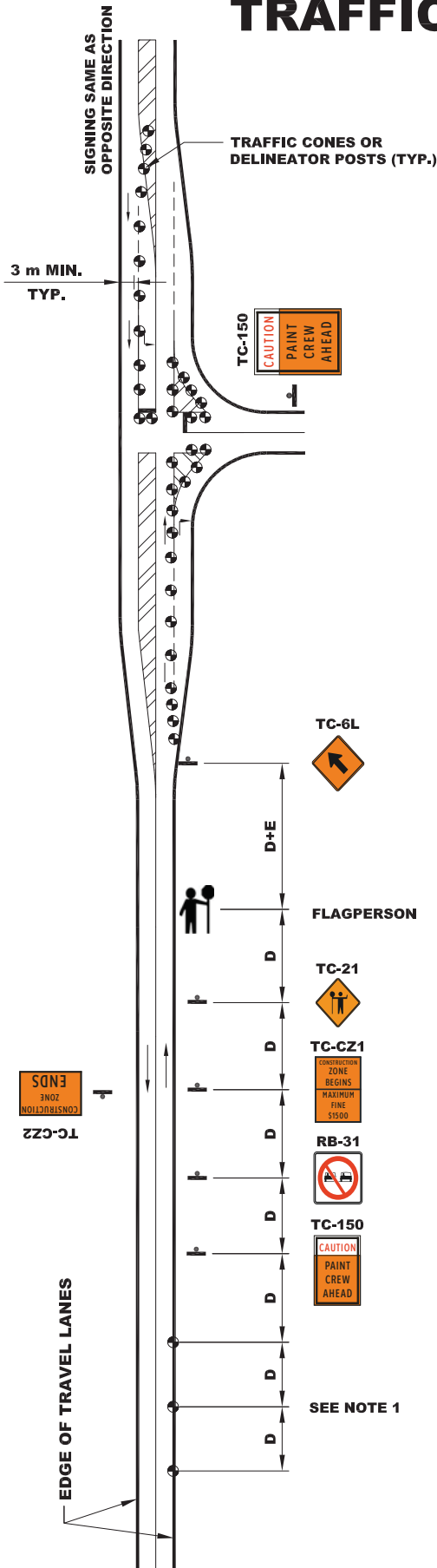

WORK ZONE DIMENSIONS FOR LEFT SIDE OF INTERSECTION PAINTING TURNING ARROWS, STOP BARS AND ISLANDS FOR 2 WAY TRAFFIC SPEED LIMIT < 60 km/h

DIMENSION (m)	NORMAL POSTED REGULATORY SPEED				
	50				
A	30				
B	5/8				
C	30				
D	50				
E	35				

POSTED SPEED IS EXISTING SPEED LIMIT (km/h)

A - TAPER LANE WHEN NO LANE CONTROL PRESENT

B - MAX. DELINEATOR SPACING IN TAPER/WORK ZONE

C - TRAFFIC CONTROL PERSON SETBACK (m)

D - DISTANCE BETWEEN CONSTRUCTION SIGNS

E - BUFFER AREA LENGTH BETWEEN TAPER AND WORK ZONE

NOTES

- THREE CONES TO BE PLACED IN ADVANCE OF SIGNS, AS SHOWN, EITHER ALONG THE SHOULDER OR CENTERLINE.
- ALL PERSONNEL WORKING ON OR NEAR THE ROADWAY MUST WEAR REQUIRED PERSONAL PROTECTIVE EQUIPMENT.
- TRAFFIC CONES ARE TO BE USED TO DEFINE ALL INDIVIDUAL WORK ZONES OR WHERE WET PAINT EXISTS AND TO CHANNELIZE TRAFFIC AS REQUIRED WITH WELL TAPERED ENDS AS SHOWN IN EXAMPLE ABOVE. CONE PLACEMENT MUST BE AS PER THE CONSTRUCTION DISTANCE TABLE SHOWN ABOVE AND ON PAGE 799-1, INCLUDING TAPERS. PLACE CONES ON ISLANDS AND STOP BARS AFTER PAINTING COMPLETED.
- TWO ORANGE FLAGS TO BE MOUNTED ON EACH SIGN STAND.
- THE FLAGPERSON AND FLAGPERSON SIGN (TC-21) TO BE PLACED WHEN AND WHERE REQUIRED.
- WHEN PAINTING LANES, TRAFFIC, MUST BE ALLOWED A THROUGH LANE AT ALL TIMES WITH A MINIMUM WIDTH OF 3 m, PAINTED AREAS MUST BE COMPLETELY CLOSED TO TRAFFIC.
- DUPLICATE SIGNS FROM OTHER DIRECTION. (SEE 771-9AF)

771-9F



TRANSPORTATION AND WORKS
HIGHWAY DESIGN DIVISION

LINE PAINTING PROCEDURES

PAINTING TURNING ARROWS, STOP BARS AND ISLANDS (LEFT SIDE)
SPEED LIMIT < 60 km/h WITH FLAGPERSONS

DRAWN BY: G. Clarke

DATE: Rev June 2018

NOT TO SCALE

TRAFFIC CONTROL MANUAL

2018

WORK ZONE DIMENSIONS FOR TARGETING PASSING LANES OR DOTTING ON CENTERLINE 2 WAY TRAFFIC						
NORMAL POSTED REGULATORY SPEED						
DIMENSION (m)	50	60	70	80	90	100
A	30	40	60	90	110	180
B	5/8	8/12	10/15	10/15	12/18	15/20
C	30	40	40	50	50	50
D	50	50	75	100	100	150
E	35	50	50	75	75	75

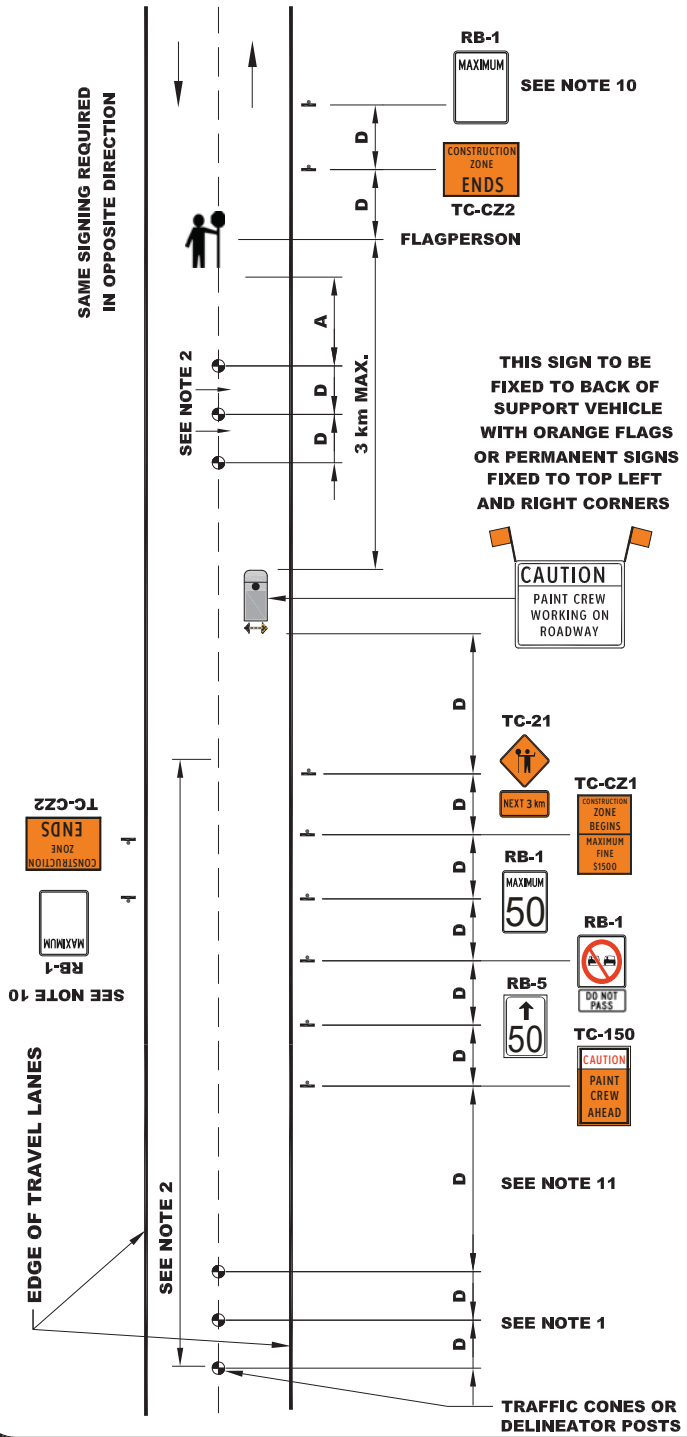

- POSTED SPEED IS EXISTING SPEED LIMIT (km/h)**
- A - TAPER LANE WHEN NO LANE CONTROL PRESENT**
 - B - MAX. DELINEATOR SPACING IN TAPER/WORK ZONE**
 - C - TRAFFIC CONTROL PERSON SETBACK (m)**
 - D - DISTANCE BETWEEN CONSTRUCTION SIGNS**
 - E - BUFFER AREA LENGTH BETWEEN TAPER AND WORK ZONE**

NOTES

1. A SEQUENCE OF THREE CONES TO BE PLACED IN ADVANCE OF THE SIGNS AS SHOWN, EITHER ALONG THE SHOULDER OR CENTERLINE.
2. REPEAT THE SERIES OF CONES ALONG THE CENTERLINE EVERY 500 m.
3. FLAGPERSON SHALL BE USED GOING BEHIND CREW MEMBERS WHO ARE MARKING PAVEMENT, TO WARN WORKERS OF HAZARDS FROM MOVING VEHICLES.
4. TOTAL WORKING DISTANCE SHALL NOT EXCEED 3 km.
5. CONES TO BE PLACED ON CENTER LINE EVERY 500 m TO REMIND MOTORISTS OF OPERATION PROCEEDING.
6. FLAGPERSON SHOULD BE EQUIPPED WITH A CUSTOMIZED PADDLE HAVING SLOW MARKINGS ON EACH SIDE.
7. ALL PERSONNEL WORKING ON OR NEAR THE ROADWAY MUST WEAR REQUIRED PERSONAL PROTECTIVE EQUIPMENT.
8. SIGN FOR PICKUP MUST BE CUSTOM MADE AT THE SIGN SHOP.
9. PERSONNEL SHOULD ALWAYS WALK IN THE LANE NEAREST THE PAINT TRUCK AND NOT CROSS INTO THE LANE OF THE OPPOSING TRAFFIC.
10. INSTALL AN RB-1 SPEED LIMIT SIGN TO DISPLAY THE NORMAL OPERATING SPEED LIMIT OF THE HIGHWAY.
11. WHEN NORMAL POSTED SPEED IS GREATER THAN 80 km/h VARIABLE MESSAGE SIGN.

NOTE:
IF NORMAL SPEED LIMIT IS <60 km/h
RB-5(50) & RB-1(50) NOT REQUIRED

771-10



TRANSPORTATION AND WORKS
HIGHWAY DESIGN DIVISION

LINE PAINTING PROCEDURES TARGETING OR DOTTING - TWO WAY TRAFFIC

TRAFFIC CONTROL MANUAL

2018

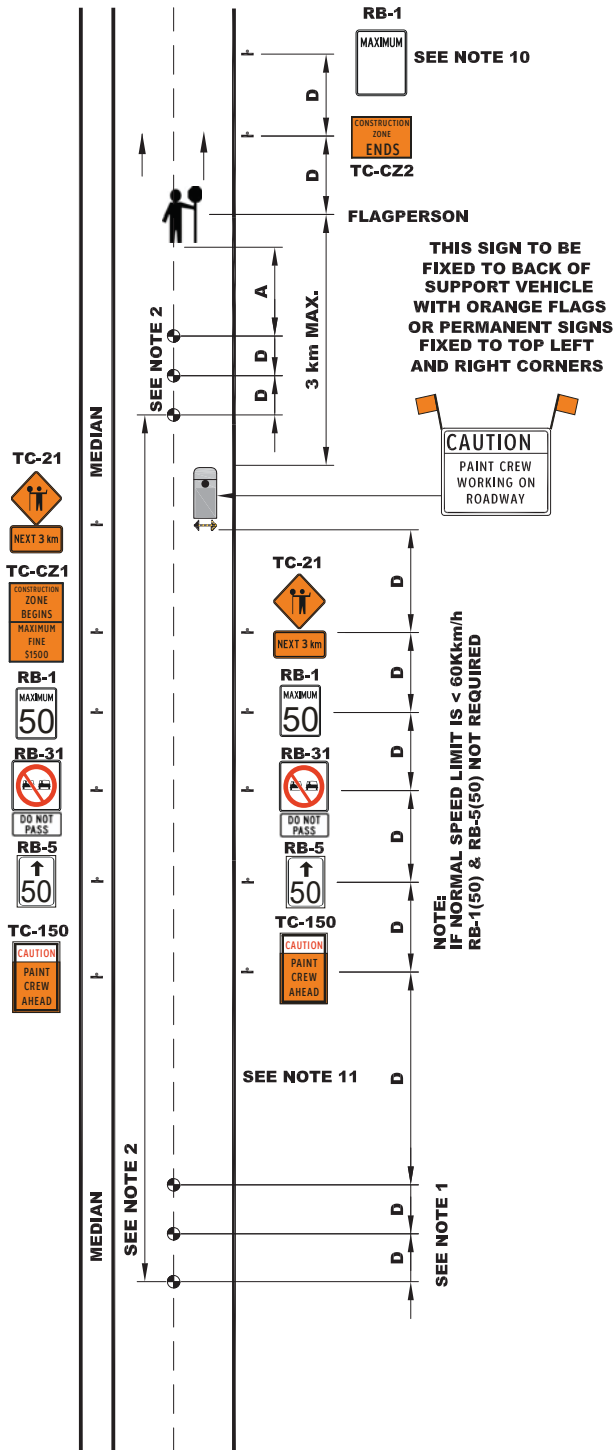

WORK ZONE DIMENSIONS FOR DOTTING ON DIVIDED HIGHWAY

DIMENSION (m)	NORMAL POSTED REGULATORY SPEED					
	50	60	70	80	90	100
A	30	40	60	90	110	180
B	5/8	8/12	10/15	10/15	12/18	15/20
C	30	40	40	50	50	50
D	50	50	75	100	100	150
E	35	50	50	75	75	75

POSTED SPEED IS EXISTING SPEED LIMIT (km/h)

- A - TAPER LANE WHEN NO LANE CONTROL PRESENT
- B - MAX. DELINEATOR SPACING IN TAPER/WORK ZONE
- C - TRAFFIC CONTROL PERSON SETBACK (m)
- D - DISTANCE BETWEEN CONSTRUCTION SIGNS
- E - BUFFER AREA LENGTH BETWEEN TAPER AND WORK ZONE

NOTES

1. A SEQUENCE OF THREE CONES TO BE PLACED IN ADVANCE OF THE SIGNS AS SHOWN, EITHER ALONG THE SHOULDER OR CENTERLINE.
2. REPEAT THE SERIES OF CONES ALONG THE CENTERLINE EVERY 500 m.
3. FLAGPERSON SHALL BE USED GOING BEHIND CREW MEMBERS WHO ARE MARKING PAVEMENT, TO WARN WORKERS OF HAZARDS FROM MOVING VEHICLES.
4. TOTAL WORKING DISTANCE SHALL NOT EXCEED 3 km.
5. CONES TO BE PLACED ON CENTER LINE EVERY 500 m TO REMIND MOTORISTS OF OPERATION PROCEEDING.
6. FLAGPERSON SHOULD BE EQUIPPED WITH A CUSTOMIZED PADDLE HAVING SLOW MARKINGS ON EACH SIDE.
7. ALL PERSONNEL WORKING ON OR NEAR THE ROADWAY MUST WEAR REQUIRED PERSONAL PROTECTIVE EQUIPMENT.
8. SIGN FOR PICKUP MUST BE CUSTOM MADE AT THE SIGN SHOP.
9. PERSONNEL SHOULD ALWAYS WALK IN THE LANE NEAREST THE PAINT TRUCK AND NOT CROSS INTO THE LANE OF THE OPPOSING TRAFFIC.
10. INSTALL AN RB-1 SPEED LIMIT SIGN TO DISPLAY THE NORMAL OPERATING SPEED LIMIT OF THE HIGHWAY.
11. VARIABLE MESSAGE SIGN IS RECOMMENDED.

771-11



TRANSPORTATION AND WORKS
HIGHWAY DESIGN DIVISION

LINE PAINTING PROCEDURES DOTTING ON DIVIDED HIGHWAY

DRAWN BY: G. Clarke

DATE: Rev June 2018

NOT TO SCALE

TRAFFIC CONTROL MANUAL 2018

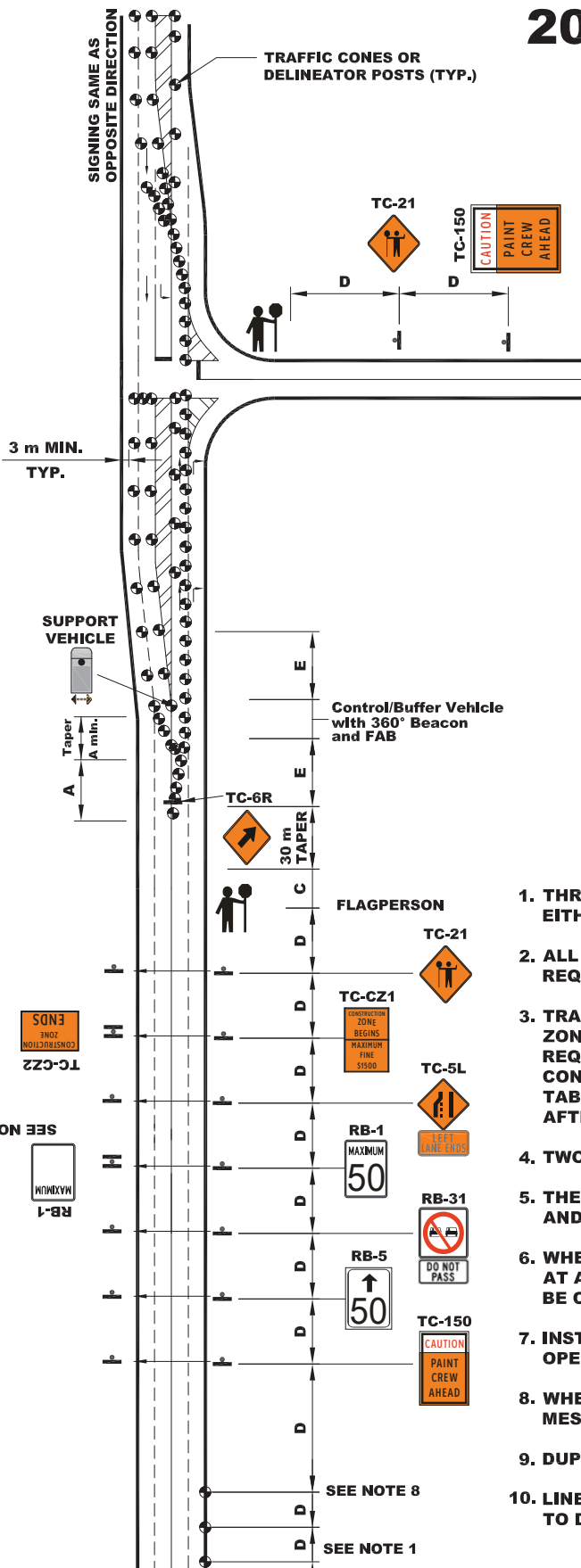

WORK ZONE DIMENSIONS FOR PAINTING CENTER CROSS HATCHING MULTIPLE LANES FOR 2 WAY TRAFFIC ALL SPEEDS						
DIMENSION (m)	NORMAL POSTED REGULATORY SPEED					
	50	60	70	80	90	100
A	30	40	60	90	110	180
B	5/8	8/12	10/15	10/15	12/18	15/20
C	30	40	40	50	50	50
D	50	50	75	100	100	150
E	35	50	50	75	75	75

POSTED SPEED IS EXISTING SPEED LIMIT (km/h)

A - TAPER LANE WHEN NO LANE CONTROL PRESENT

B - MAX. DELINEATOR SPACING IN TAPER/WORK ZONE

C - TRAFFIC CONTROL PERSON SETBACK (m)

D - DISTANCE BETWEEN CONSTRUCTION SIGNS

E - BUFFER AREA LENGTH BETWEEN TAPER AND WORK ZONE

NOTES

- THREE CONES TO BE PLACED IN ADVANCE OF SIGNS, AS SHOWN, EITHER ON THE SHOULDER OR ON THE CENTERLINE.
- ALL PERSONNEL WORKING ON OR NEAR THE ROADWAY MUST WEAR REQUIRED PERSONAL PROTECTIVE EQUIPMENT.
- TRAFFIC CONES ARE TO BE USED TO DEFINE ALL INDIVIDUAL WORK ZONES OR WHERE WET PAINT EXISTS AND TO CHANNELIZE TRAFFIC AS REQUIRED WITH WELL TAPERED ENDS AS SHOWN IN EXAMPLE ABOVE. CONE PLACEMENT MUST BE AS PER THE CONSTRUCTION DISTANCE TABLE ABOVE AND ON PAGE 799-1, INCLUDING TAPERS. PLACE CONES AFTER PAINTING COMPLETED.
- TWO ORANGE FLAGS TO BE MOUNTED ON EACH SIGN.
- THE FLAGPERSON AND FLAGPERSON SIGN (TC-21) TO BE PLACED WHEN AND WHERE REQUIRED.
- WHEN PAINTING LANES, TRAFFIC, MUST BE ALLOWED A THROUGH LANE AT ALL TIMES WITH A MINIMUM WIDTH OF 3 m. PAINTED AREAS MUST BE COMPLETELY CLOSED TO TRAFFIC.
- INSTALL AN RB-1 SPEED LIMIT SIGN TO DISPLAY THE NORMAL OPERATING SPEED LIMIT OF THE HIGHWAY.
- WHEN NORMAL POSTED SPEED IS GREATER THAN 80km/h VARIABLE MESSAGE SIGN IS RECOMMENDED.
- DUPLICATE SIGNS FROM OTHER DIRECTION.
- LINE OF SIGHT SHALL BE MAINTAINED BETWEEN FLAGPERSONS. REFER TO DRAWINGS 757-1 AND 757-2.

771-12F



TRANSPORTATION AND WORKS
HIGHWAY DESIGN DIVISION

LINE PAINTING PROCEDURES PAINTING CENTER CROSS HATCHING WITH MULTIPLE LANES ALL SPEED LIMITS WITH FLAGPERSONS

DRAWN BY: G. Clarke

DATE: Rev June 2018

NOT TO SCALE

TRAFFIC CONTROL MANUAL 2018

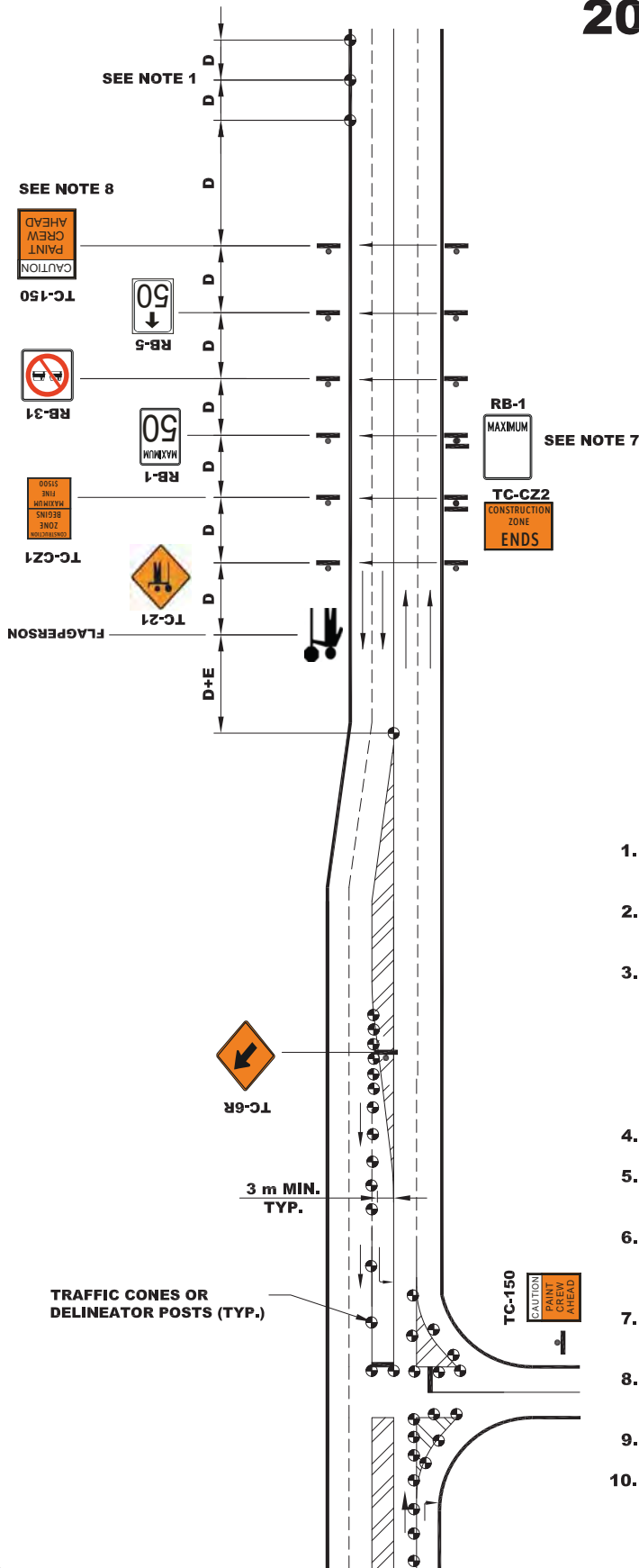

**WORK ZONE DIMENSIONS FOR
RIGHT SIDE OF INTERSECTION -
PAINTING TURNING ARROWS, STOP BARS
AND ISLANDS FOR 2 WAY TRAFFIC
ALL SPEEDS**

DIMENSION (m)	NORMAL POSTED REGULATORY SPEED					
	50	60	70	80	90	100
A	30	40	60	90	110	180
B	5/8	8/12	10/15	10/15	12/18	15/20
C	30	40	40	50	50	50
D	50	50	75	100	100	150
E	35	50	50	75	75	75

POSTED SPEED IS EXISTING SPEED LIMIT (km/h)

A - TAPER LANE WHEN NO LANE CONTROL PRESENT

B - MAX. DELINEATOR SPACING IN TAPER/WORK ZONE

C - TRAFFIC CONTROL PERSON SETBACK (m)

D - DISTANCE BETWEEN CONSTRUCTION SIGNS

E - BUFFER AREA LENGTH BETWEEN TAPER AND WORK ZONE

NOTES

- THREE CONES TO BE PLACED IN ADVANCE OF SIGNS, AS SHOWN, EITHER ON THE SHOULDER OR THE CENTERLINE.
- ALL PERSONNEL WORKING ON OR NEAR THE ROADWAY MUST WEAR REQUIRED PERSONAL PROTECTIVE EQUIPMENT.
- TRAFFIC CONES ARE TO BE USED TO DEFINE ALL INDIVIDUAL WORK ZONES OR WHERE WET PAINT EXISTS AND TO CHANNELIZE TRAFFIC AS REQUIRED WITH WELL TAPERED ENDS AS SHOWN IN EXAMPLE ABOVE. CONE PLACEMENT MUST BE AS PER THE CONSTRUCTION DISTANCE TABLE ABOVE AND ON PAGE 799-1, INCLUDING TAPERS. PLACE CONES ON ISLANDS AND STOP BARS AFTER PAINTING COMPLETED.
- TWO ORANGE FLAGS TO BE MOUNTED ON EACH SIGN STAND.
- THE FLAGPERSON AND FLAGPERSON SIGN (TC-21) TO BE PLACED WHEN AND WHERE REQUIRED.
- WHEN PAINTING LANES, TRAFFIC, MUST BE ALLOWED A THROUGH LANE AT ALL TIMES WITH A MINIMUM WIDTH OF 3 m, PAINTED AREAS MUST BE COMPLETELY CLOSED TO TRAFFIC.
- INSTALL AN RB-1 SPEED LIMIT SIGN TO DISPLAY THE NORMAL OPERATING SPEED LIMIT OF THE HIGHWAY.
- WHEN NORMAL POSTED SPEED IS GREATER THAN 80 km/h VARIABLE MESSAGE SIGN IS RECOMMENDED.
- DUPLICATE SIGNS FROM THE OTHER DIRECTION. (SEE 771-13F)
- LINE OF SIGHT SHALL BE MAINTAINED BETWEEN FLAGPERSONS. REFER TO DRAWINGS 757-1 AND 757-2.

771-13AF



TRANSPORTATION AND WORKS
HIGHWAY DESIGN DIVISION

LINE PAINTING PROCEDURES

PAINTING TURNING ARROWS, STOP BARS AND ISLANDS (RIGHT SIDE)
MULTIPLE LANES SITUATIONS, ALL SPEED LIMITS, WITH FLAGPERSONS

DRAWN BY: G. Clarke

DATE: Rev June 2018

NOT TO SCALE

TRAFFIC CONTROL MANUAL 2018

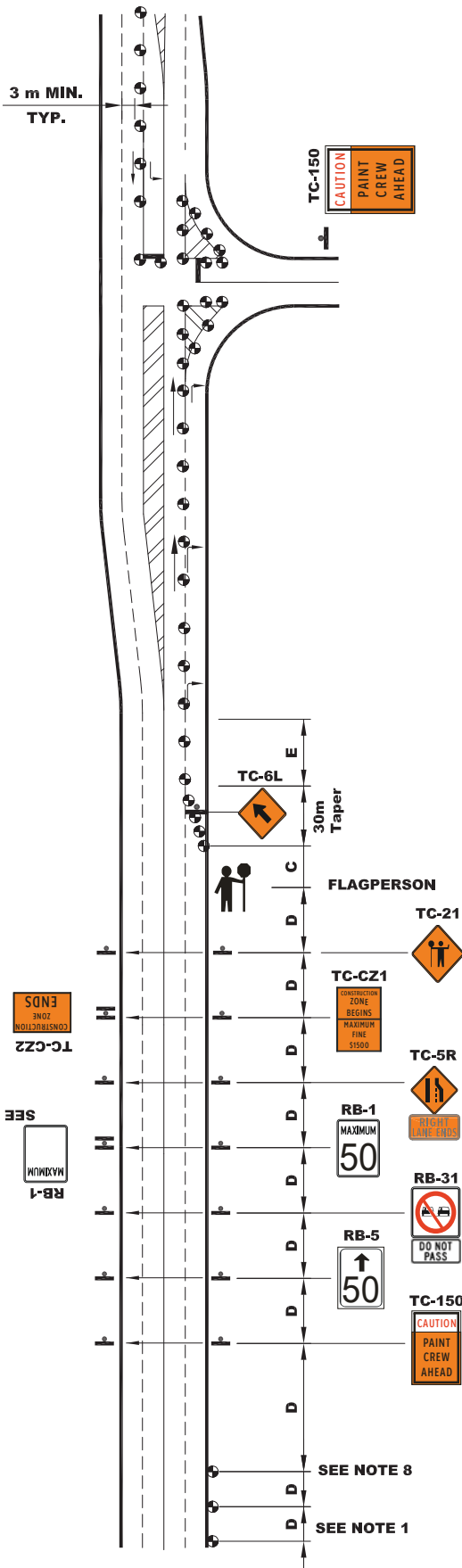

WORK ZONE DIMENSIONS FOR LEFT SIDE OF INTERSECTION - PAINTING TURNING ARROWS, STOP BARS AND ISLANDS, MULTIPLE LANES ALL SPEED LIMITS WITH FLAGPERSONS

DIMENSION (m)	NORMAL POSTED REGULATORY SPEED					
	50	60	70	80	90	100
A	30	40	60	90	110	180
B	5/8	8/12	10/15	10/15	12/18	15/20
C	30	40	40	50	50	50
D	50	50	75	100	100	150
E	35	50	50	75	75	75

POSTED SPEED IS EXISTING SPEED LIMIT (km/h)

A - TAPER LANE WHEN NO LANE CONTROL PRESENT

B - MAX. DELINEATOR SPACING IN TAPER/WORK ZONE

C - TRAFFIC CONTROL PERSON SETBACK (m)

D - DISTANCE BETWEEN CONSTRUCTION SIGNS

E - BUFFER AREA LENGTH BETWEEN TAPER AND WORK ZONE

NOTES

- THREE CONES TO BE PLACED IN ADVANCE OF SIGNS AS SHOWN, ALONG THE SHOULDER OR THE CENTERLINE.
- ALL PERSONNEL WORKING ON OR NEAR THE ROADWAY MUST WEAR REQUIRED PERSONAL EQUIPMENT.
- TRAFFIC CONES ARE TO BE USED TO DEFINE ALL INDIVIDUAL WORK ZONES OR WHERE WET PAINT EXISTS AND TO CHANNELIZE TRAFFIC AS REQUIRED WITH WELL TAPERED ENDS AS SHOWN IN EXAMPLE ABOVE. CONE PLACEMENT MUST BE AS PER THE CONSTRUCTION DISTANCE TABLE ABOVE AND ON PAGE 799-1, INCLUDING TAPERS. PLACE CONES ON ISLANDS AND STOP BARS AFTER PAINTING COMPLETED.
- TWO ORANGE FLAGS TO BE MOUNTED ON EACH SIGN STAND.
- THE FLAGPERSON AND FLAGPERSON SIGN (TC-21) TO BE PLACED WHEN AND WHERE REQUIRED.
- WHEN PAINTING LANES, TRAFFIC, MUST BE ALLOWED A THROUGH LANE AT ALL TIMES WITH A MINIMUM WIDTH OF 3 m, PAINTED AREAS MUST BE COMPLETELY CLOSED TO TRAFFIC.
- TEMPORARILY INSTALL AN RB-1 SPEED LIMIT SIGN TO DISPLAY THE NORMAL OPERATING SPEED LIMIT OF THE HIGHWAY.
- WHEN NORMAL POSTED SPEED LIMIT IS GREATER THAN 80 km/h VARIABLE MESSAGE SIGN IS RECOMMENDED.
- DUPLICATE SIGNS FROM OTHER DIRECTION. (SEE 771-13AF)
- LINE OF SIGHT SHALL BE MAINTAINED BETWEEN FLAGPERSONS. REFER TO DRAWINGS 757-1 AND 757-2.

771-13F



TRANSPORTATION AND WORKS
HIGHWAY DESIGN DIVISION

LINE PAINTING PROCEDURES

PAINTING TURNING ARROWS, STOP BARS AND ISLANDS (LEFT SIDE)
MULTIPLE LANE SITUATIONS, ALL SPEED LIMITS, WITH FLAGPERSONS

DRAWN BY: G. Clarke

DATE: Rev June 2018

NOT TO SCALE

TRAFFIC CONTROL MANUAL

2018

WORK ZONE DIMENSIONS FOR PAINTING INTERSECTION ROADWAY, ALL SPEED LIMITS WITH FLAGPERSONS

DIMENSION (m)	NORMAL POSTED REGULATORY SPEED					
	50	60	70	80	90	100
A	30	40	60	90	110	180
B	5/8	8/12	10/15	10/15	12/18	15/20
C	30	40	40	50	50	50
D	50	50	75	100	100	150
E	35	50	50	75	75	75

POSTED SPEED IS EXISTING SPEED LIMIT (km/h)

A - TAPER LANE WHEN NO LANE CONTROL PRESENT

B - MAX. DELINEATOR SPACING IN TAPER/WORK ZONE

C - TRAFFIC CONTROL PERSON SETBACK (m)

D - DISTANCE BETWEEN CONSTRUCTION SIGNS

E - BUFFER AREA LENGTH BETWEEN TAPER AND WORK ZONE

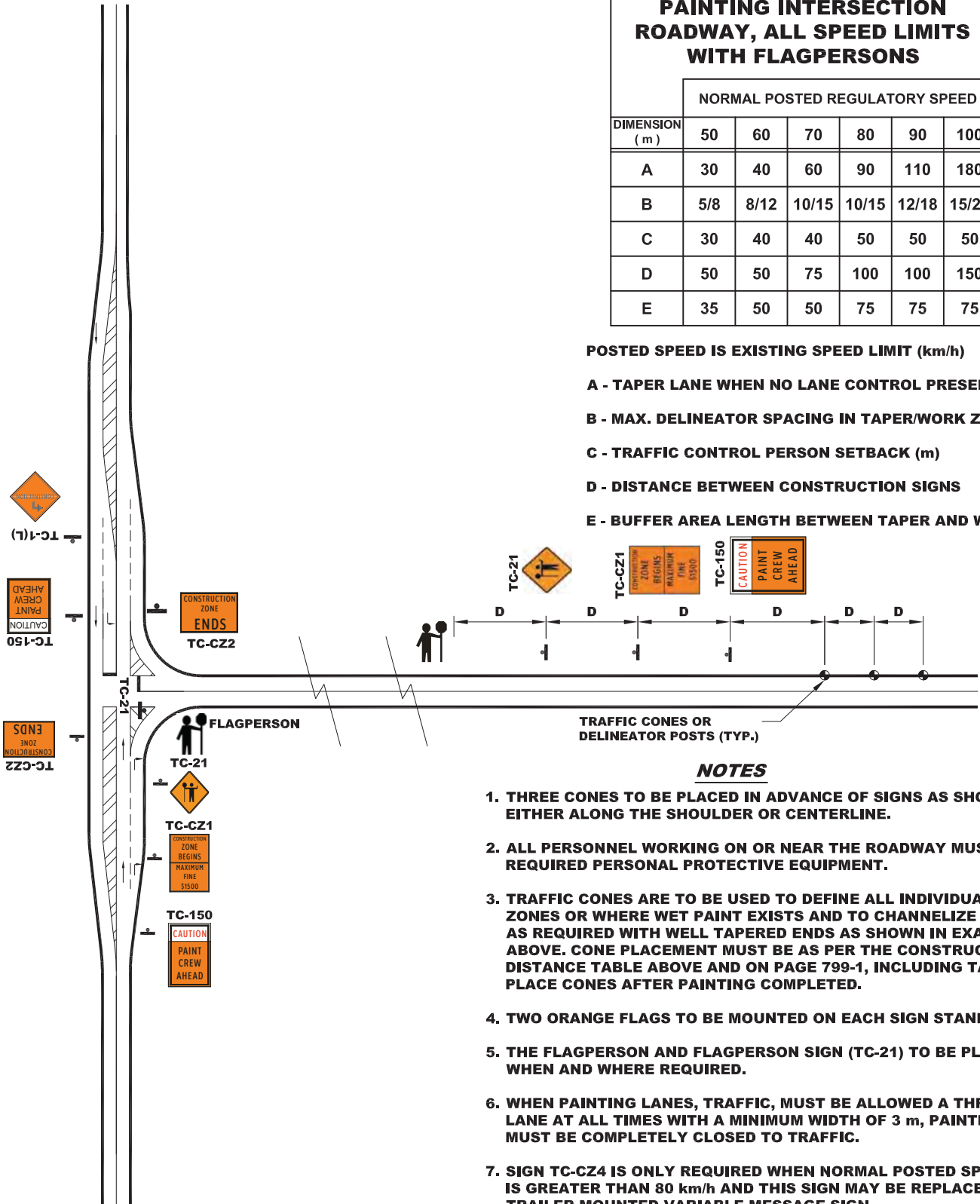

NOTES

- THREE CONES TO BE PLACED IN ADVANCE OF SIGNS AS SHOWN, EITHER ALONG THE SHOULDER OR CENTERLINE.
- ALL PERSONNEL WORKING ON OR NEAR THE ROADWAY MUST WEAR REQUIRED PERSONAL PROTECTIVE EQUIPMENT.
- TRAFFIC CONES ARE TO BE USED TO DEFINE ALL INDIVIDUAL WORK ZONES OR WHERE WET PAINT EXISTS AND TO CHANNELIZE TRAFFIC AS REQUIRED WITH WELL TAPERED ENDS AS SHOWN IN EXAMPLE ABOVE. CONE PLACEMENT MUST BE AS PER THE CONSTRUCTION DISTANCE TABLE ABOVE AND ON PAGE 799-1, INCLUDING TAPERS. PLACE CONES AFTER PAINTING COMPLETED.
- TWO ORANGE FLAGS TO BE MOUNTED ON EACH SIGN STAND.
- THE FLAGPERSON AND FLAGPERSON SIGN (TC-21) TO BE PLACED WHEN AND WHERE REQUIRED.
- WHEN PAINTING LANES, TRAFFIC, MUST BE ALLOWED A THROUGH LANE AT ALL TIMES WITH A MINIMUM WIDTH OF 3 m, PAINTED AREAS MUST BE COMPLETELY CLOSED TO TRAFFIC.
- SIGN TC-CZ4 IS ONLY REQUIRED WHEN NORMAL POSTED SPEED LIMIT IS GREATER THAN 80 km/h AND THIS SIGN MAY BE REPLACED WITH A TRAILER MOUNTED VARIABLE MESSAGE SIGN.

771-14F



TRANSPORTATION AND WORKS
HIGHWAY DESIGN DIVISION

LINE PAINTING PROCEDURES PAINTING INTERSECTING ROADWAY ALL SPEED LIMITS WITH FLAGPERSONS

DRAWN BY: G. Clarke

DATE: Rev June 2018

NOT TO SCALE

TRAFFIC CONTROL MANUAL

2018

WORK ZONE DIMENSIONS FOR LINE MARKINGS - RAPID MOVING

DIMENSION (m)	NORMAL POSTED REGULATORY SPEED					
	50	60	70	80	90	100
A	30	40	60	90	110	180
B	5/8	8/12	10/15	10/15	12/18	15/20
C	30	40	40	50	50	50
D	50	50	75	100	100	150
E	35	50	50	75	75	75

POSTED SPEED IS EXISTING SPEED LIMIT (km/h)

- A - TAPER LANE WHEN NO LANE CONTROL PRESENT
- B - MAX. DELINEATOR SPACING IN TAPER/WORK ZONE
- C - TRAFFIC CONTROL PERSON SETBACK (m)
- D - DISTANCE BETWEEN CONSTRUCTION SIGNS
- E - BUFFER AREA LENGTH BETWEEN TAPER AND WORK ZONE

NOTES

1. ALL PERSONNEL WORKING ON OR NEAR THE ROADWAY MUST WEAR REQUIRED PERSONAL PROTECTIVE EQUIPMENT.

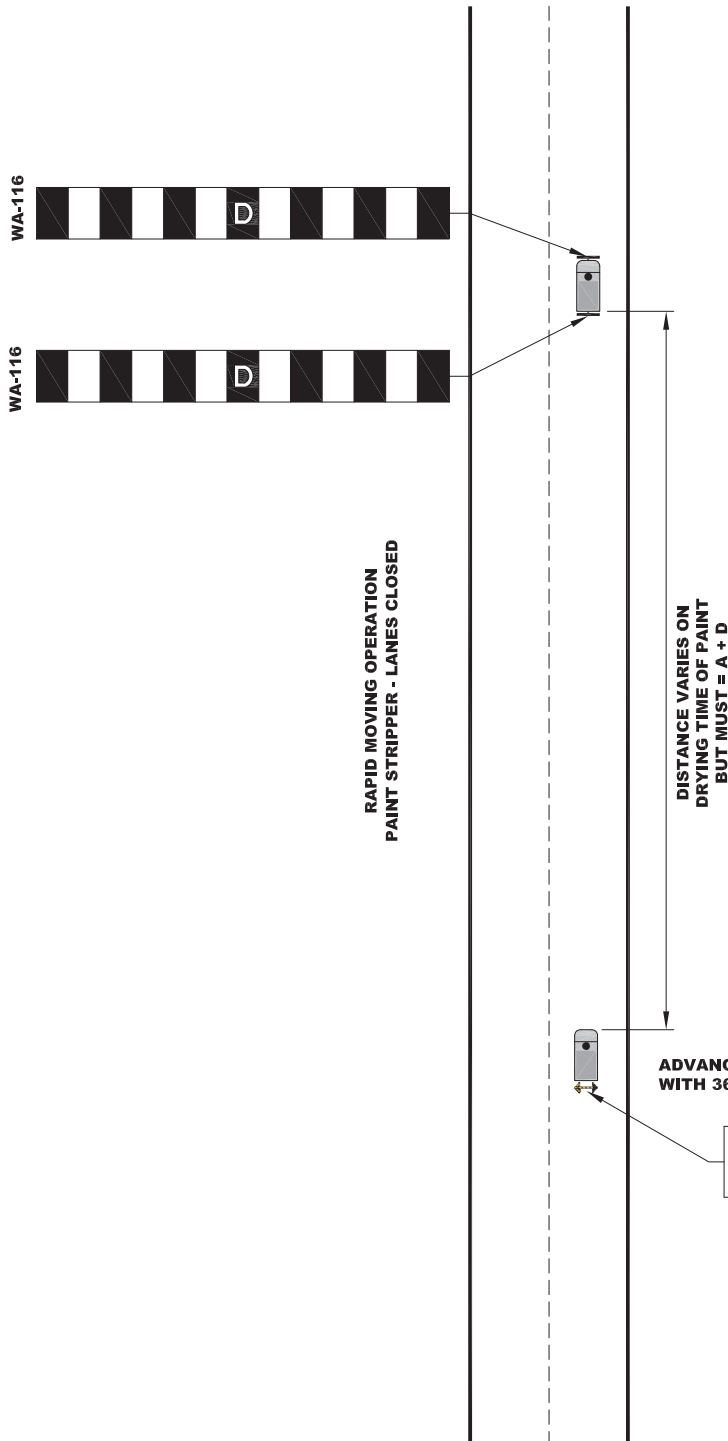

771-15



TRANSPORTATION AND WORKS
HIGHWAY DESIGN DIVISION

LINE PAINTING PROCEDURES LINE MARKINGS - RAPID MOVING

DRAWN BY: G. Squire

DATE: Rev June 2018

NOT TO SCALE

TRAFFIC CONTROL MANUAL 2018

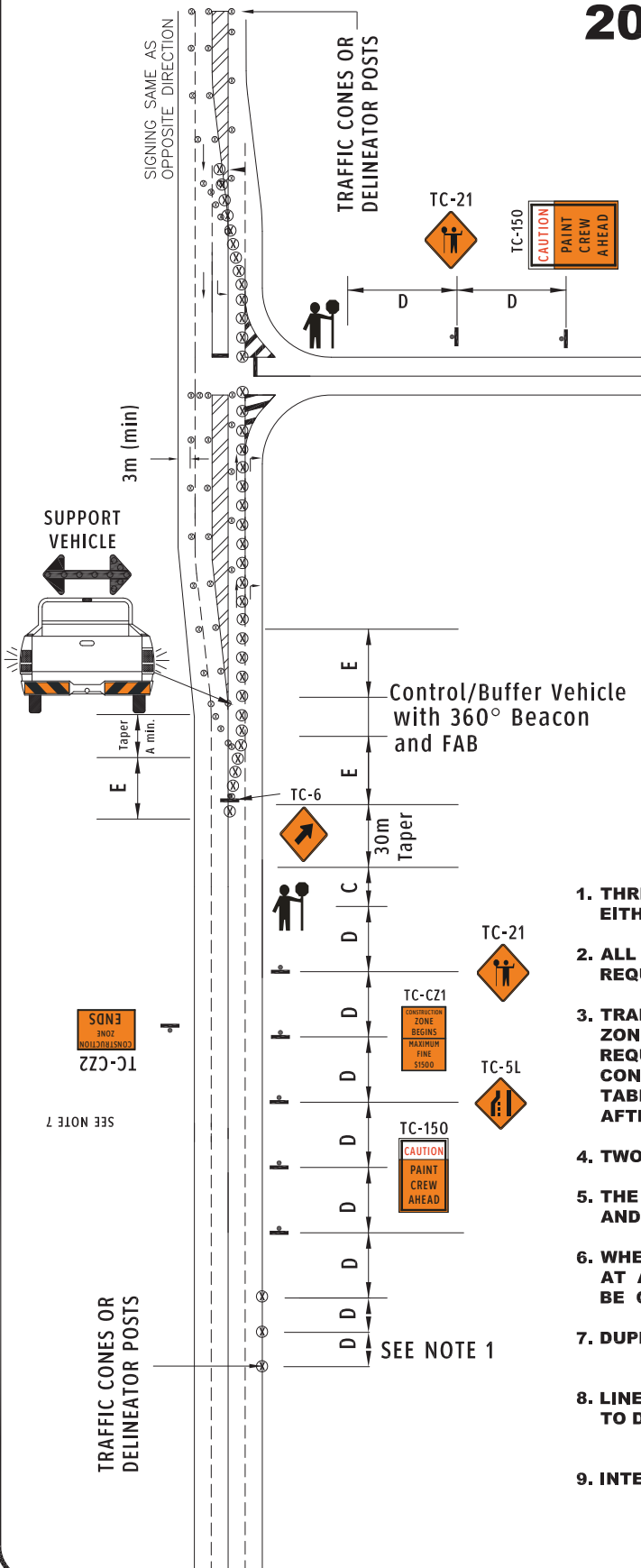

WORK ZONE DIMENSIONS FOR PAINTING TURNING ARROWS, STOP BARS AND CROSSWALKS MULTIPLE LANES LOW SPEED LIMITS WITH FLAGPERSONS

DIMENSION (m)	NORMAL POSTED REGULATORY SPEED				
	50	60			
A	30	40			
B	5/8	8/12			
C	30	40			
D	50	50			
E	35	50			

POSTED SPEED IS EXISTING SPEED LIMIT (km/h)

A - TAPER LANE WHEN NO LANE CONTROL PRESENT

B - MAX. DELINEATOR SPACING IN TAPER/WORK ZONE

C - TRAFFIC CONTROL PERSON SETBACK (m)

D - DISTANCE BETWEEN CONSTRUCTION SIGNS

E - BUFFER AREA LENGTH BETWEEN TAPER AND WORK ZONE

NOTES

- THREE CONES TO BE PLACED IN ADVANCE OF SIGNS, AS SHOWN, EITHER ON THE SHOULDER OR ON THE CENTERLINE.
- ALL PERSONNEL WORKING ON OR NEAR THE ROADWAY MUST WEAR REQUIRED PERSONAL PROTECTIVE EQUIPMENT.
- TRAFFIC CONES ARE TO BE USED TO DEFINE ALL INDIVIDUAL WORK ZONES OR WHERE WET PAINT EXISTS AND TO CHANNELIZE TRAFFIC AS REQUIRED WITH WELL TAPERED ENDS AS SHOWN IN EXAMPLE ABOVE. CONE PLACEMENT MUST BE AS PER THE CONSTRUCTION DISTANCE TABLE ABOVE AND ON PAGE 799-2, INCLUDING TAPERS. PLACE CONES AFTER PAINTING COMPLETED.
- TWO ORANGE FLAGS TO BE MOUNTED ON EACH SIGN STAND.
- THE FLAGPERSON AND FLAGPERSON SIGN (TC-21) TO BE PLACED WHEN AND WHERE REQUIRED.
- WHEN PAINTING LANES, TRAFFIC, MUST BE ALLOWED A THROUGH LANE AT ALL TIMES WITH A MINIMUM WIDTH OF 3m. PAINTED AREAS MUST BE COMPLETELY CLOSED TO TRAFFIC.
- DUPLICATE SIGNS FROM OTHER DIRECTION.
- LINE OF SIGHT SHALL BE MAINTAINED BETWEEN FLAGPERSONS. REFER TO DRAWINGS 757-1 AND 757-2.
- INTERSECTING ROADS TO BE SIGNED IN ACCORDANCE WITH 756-2.

771-17F



TRANSPORTATION AND WORKS
HIGHWAY DESIGN DIVISION

LINE PAINTING PROCEDURES

PAINTING TURNING ARROWS, STOP BARS, CROSSWALKS
MULTIPLE LANES

LOW SPEED LIMITS WITH FLAGPERSONS

DRAWN BY: G. Clarke

DATE: Rev November 2018

NOT TO SCALE

TRAFFIC CONTROL MANUAL 2018

NOTE:

1. THIS ACTIVITY APPLIES TO MAINTENANCE OPERATIONS ONLY.
2. TWO-WAY TRAFFIC SITUATIONS REQUIRE DUPLICATE SIGNAGE ON EACH APPROACH.
3. A DELINEATOR TO BE ADDED TO THE END OF THE WINDROW.
4. SPEED LIMIT SIGNS AND SPEED REDUCED AHEAD SIGNS REQUIRED WHEN REDUCING SPEED.
5. POST NORMAL SPEED AFTER WORK ZONE IF PERMANENTLY INSTALLED SPEED LIMIT SIGN DOES NOT OCCUR WITHIN 300 M OF THE END OF THE REDUCED SPEED ZONE.

GRADING OPERATIONS

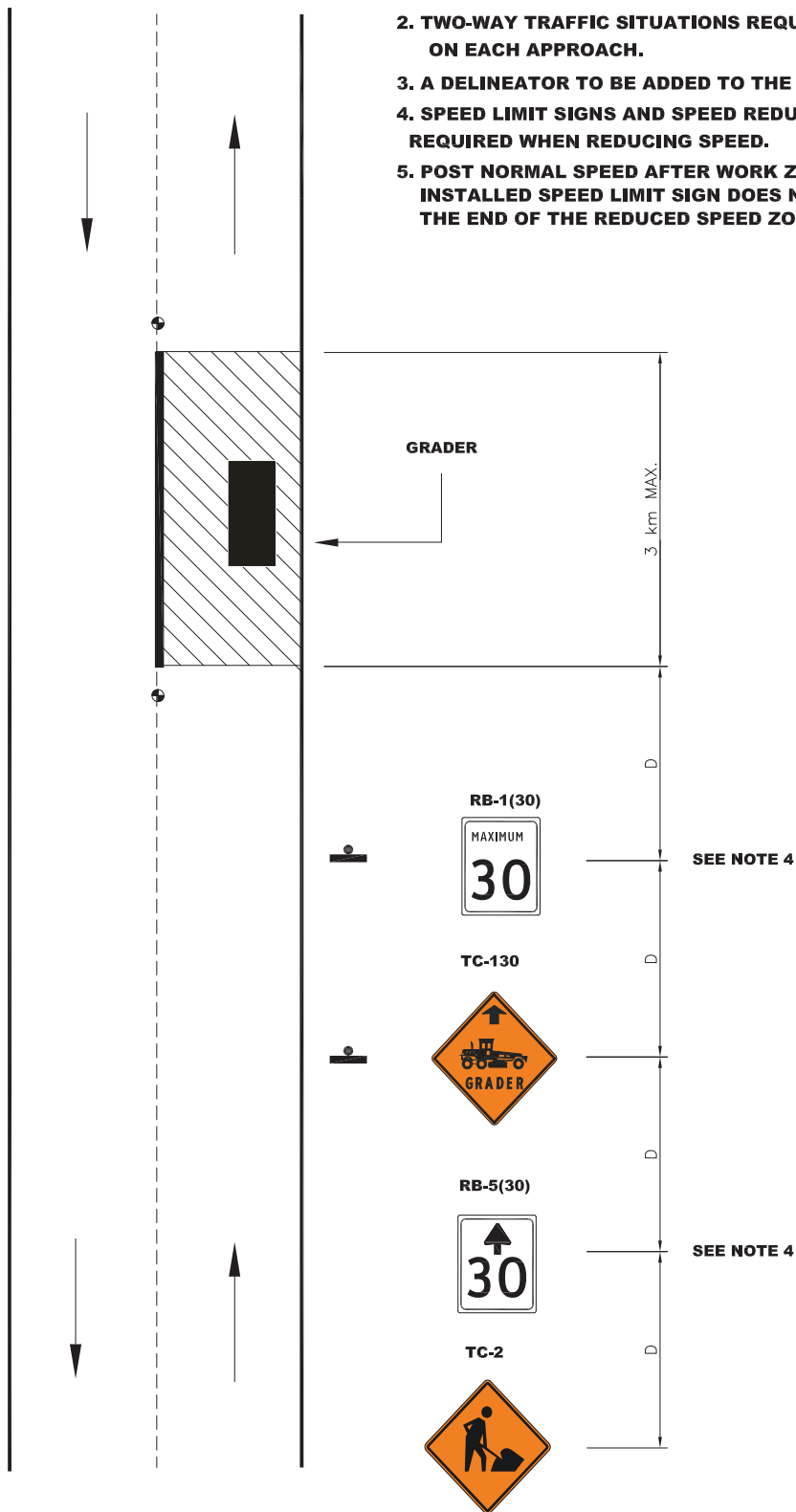

775-1



TRANSPORTATION AND WORKS
HIGHWAY DESIGN DIVISION

GRADING OPERATIONS

DRAWN BY: G. Clarke

DATE: Rev June 2018

NOT TO SCALE

TRAFFIC CONTROL MANUAL

2018

WORK ZONE DIMENSIONS FOR ROAD CLOSED TWO LANE ROAD ALL DURATIONS

DIMENSION (m)	NORMAL POSTED REGULATORY SPEED					
	50	60	70	80	90	100
A	30	40	60	90	110	180
B	5/8	8/12	10/15	10/15	12/18	15/20
C	30	40	40	50	50	50
D	50	50	75	100	100	150
E	35	50	50	75	75	75

POSTED SPEED IS EXISTING SPEED LIMIT (km/h)

A - TAPER LANE WHEN NO LANE CONTROL PRESENT

B - MAX. DELINEATOR SPACING IN TAPER/WORK ZONE

C - TRAFFIC CONTROL PERSON SETBACK (m)

D - DISTANCE BETWEEN CONSTRUCTION SIGNS

E - BUFFER AREA LENGTH BETWEEN TAPER AND WORK ZONE

NOTES

1. IF A CRITICAL HAZARD EXISTS DOWNSTREAM OF THE PROPOSED ROAD CLOSURE, ENSURE VEHICLES CAN NOT DRIVE AROUND ENDS OF BARRICADE. USE DRUMS OR JERSEY BARRIERS IF REQUIRED. ALL JERSEY BARRIERS ARE REQUIRED TO HAVE TC-64B BARRICADE SIGNS ATTACHED ON FRONT.
2. DUPLICATE SIGNAGE IN OTHER DIRECTION.
3. ANY INTERSECTIONS IN CLOSE PROXIMITY TO THE ROAD CLOSURE SHOULD INDICATE THE ROAD CLOSURE AHEAD. PROVIDE DETOUR INFORMATION AND DISTANCE WHERE APPLICABLE.

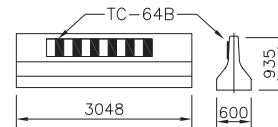

Jersey Barrier
SEE NOTE 1

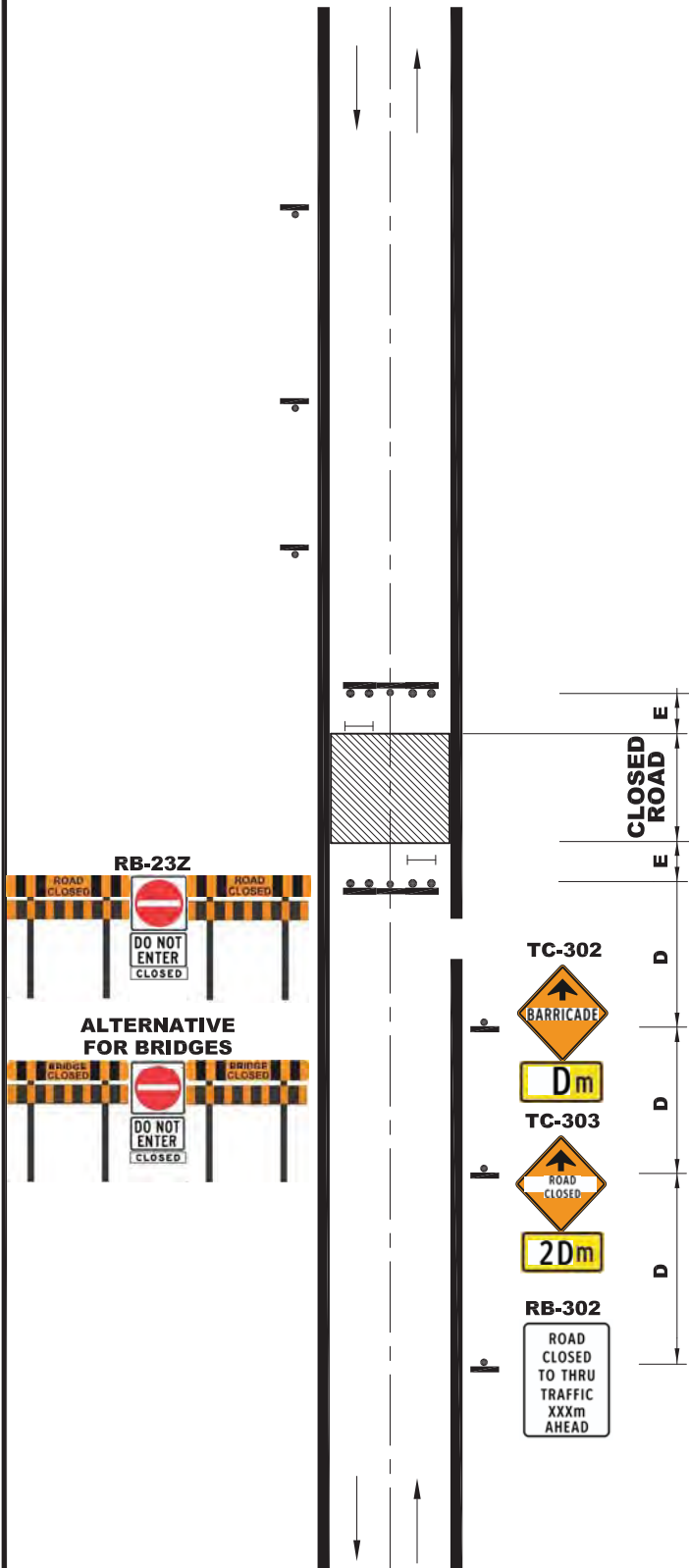

776-1

TRAFFIC CONTROL MANUAL 2018

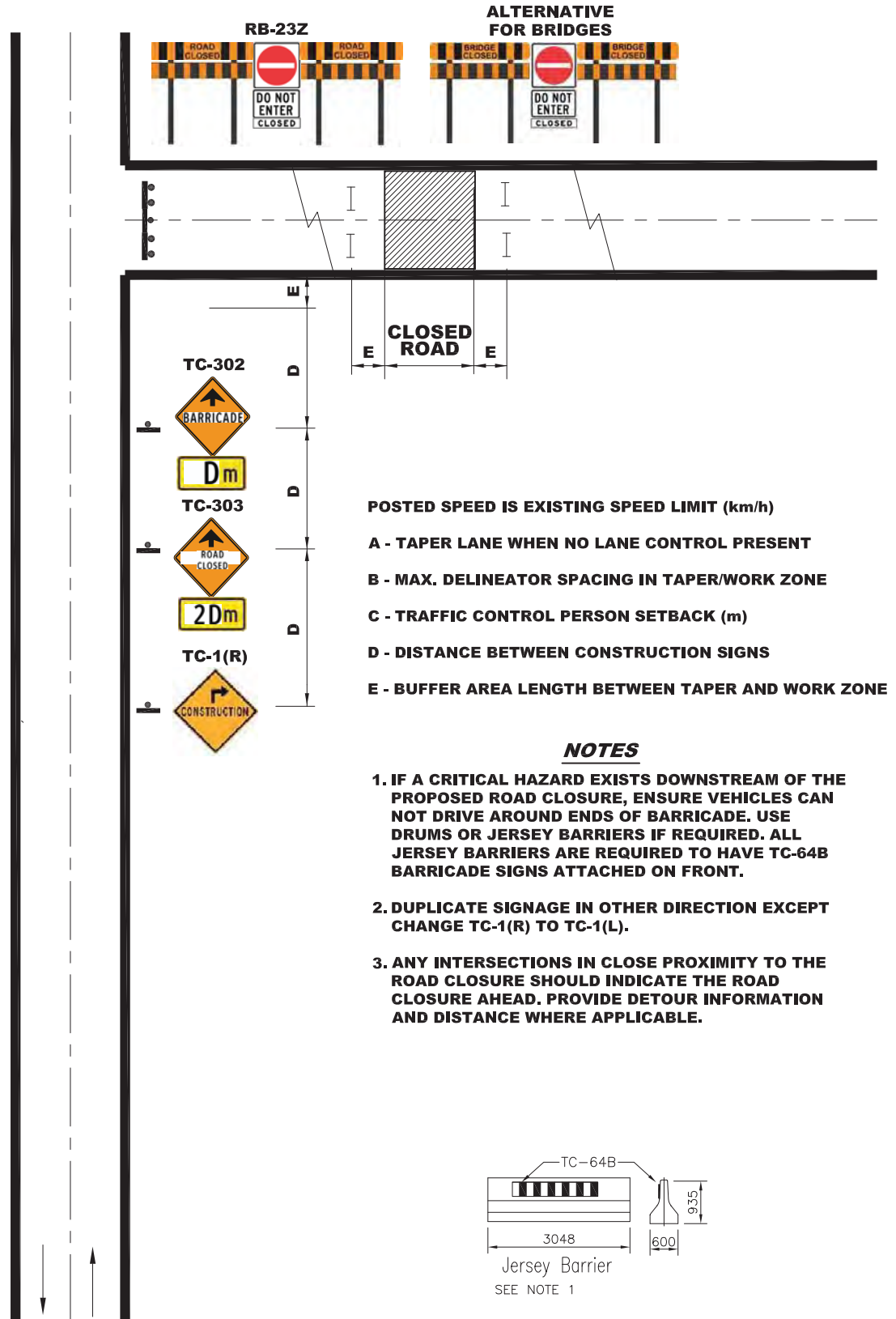

776-2

TRAFFIC CONTROL MANUAL 2018

DUPLICATE SIGNS FROM OTHER DIRECTION

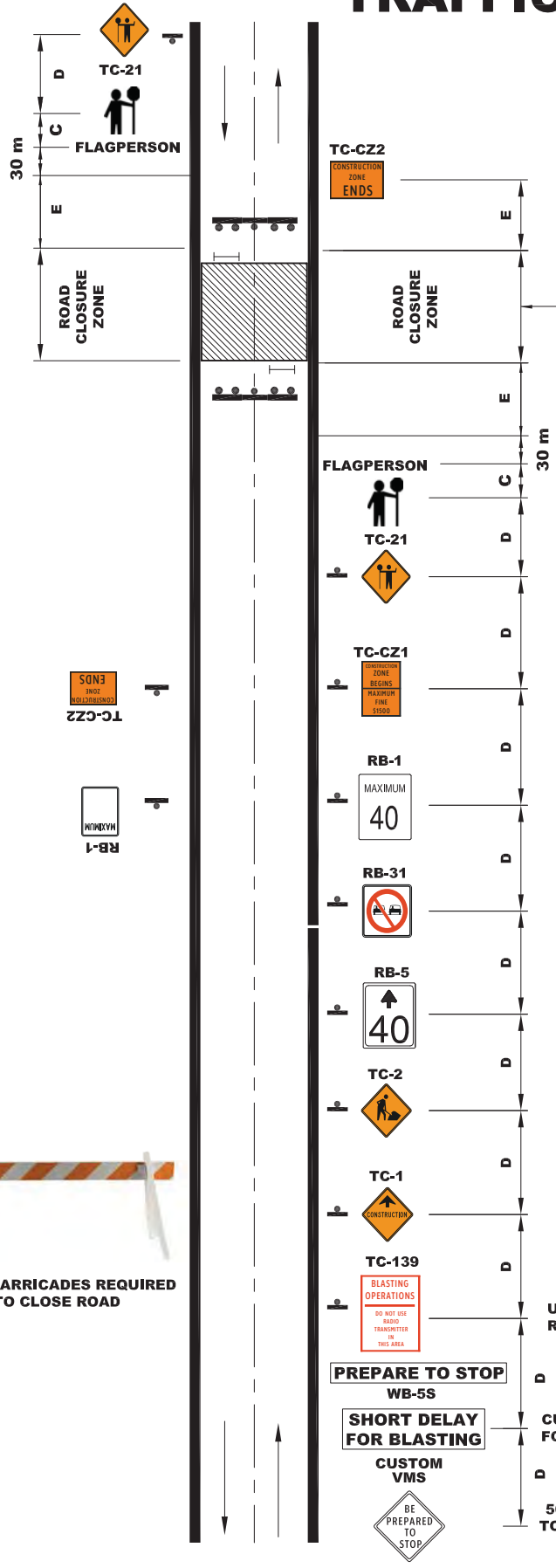

WORK ZONE DIMENSIONS FOR ROAD CLOSED TWO LANE ROAD ALL DURATIONS

DIMENSION (m)	NORMAL POSTED REGULATORY SPEED					
	50	60	70	80	90	100
A	30	40	60	90	110	180
B	5/8	8/12	10/15	10/15	12/18	15/20
C	30	40	40	50	50	50
D	50	50	75	100	100	150
E	35	50	50	75	75	75

THE MAXIMUM
CLOSURE ZONE LENGTH
SHALL BE 3.0 km

- POSTED SPEED IS EXISTING SPEED LIMIT (km/h)
- A - TAPER LANE WHEN NO LANE CONTROL PRESENT
- B - MAX. DELINEATOR SPACING IN TAPER/WORK ZONE
- C - TRAFFIC CONTROL PERSON SETBACK (m)
- D - DISTANCE BETWEEN CONSTRUCTION SIGNS
- E - BUFFER AREA LENGTH BETWEEN TAPER AND WORK ZONE

NOTES

1. IF A CRITICAL HAZARD EXISTS DOWNSTREAM OF THE PROPOSED ROAD CLOSURE, ENSURE VEHICLES CAN NOT DRIVE AROUND ENDS OF BARRICADE. USE DRUMS OR OTHER BARRIERS IF REQUIRED. ALL BARRIERS ARE REQUIRED TO HAVE TC-64B BARRICADE SIGNS ATTACHED ON FRONT.
2. DUPLICATE SIGNAGE IN OTHER DIRECTION.
3. ANY INTERSECTIONS IN CLOSE PROXIMITY TO THE ROAD CLOSURE SHOULD INDICATE THE ROAD CLOSURE AHEAD. PROVIDE DETOUR INFORMATION AND DISTANCE WHERE APPLICABLE.

USE TC-139 FOR BLASTING ROAD CLOSURES ONLY

CUSTOMIZE MESSAGE ON VMS FOR ROAD CLOSURE CONDITION

500M TC-112

776-3

TRAFFIC CONTROL MANUAL 2018

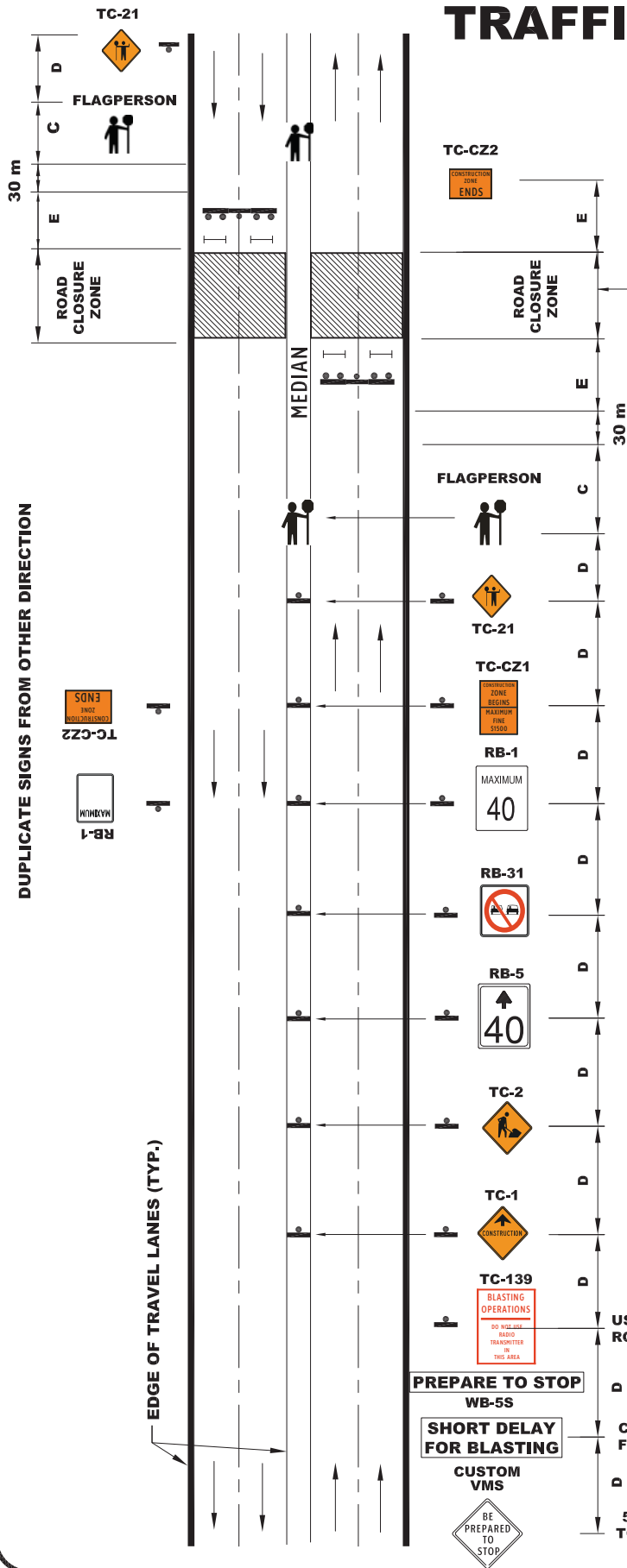

WORK ZONE DIMENSIONS FOR ONE LANE CLOSED WITH FLAGPERSONS DIVIDED HIGHWAY VERY SHORT & SHORT DURATION

DIMENSION (m)	NORMAL POSTED REGULATORY SPEED					
	50	60	70	80	90	100
A	30	40	60	90	110	180
B	5/8	5/12	5/15	5/15	5/18	5/20
C	30	40	40	50	50	50
D	50	50	75	100	100	150
E	35	50	50	75	75	75

- POSTED SPEED IS EXISTING SPEED LIMIT (km/h)**
- A - TAPER LANE WHEN NO LANE CONTROL PRESENT**
 - B - MAX. DELINEATOR SPACING IN TAPER/WORK ZONE**
 - C - TRAFFIC CONTROL PERSON SETBACK (m)**
 - D - DISTANCE BETWEEN CONSTRUCTION SIGNS**
 - E - BUFFER AREA LENGTH BETWEEN TAPER AND WORK ZONE**

NOTES

1. IF A CRITICAL HAZARD EXISTS DOWNSTREAM OF THE PROPOSED ROAD CLOSURE, ENSURE VEHICLES CAN NOT DRIVE AROUND ENDS OF BARRICADE. USE DRUMS OR OTHER BARRIERS IF REQUIRED. ALL BARRIERS ARE REQUIRED TO HAVE TC-64B BARRICADE SIGNS ATTACHED ON FRONT.
2. DUPLICATE SIGNAGE IN OTHER DIRECTION.
3. ANY INTERSECTIONS IN CLOSE PROXIMITY TO THE ROAD CLOSURE SHOULD INDICATE THE ROAD CLOSURE AHEAD. PROVIDE DETOUR INFORMATION AND DISTANCE WHERE APPLICABLE.



LIGHT BARRICADES REQUIRED TO CLOSE ROAD

776-4

TRAFFIC CONTROL MANUAL 2018

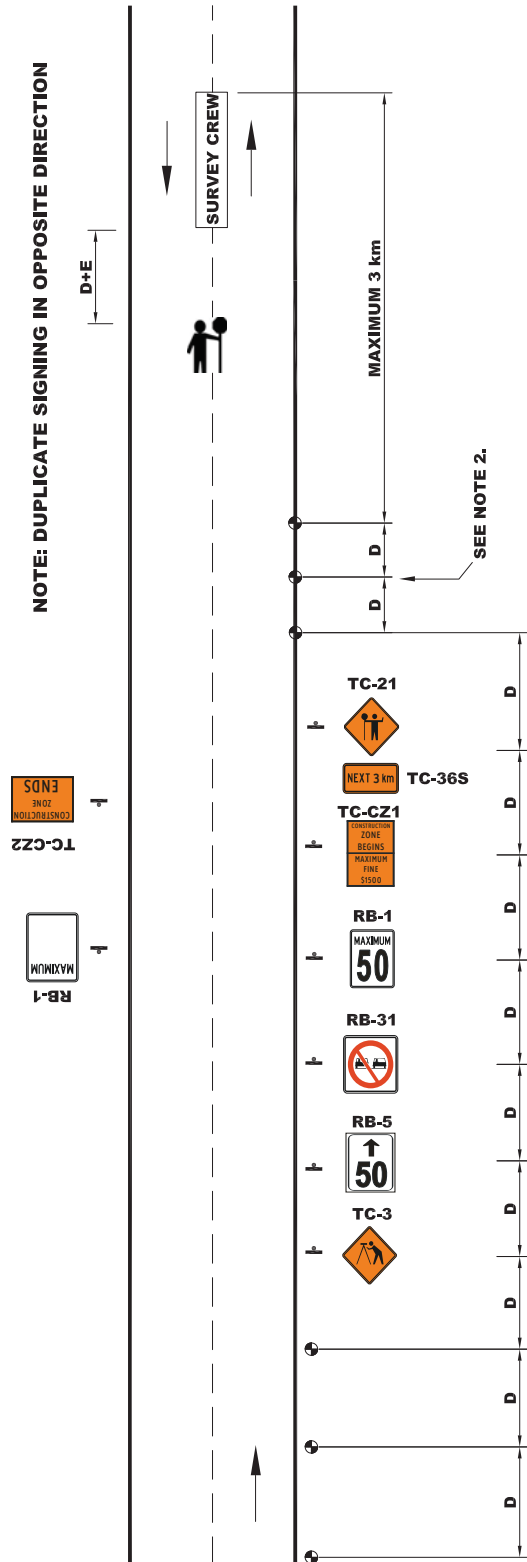

WORK ZONE DIMENSIONS FOR SURVEY SIGNAGE 2 WAY TRAFFIC						
DIMENSION (m)	NORMAL POSTED REGULATORY SPEED					
	50	60	70	80	90	100
A	30	40	60	90	110	180
B	5/8	8/12	10/15	10/15	12/18	15/20
C	30	40	40	50	50	50
D	50	50	75	100	100	150
E	35	50	50	75	75	75

POSTED SPEED IS EXISTING SPEED LIMIT (km/h)

- A - TAPER LANE WHEN NO LANE CONTROL PRESENT
- B - MAX. DELINEATOR SPACING IN TAPER/WORK ZONE
- C - TRAFFIC CONTROL PERSON SETBACK (m)
- D - DISTANCE BETWEEN CONSTRUCTION SIGNS
- E - BUFFER AREA LENGTH BETWEEN TAPER AND WORK ZONE

NOTES

1. A SEQUENCE OF THREE CONES TO BE PLACED IN ADVANCE OF THE SIGNS AS SHOWN. SPACING OF CONES TO BE THE SAME AS FOR SIGNS.
2. REPEAT THE SERIES OF CONES FROM NOTE 1, ALONG THE SHOULDER OR CENTERLINE, EVERY 500m, FOLLOWING THE TC-21 SIGN.
3. FLAGPERSON SHALL BE USED GOING BEHIND CREW MEMBERS WHO ARE SURVEYING, TO WARN WORKERS OF HAZARDS FROM MOVING VEHICLES.
4. TOTAL WORKING DISTANCE SHALL NOT EXCEED 3 km.
5. FLAGPERSON SHOULD BE EQUIPPED WITH A CUSTOMIZED PADDLE HAVING SLOW MARKINGS ON EACH SIDE.
6. THE SIGNS SHOULD BE INSTALLED SUCH THAT THE AREA WHERE SURVEYING BEGINS, IS A DISTANCE D + E FROM THE FLAGPERSON SIGN, AND DOES NOT EXCEED 3 km.

780-1



TRANSPORTATION AND WORKS
HIGHWAY DESIGN DIVISION

SURVEY CREW SIGNING 2 WAY TRAFFIC

DRAWN BY: G. Clarke

DATE: Rev November 2018

NOT TO SCALE

TRAFFIC CONTROL MANUAL 2018

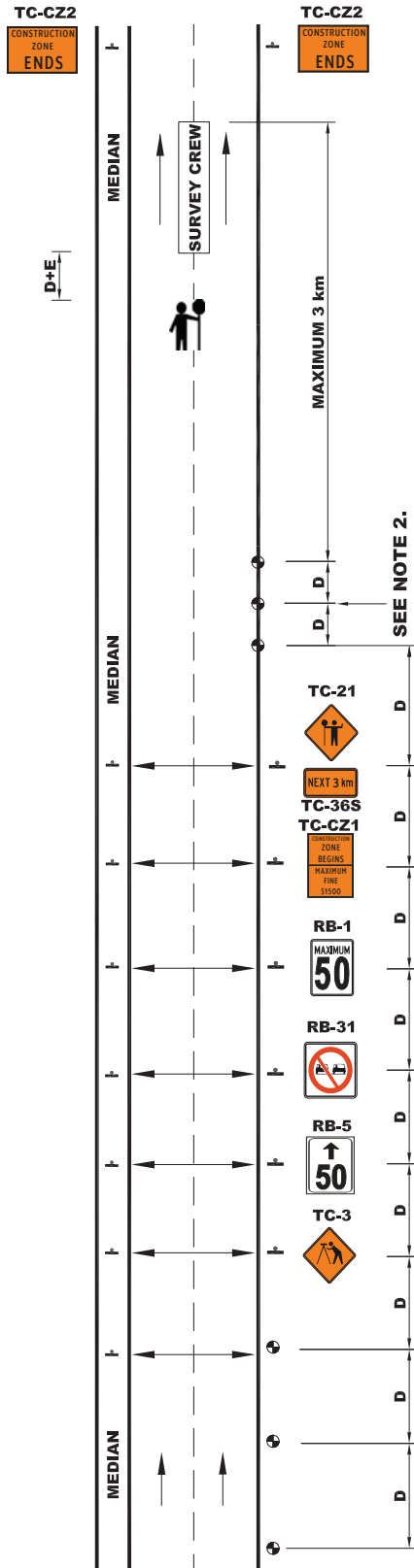

WORK ZONE DIMENSIONS FOR SURVEY SIGNAGE ON DIVIDED HIGHWAY						
DIMENSION (m)	NORMAL POSTED REGULATORY SPEED					
	50	60	70	80	90	100
A	30	40	60	90	110	180
B	5/8	8/12	10/15	10/15	12/18	15/20
C	30	40	40	50	50	50
D	50	50	75	100	100	150
E	35	50	50	75	75	75

POSTED SPEED IS EXISTING SPEED LIMIT (km/h)

A - TAPER LANE WHEN NO LANE CONTROL PRESENT

B - MAX. DELINEATOR SPACING IN TAPER/WORK ZONE

C - TRAFFIC CONTROL PERSON SETBACK (m)

D - DISTANCE BETWEEN CONSTRUCTION SIGNS

E - BUFFER AREA LENGTH BETWEEN TAPER AND WORK ZONE

NOTES

1. A SEQUENCE OF THREE CONES TO BE PLACED IN ADVANCE OF THE SIGNS AS SHOWN. SPACING OF CONES TO BE THE SAME AS FOR SIGNS.
2. REPEAT THE SERIES OF CONES FROM NOTE 1, ALONG THE SHOULDER OR CENTERLINE, EVERY 500m, FOLLOWING THE TC-21 SIGN.
3. FLAGPERSON SHALL BE USED GOING BEHIND CREW MEMBERS WHO ARE SURVEYING, TO WARN WORKERS OF HAZARDS FROM MOVING VEHICLES.
4. TOTAL WORKING DISTANCE SHALL NOT EXCEED 3 km.
5. FLAGPERSON SHOULD BE EQUIPPED WITH A CUSTOMIZED PADDLE HAVING SLOW MARKINGS ON EACH SIDE.
6. THE SIGNS SHOULD BE INSTALLED SUCH THAT THE AREA WHERE SURVEYING BEGINS, IS A DISTANCE D + E, FROM THE FLAGPERSON SIGN, AND DOES NOT EXCEED 3 km.

NOTE:
IF NORMAL SPEED LIMIT IS < 70 km/h
RB-5(50) NOT REQUIRED

SEE NOTE 1

SEE NOTE 2.

780-2



TRANSPORTATION AND WORKS
HIGHWAY DESIGN DIVISION

SURVEY CREW SIGNING DIVIDED HIGHWAY

DRAWN BY: G. Clarke

DATE: Rev November 2018 NOT TO SCALE

TRAFFIC CONTROL MANUAL 2018

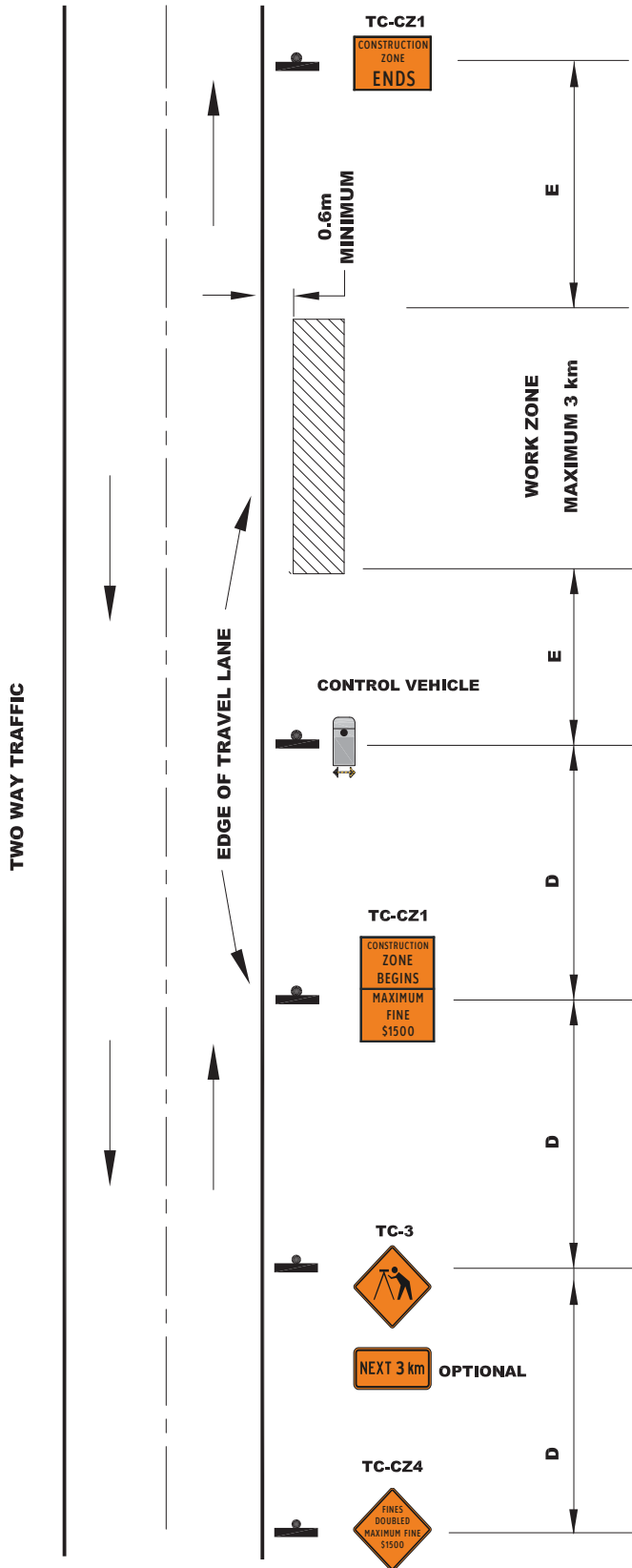

		NORMAL POSTED REGULATORY SPEED					
		50	60	70	80	90	100
DIMENSION (m)		30	40	60	90	110	180
A		30	40	60	90	110	180
B		5/8	8/12	10/15	10/15	12/18	15/20
C		30	40	40	50	50	50
D		50	50	75	100	100	150
E		35	50	50	75	75	75

POSTED SPEED IS EXISTING SPEED LIMIT (km/h)

A - TAPER LANE WHEN NO LANE CONTROL PRESENT

B - MAX. DELINEATOR SPACING IN TAPER/WORK ZONE

C - TRAFFIC CONTROL PERSON SETBACK (m)

D - DISTANCE BETWEEN CONSTRUCTION SIGNS

E - BUFFER AREA LENGTH BETWEEN TAPER AND WORK ZONE

NOTES

1. A SEQUENCE OF THREE CONES TO BE PLACED IN ADVANCE OF THE SIGNS AS SHOWN. SPACING OF CONES TO BE THE SAME AS FOR SIGNS.
2. REPEAT THE SERIES OF CONES FROM NOTE 1, ALONG THE SHOULDER OR CENTERLINE, EVERY 500m, FOLLOWING THE TC-21 SIGN.
3. FLAGPERSON SHALL BE USED GOING BEHIND CREW MEMBERS WHO ARE SURVEYING, TO WARN WORKERS OF HAZARDS FROM MOVING VEHICLES.
4. TOTAL WORKING DISTANCE SHALL NOT EXCEED 3 km.
5. FLAGPERSON SHOULD BE EQUIPPED WITH A CUSTOMIZED PADDLE HAVING SLOW MARKINGS ON EACH SIDE.
6. THE SIGNS SHOULD BE INSTALLED SUCH THAT THE AREA WHERE SURVEYING BEGINS, IS A DISTANCE D + E, FROM THE FLAGPERSON SIGN, AND DOES NOT EXCEED 3 km.

780-3



TRANSPORTATION AND WORKS
HIGHWAY DESIGN DIVISION

SURVEY CREW WORKING ADJACENT TO ROADWAY

DRAWN BY: G. Clarke

DATE: Rev November 2018 NOT TO SCALE

TRAFFIC CONTROL MANUAL 2018

MINIMUM HEIGHT
ACHIEVED WITH
FLAGS

MINIMUM HEIGHT
ACHIEVED
WITHOUT FLAGS

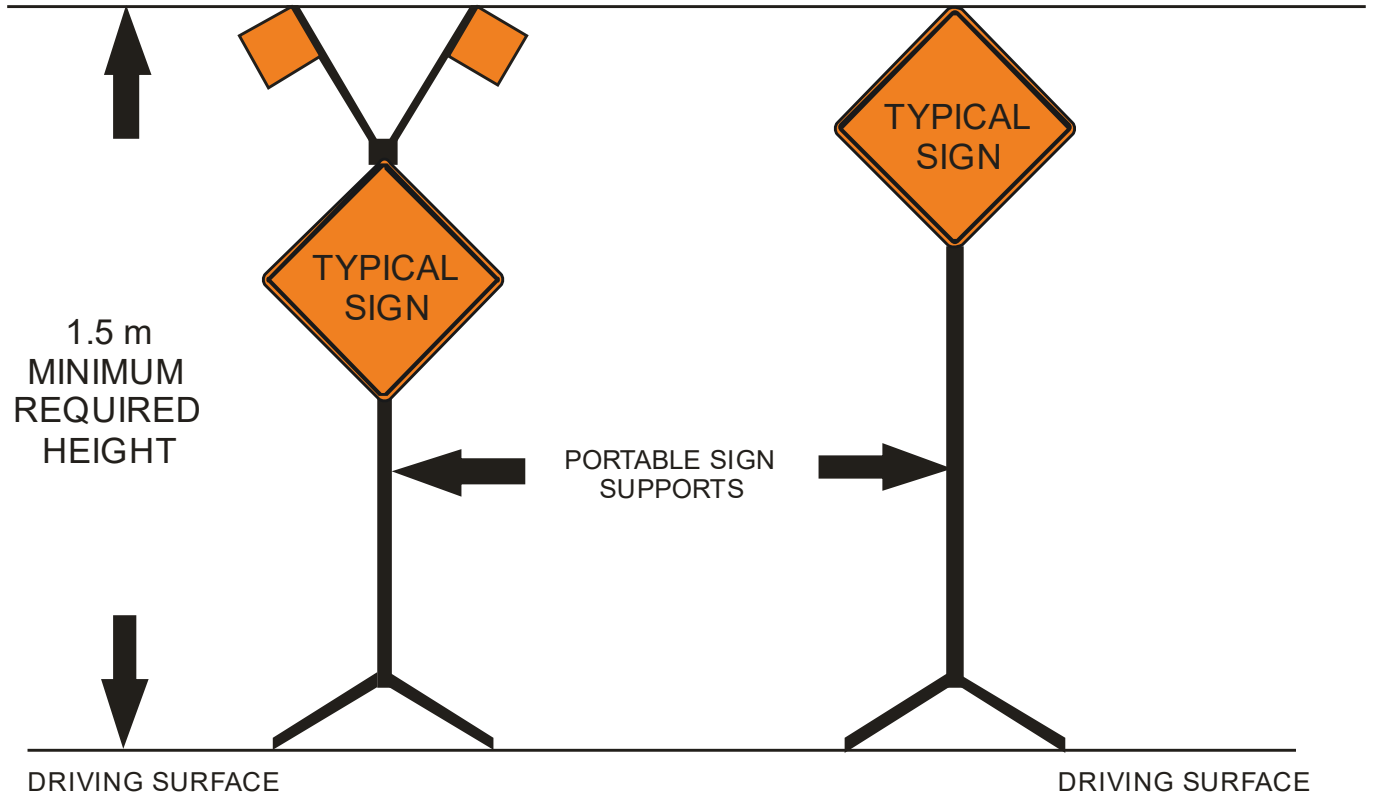

790-1



TRANSPORTATION AND WORKS
HIGHWAY DESIGN DIVISION

PORTABLE SIGN SUPPORTS

DRAWN BY: G. Clarke

DATE: Rev November 2018 NOT TO SCALE

TRAFFIC CONTROL MANUAL 2018

TIMING OF PORTABLE TRAFFIC LIGHTS

SERVICE VOLUME AT SIGNALIZED SINGLE LANE CONSTRUCTION SITES
VEHICLES PER HOUR - ONE WAY TRAFFIC

Length of Single lane (m) All Red Interval One Way (sec)	15	30	45	60	75	90	105	120	135	150	165	180	195	210	225	240	255	270	285	300	315	330	345	360
	150	810	785	760	725	700	675	650	625	605	570	545	520	495	470	450	415	390	370	345	325	300	275	245
140	800	775	750	710	685	660	635	610	580	545	520	490	470	445	420	380	360	335	310	285	260	235	200	175
130	795	765	735	695	670	640	610	585	560	520	490	465	440	410	385	345	320	290	270	240	215	195		
120	785	755	725	680	650	620	590	560	535	490	460	430	405	375	345	305	275	250	220					
110	775	740	710	660	630	595	565	530	500	460	425	395	360	330	300	255								
100	760	725	690	640	600	570	535	500	465	415	380	345	315	285										
90	754	710	670	615	575	540	500	460	420	365	330	295												
85	740	700	660	600	560	520	480	440	395	340	305													
80	730	690	645	585	545	500	455	410	370	315														
75	725	680	630	565	520	475	430	385	340															
70	715	670	620	545	500	450	405	360																
65	705	650	600	520	470	420	370																	
60	695	635	580	495	440																			
55	675	610	555	470																				
50	660	595	530																					
45	640	570																						
40	625																							

**Cycle
Length
(seconds)**

EXAMPLE

Given: Heaviest Approach Volume, One Way = 365 v/h
Length of Single Lane Section = 150m

Find: Length of Green Interval, One Direction
Length of All Red Interval

Solution: By applying the given figures to the table,
We find:

- a) Cycle Length = 90s
- b) All Red Interval = 22s
- c) Green Interval for Each Approach = $(\text{Cycle Length} - (2 \times \text{All Red}) - (2 \times \text{Amber})) / 2$
 $(90 - (2 \times 22) - (2 \times 3)) / 2 = 20\text{s}$

NOTES:

1. Operating Speed of 25km/h
2. Minimum Green 15 seconds
3. Amber is 3 seconds
4. Base on 50% Probability

791-1



TRAFFIC CONTROL MANUAL 2018

REFER TO DRAWING NUMBER 752-2 FOR SIGNAGE FROM OTHER DIRECTION
LINE OF SIGHT SHALL BE MAINTAINED BETWEEN AUTOMATED FLAGGER
ASSISTANCE DEVICE AND OPERATOR

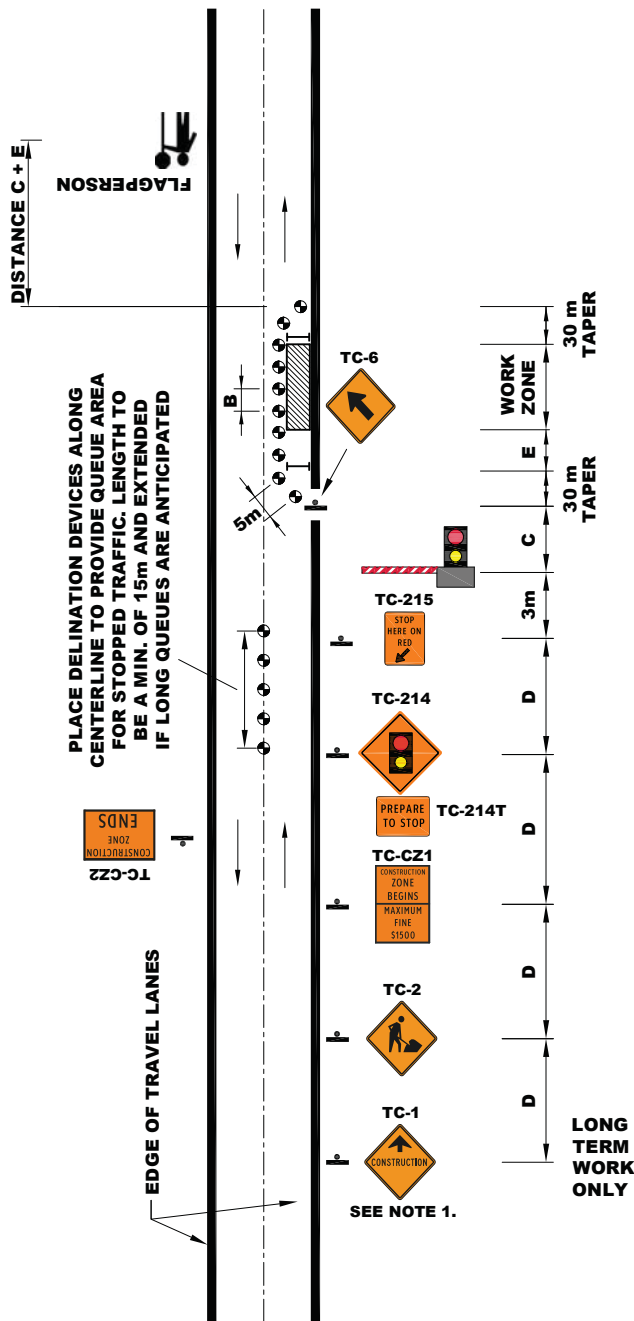

WORK ZONE DIMENSIONS FOR LANE CLOSED SPEED LIMIT LESS THAN OR EQUAL TO 60 km/h

DIMENSION (m)	NORMAL POSTED REGULATORY SPEED			
	50	60		
A	30	40		
B	5/8	5/12		
C	30	40		
D	50	50		
E	35	50		

POSTED SPEED IS EXISTING SPEED LIMIT (km/h)

A - TAPER LANE WHEN NO LANE CONTROL PRESENT

B - MAX. DELINEATOR SPACING IN TAPER/WORK ZONE

C - TRAFFIC CONTROL PERSON SETBACK (m)

D - DISTANCE BETWEEN CONSTRUCTION SIGNS

E - BUFFER AREA LENGTH BETWEEN TAPER AND WORK ZONE

NOTES

1. ONLY WHERE THE DURATION OF THIS ACTIVITY IS DEFINED AS "LONG TERM WORK" SIGN TC-1 SHALL BE INSTALLED.
2. NOT APPROVED FOR USE DURING NIGHT TIME OPERATIONS. PLEASE REFER TO LAYOUT 752-4.

792-1

TRAFFIC CONTROL MANUAL

2018

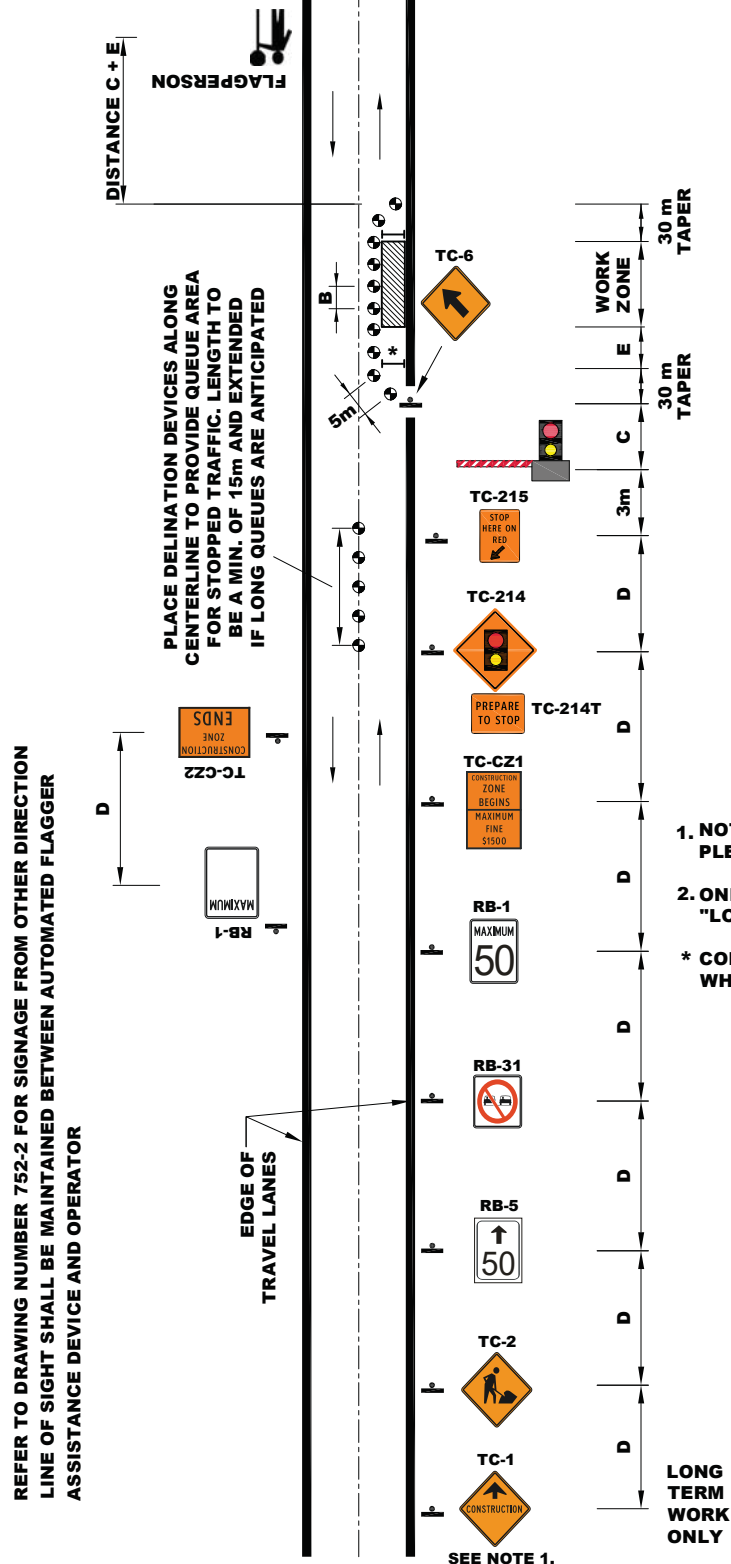

WORK ZONE DIMENSIONS FOR ONE LANE CLOSED SPEED LIMIT OVER 60 km/h

DIMENSION (m)	NORMAL POSTED REGULATORY SPEED			
	70	80	90	100
A	60	90	110	180
B	5/15	5/15	5/18	5/20
C	40	50	50	50
D	75	100	100	150
E	50	75	75	75

- POSTED SPEED IS EXISTING SPEED LIMIT (km/h)
- A - TAPER LANE WHEN NO LANE CONTROL PRESENT
 - B - MAX. DELINEATOR SPACING IN TAPER/WORK ZONE
 - C - TRAFFIC CONTROL PERSON SETBACK (m)
 - D - DISTANCE BETWEEN CONSTRUCTION SIGNS
 - E - BUFFER AREA LENGTH BETWEEN TAPER AND WORK ZONE

NOTES

1. NOT APPROVED FOR USE DURING NIGHT TIME OPERATIONS. PLEASE REFER TO LAYOUT 752-4.
 2. ONLY WHERE THE DURATION OF THIS ACTIVITY IS DEFINED AS "LONG TERM WORK" SIGN TC-1 SHALL BE INSTALLED.
- * CONTROL VEHICLE WITH "FAB" OR STAND-ALONE FAB REQUIRED WHEN CLOSING A LANE ON A BRIDGE STRUCTURE.

792-2

TRAFFIC CONTROL MANUAL 2018

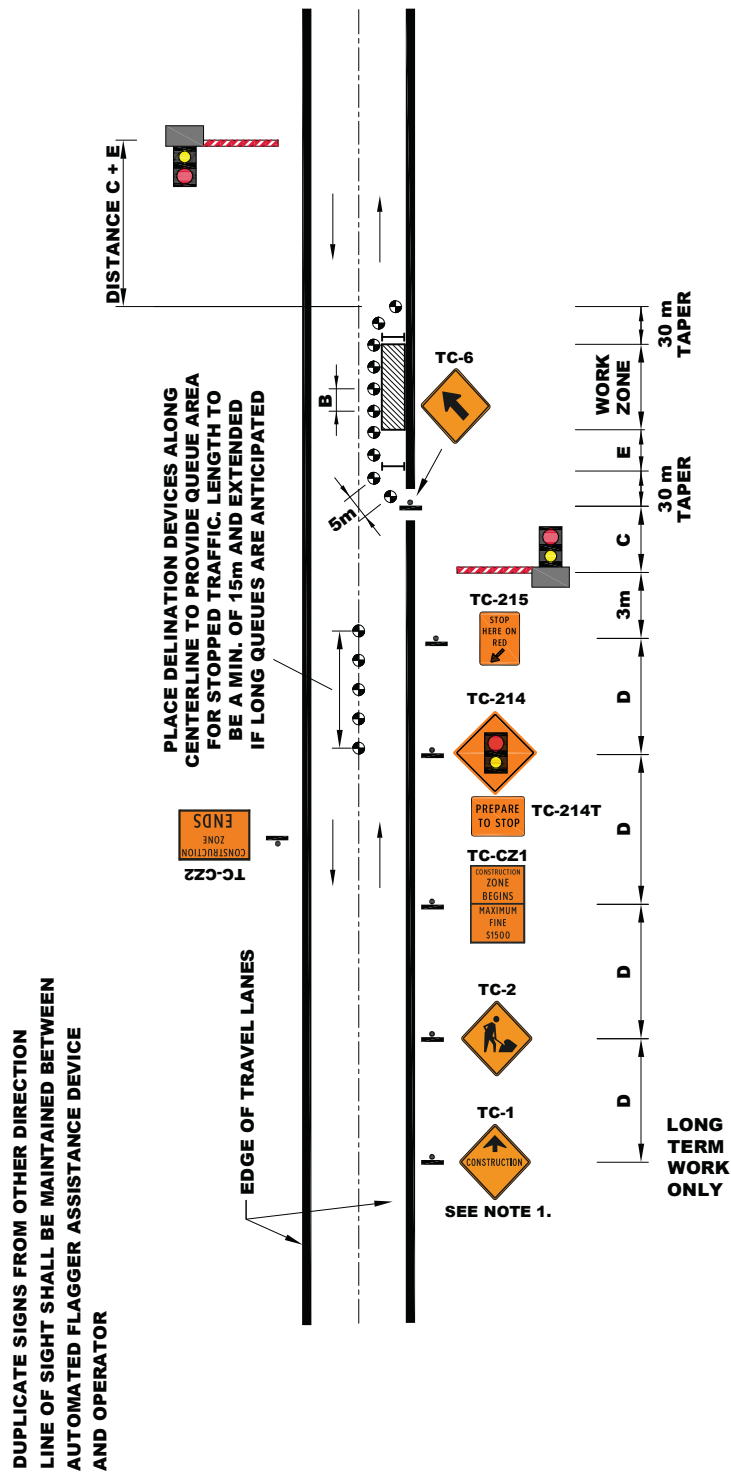

**WORK ZONE DIMENSIONS FOR
LANE CLOSED SPEED LIMIT LESS
THAN OR EQUAL TO 60 km/h**

DIMENSION (m)	NORMAL POSTED REGULATORY SPEED			
	50	60		
A	30	40		
B	5/8	5/12		
C	30	40		
D	50	50		
E	35	50		

POSTED SPEED IS EXISTING SPEED LIMIT (km/h)

A - TAPER LANE WHEN NO LANE CONTROL PRESENT

B - MAX. DELINEATOR SPACING IN TAPER/WORK ZONE

C - TRAFFIC CONTROL PERSON SETBACK (m)

D - DISTANCE BETWEEN CONSTRUCTION SIGNS

E - BUFFER AREA LENGTH BETWEEN TAPER AND WORK ZONE

NOTES

1. ONLY WHERE THE DURATION OF THIS ACTIVITY IS DEFINED AS "LONG TERM WORK" SIGN TC-1 SHALL BE INSTALLED.
2. NOT APPROVED FOR USE DURING NIGHT TIME OPERATIONS. PLEASE REFER TO LAYOUT 752-4.

792-3

TRAFFIC CONTROL MANUAL 2018

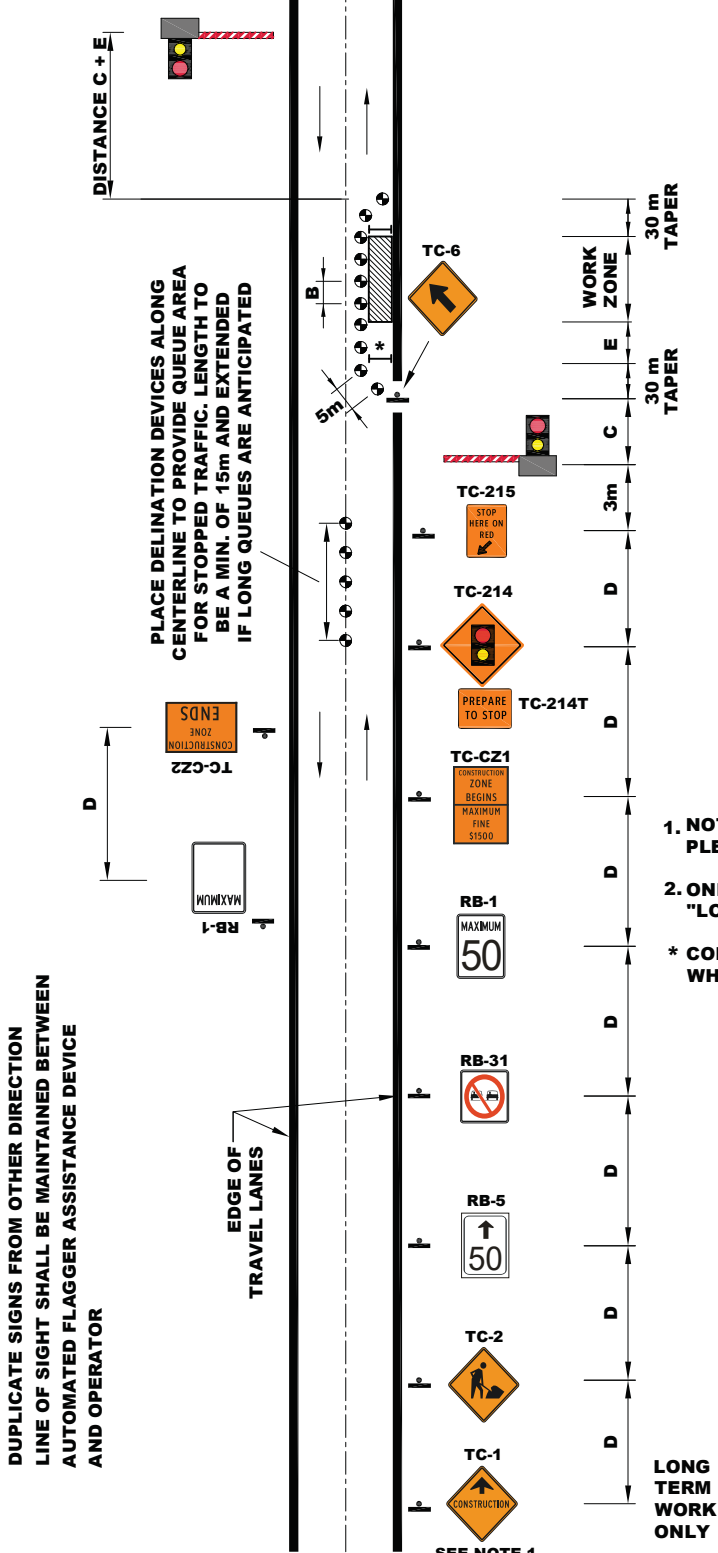

WORK ZONE DIMENSIONS FOR ONE LANE CLOSED SPEED LIMIT OVER 60 km/h

DIMENSION (m)	NORMAL POSTED REGULATORY SPEED			
	70	80	90	100
A	60	90	110	180
B	5/15	5/15	5/18	5/20
C	40	50	50	50
D	75	100	100	150
E	50	75	75	75

- POSTED SPEED IS EXISTING SPEED LIMIT (km/h)
- A - TAPER LANE WHEN NO LANE CONTROL PRESENT
 - B - MAX. DELINEATOR SPACING IN TAPER/WORK ZONE
 - C - TRAFFIC CONTROL PERSON SETBACK (m)
 - D - DISTANCE BETWEEN CONSTRUCTION SIGNS
 - E - BUFFER AREA LENGTH BETWEEN TAPER AND WORK ZONE

NOTES

1. NOT APPROVED FOR USE DURING NIGHT TIME OPERATIONS. PLEASE REFER TO LAYOUT 752-4.
 2. ONLY WHERE THE DURATION OF THIS ACTIVITY IS DEFINED AS "LONG TERM WORK" SIGN TC-1 SHALL BE INSTALLED.
- * CONTROL VEHICLE WITH "FAB" OR STAND-ALONE FAB REQUIRED WHEN CLOSING A LANE ON A BRIDGE STRUCTURE.

792-4

TRAFFIC CONTROL MANUAL 2018

NOTE: ALL SIGNS TO BE REPEATED ALONG THE SHOULDER OF THE LANE ADJACENT TO THE MEDIAN

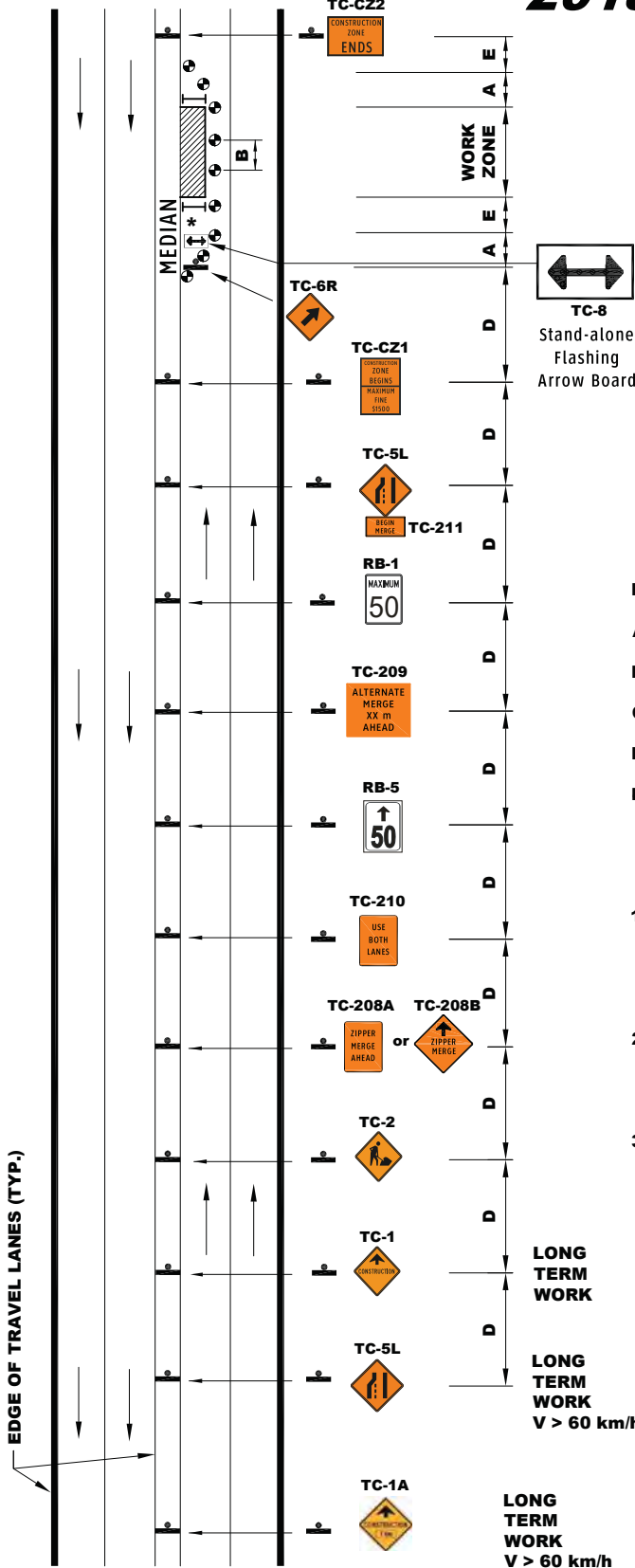

WORK ZONE DIMENSIONS FOR LEFT LANE CLOSED DIVIDED HIGHWAY LONG DURATION

DIMENSION (m)	NORMAL POSTED REGULATORY SPEED					
	50	60	70	80	90	100
A	30	40	60	90	110	180
B	5/8	8/12	10/15	10/15	12/18	15/20
C	30	40	40	50	50	50
D	50	50	75	100	100	150
E	35	50	50	75	75	75

POSTED SPEED IS EXISTING SPEED LIMIT (km/h)

A - TAPER LANE WHEN NO LANE CONTROL PRESENT

B - MAX. DELINEATOR SPACING IN TAPER/WORK ZONE

C - TRAFFIC CONTROL PERSON SETBACK (m)

D - DISTANCE BETWEEN CONSTRUCTION SIGNS

E - BUFFER AREA LENGTH BETWEEN TAPER AND WORK ZONE

NOTES

- WHERE THE DURATION OF THIS ACTIVITY IS DEFINED AS "LONG TERM WORK", AND THE REGULAR POSTED SPEED LIMIT IS GREATER THAN 60 km/h PROVIDE AN ADVANCE CONSTRUCTION AHEAD 1 km AND AN ADDITIONAL LEFT LANE ENDS SIGN TC-5L.
- WHERE THE REGULAR EXISTING SPEED LIMIT IS 50 km/h OR LESS, SPEED SIGNS ARE NOT REQUIRED. REDUCE POSTED SPEED IF HAZARD ASSESSMENT INDICATES SPEED REDUCTION REQUIRED.
- A VARIABLE MESSAGE SIGN MAY BE PLACED IN ADVANCE OF THE LANE CLOSURE TO INFORM MOTORISTS OF ALTERNATING MERGE AHEAD. REFER TO SECTION 9.0 OF THE TRAFFIC CONTROL MANUAL.

* CONTROL VEHICLE WITH "FAB" REQUIRED WHEN CLOSING A LANE ON A BRIDGE STRUCTURE.

793

TRAFFIC CONTROL MANUAL 2018

CONSTRUCTION DISTANCE TABLE

WORK ZONE DIMENSIONS FOR CONSTRUCTION DISTANCE TABLE						
NORMAL POSTED REGULATORY SPEED						
DIMENSION (m)	50	60	70	80	90	100
A	30	40	60	90	110	180
B	5/8	8/12	10/15	10/15	12/18	15/20
C	30	40	40	50	50	50
D	50	50	75	100	100	150
E	35	50	50	75	75	75

POSTED SPEED IS EXISTING SPEED LIMIT (km/h)

A - TAPER LANE WHEN NO LANE CONTROL PRESENT

B - MAX. DELINEATOR SPACING IN TAPER/WORK ZONE

C - TRAFFIC CONTROL PERSON SETBACK (m)

D - DISTANCE BETWEEN CONSTRUCTION SIGNS













E - BUFFER AREA LENGTH BETWEEN TAPER AND WORK ZONE

799-1

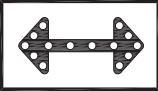

TRAFFIC CONTROL MANUAL 2018

LEGEND

	Work Area
	Sign
	Sign
	Delineator
	Traffic Cones or Delineator Posts
	Chevron
	Barrels
	Barricade
	Control Vehicle
	Service Vehicle
	Stand Alone Flashing Arrow Board (TC-8)
	Vehicle Mounted Flashing Arrow Signals for Control Vehicles (TC-9)

799-2

APPENDIX 1

TEMPORARY TRAFFIC CONTROL FOR INCIDENT MANAGEMENT

APPENDIX 1: Temporary Traffic Control for Incident Management

1.0 Introduction

1.1 SCOPE

Traffic control during incident management is necessary for any unplanned event such as accident scenes, towing recovery of vehicles or medical emergencies, etc. Traffic control measures assist with securing the scene, protects all road users including the responders, and provides workers on the scene a safe an environment to carry out necessary procedures.

This appendix provides guidelines to incident responders for needed resources such as personal protective equipment, traffic control devices and staging procedures with typical layout procedures in a step by step fashion. These guidelines are provided for operations personnel and the successive responders who would be responsible for establishing and maintaining, changing and removing any traffic control in response to control of traffic operations at an incident scene or any other type of unplanned event. The guidelines provided herein are based on the fundamental principles and concepts related to traffic control presented in the Traffic Control Manual (TCM). Users of this resource should be familiar with both the TCM and this appendix in applying these guidelines. The following table identifies possible first responders and their roles and responsibilities for traffic control.

Response Agency	Typical Roles & Responsibilities in Traffic Control
911 & Other Dispatchers	<ul style="list-style-type: none"> • Receive 911 calls from land lines, cell phones, and other sources. • Dispatch appropriate response agencies
Law Enforcement (Federal, Provincial, and Municipal agencies)	<ul style="list-style-type: none"> • Assist in incident detection and verification • Determine severity of incident and relay information to dispatchers • Isolate and secure incident scene • Setup initial traffic control devices • Determine additional personnel/equipment required to respond • Supervise scene clearance • Direct traffic • Identify requirements for crash investigations

<p>Fire Rescue(carrier and/or volunteer fire departments)</p>	<ul style="list-style-type: none"> • Protect and contain incident scene • Assist in direction of traffic (only if proper flagpersons course completed) • Provide initial hazardous material response and/or request additional clean-up resources • Assist in incident clearance
<p>Emergency Medical Services</p>	<ul style="list-style-type: none"> • Protect and contain incident scene when first on the scene • Determine destination and transportation requirements for the injured • Coordinate evacuation with firefighters, police, ambulance staff, or airlift personnel • Transport incident victims
<p>Department of Transportation or Municipal Road Authority Personnel (or agent) -Maintenance Division</p>	<ul style="list-style-type: none"> • Assist in incident detection and verification, communicate with emergency services • Provide initial and longer-term traffic control when emergency responders have vacated the incident scene. • Provide special equipment or resources as required • Contain minor spills if possible • Coordinate with law enforcement possible alternate routes • Operate intelligent transportation systems (ITS) devices per approved procedures • Provide traveler information to communications staff, public or media • Dispatch service inspection staff • Notify other agencies of incident as required • Assess infrastructure damage
<p>Department of Transportation or Municipal Road Authority Personnel (or agent) -Construction Division</p>	<ul style="list-style-type: none"> • Similar to Maintenance Division personnel, but within a work zone • Coordinates with contractor for traffic control and repairs
<p>Towing and recovery</p>	<ul style="list-style-type: none"> • Assist in incident detection and verification • Secure incident scene if capable to do so • Assist with and relocate disabled vehicles • Provide containment of minor spills • Clear the scene

1.2 DEFINITION OF UNPLANNED EVENTS

Temporary traffic control for construction, maintenance or scheduled road activities allows for planned setups, recording and application of the fundamental principles of traffic control as detailed in the TCM. An unplanned event would be any incident that occurs without advance notice of time and location which disrupts normal traffic flow and/or presents a hazard to road users. An unplanned event requires prompt scene management by all responders to the scene.

Unplanned events include the following situations:

- Unplanned infrastructure issues such as water main breaks, fallen poles or signs, bridge/road washout;
- Vehicle(s)/road user collision;
- Vehicle breakdown;
- Debris on roadway – either from nature, objects, spills, and;
- Off roadway incidents that affect traffic

1.3 TRAFFIC CONTROL GUIDELINES

It is very difficult to establish a clearly defined traffic control zone under emergencies or other unplanned situations, particularly in the first moments after the incident. Initial security of the event scene takes time which will involve a progressive process based on available personnel, equipment and the critical needs of the incident. Traffic control operations can vary as the incident response progresses requiring changes as responders arrive and carry out their duties. The following table describes possible progression of traffic control.

Progression of On-Scene Traffic Control

Stage	Actions/Responses
Arrival	<ol style="list-style-type: none"> 1. Ensure all emergency lights are operating as you approach the scene 2. Conduct an initial scene survey to identify hazards and evaluate the situation. 3. At any incident where there is encroachment into a live traffic lane, only person(s) qualified under the Highway Traffic Act (HTA) can provide temporary traffic control. If not already present, the appropriate police agency and/or road authority shall be notified that traffic control is required. All other response vehicles shall park in a safe location until initial traffic control is established. 4. Begin the establishment of an emergency traffic control zone by slowly coming to a stop and positioning the emergency response vehicle to provide initial safety to the scene. 5. All personnel who leave emergency vehicles must wear appropriate safety equipment.

Initial Set up	<ol style="list-style-type: none"> 6. When practical, place cones and/or flares to form an initial taper with devices on hand. 7. Position additional responder vehicles to enhance establishment of traffic control zones or direct to park in an appropriate location. 8. If required, call for additional resources to secure the scene (i.e. road authority, “safety support vehicle”, additional traffic control devices, etc.)
Enhanced Traffic Control	<ol style="list-style-type: none"> 9. Place appropriate advisory signs in the advance warning area as soon as possible. 10. Expand taper and cone placements for road conditions and estimated on the scene time. 11. If required, utilize appropriate person(s) to direct traffic and other available traffic control devices.
Ongoing Traffic Control	<ol style="list-style-type: none"> 12. When an extended duration scene is anticipated, additional traffic control devices shall be provided as shown in the TCM for a planned event of the expected duration (short or long duration). 13. All safety procedures must remain in place until the incident is resolved (all personnel, hazards, emergency and related vehicles, and equipment are removed from the roadway).

The first priority on arrival is to establish initial traffic control that provides a safe work area for responders and minimizes the chance of secondary crashes.

Traffic control device placement is affected by expected duration of the incident, location, prevailing traffic conditions (i.e. volume, speed, vehicle type), weather, and visibility. Upon arrival, responders should make an estimate of the magnitude of the incident and then estimate the expected duration for recovery. Traffic control can then be progressively established based on these assessments. Recommended staging sequence to follow would be as follows:

1. Establish full roadway closure followed by
2. Directional lane closure then
3. Multiple lanes operation then
4. Single lane affected only then to
5. Shoulder closure until the incident is fully resolved and traffic flow returns to normal.

The initial road closure should only be as required to ensure protection of the scene. An example would be in a multilane highway where only several lanes needed to be closed the progressive staging could start at point 3 above.

Roadway lane closures should be managed so that only the lanes which are absolutely necessary are closed to protect responders, victims, and investigation are completed. Every effort should be made to minimize the amount of time these lanes are closed or an alternate route is provided. The number of closed lanes may change several times during incident clearance efforts. Associated traffic control operations should be established and monitored/changed to fit the changing conditions.

As additional traffic control devices/equipment arrive on scene, traffic control operations should be adjusted to a TCM layout/ scenario compliant setup.

1.4 UNIFIED INCIDENT COMMAND SYSTEM

Command has to be established from the first arriving responder. The responsibility of the incident commander is to stabilize the environment, the incident scene, and any patients before beginning operations. Depending on the availability of emergency responders, the typical first arriving responder could vary among jurisdictions. The incident commander may change between the first responders as the incident progresses. Handover of incident command could change as per the following examples:

1. The incident commander is more appropriately Emergency Medical Staff when medical treatment as required for patients where no extrication is required and there is no risk of fire (or other safety hazards, but significant resources are required to transport the injured).
2. The incident commander is appropriately the fire department when extrication is required or there is a risk of fire.
3. The incident commander is appropriately the police agency when the patient has been stabilized or transported from the scene and original fire hazards extinguished. The focus of command reverts to expediting traffic flow while cleanup and towing operations get underway. (i.e. perimeter safety of all parties and expediting traffic flow)

It is recommended all first responder organizations within a jurisdiction develop an incident command protocol.

2.0 Guidelines for First on the Scene

2.1 IDENTIFICATION OF HAZARDS AND SCENE EVALUATION

The first responder to an incident or unplanned event should conduct an initial scene survey to identify site specific hazards and evaluate the situation. Placement of vehicles and traffic control devices will be impacted by the specific conditions of the event location. The purpose of traffic control is to provide protection to the responders and give guidance to the road users. All potential hazards to responders or road users should be identified and traffic control provided accordingly. Hazards that affect traffic control include but are not limited to:

- Poor visibility due to weather conditions
- Visibility constraints due to light conditions – night/day, sun rise & set, street lighting
- Limited or obstructed sight lines due to hills, curves, trees, signs, vehicles, bridges, etc.

- Available road user reaction time due to site conditions (fog, wet, ice, snow)
- Road surface type - gravel, paved, construction stage
- Prevailing traffic conditions – speed, traffic volume, vehicle types
- Estimated on-scene time.

2.2 ESTIMATED ON-SCENE TIME – EXTENDED DURATION SCENE

The first responder to an incident or unplanned event should make an estimate of the expected on-scene time and determine if available resources are sufficient to maintain traffic control for the entire duration and stages of the event. (i.e. vehicles, cones/flares, personnel). Additional resources should be requested as soon as possible.

Extended duration incident scenes typically involve dealing with fatal and injury crashes involving numerous vehicles which often contain hazardous materials which may result from natural or human made situations. These incidents typically involve complete or partial closure of a roadway feature for a period of time exceeding two hours.

Examples of these types of incidents include:

- Bridge and culvert washouts
- Vehicle crashes either single or multiple
- Rock slides or land slides
- Load loss which may involve hazardous or environmental clean-up
- Utility troubleshooting (downed utility lines)
- Forest fires or other roadside infringement.

If extended road closure or incident management is anticipated additional equipment, vehicles and personnel must be deployed to provide temporary traffic control as identified in the Traffic Control Manual.

2.3 FIRST ON-SCENE – SERVICE/TOW VEHICLES

Only the Minister of Transportation or his designates are permitted to close a roadway and direct traffic as identified in the Highway Traffic Act. If emergency responders are first on the scene they should block lanes that have been effectively closed by the incident as required to protect the incident area until the other incident responders arrive. The appropriate policing agency should be notified that traffic control is required at any incident where there is encroachment or blockage of live lanes of traffic. All other response vehicles should park in a safe location until initial traffic control is established.

3.0 Equipment and Devices

3.1 HIGH VISIBILITY SAFETY APPAREL (HVSA)

All emergency responders who set up or remove traffic control devices, direct traffic, or work within 3 meters of a live lane of traffic shall wear high visibility safety apparel (HVSA). The HVSA must have reflective and fluorescent materials which meet the requirements of the Occupational Health and Safety Act and Regulations Section 81/12. Canadian Standards Association (CSA) Standard Z96-09 provides additional recommendations for the selection of appropriate high visibility safety apparel and other features of the garments by a classification system numbered from 1 to 3. Emergency responders are recommended to use Class 2 or 3 HVSA for better performance in their working environments.

Any headwear worn is also recommended to be high visibility headwear by including retro-reflective materials and fluorescent or bright colour background materials to provide full 360 degree visibility. Any materials attached to protective headwear should not affect the protective ability of the headwear. Emergency response personnel headwear should meet the requirements of the applicable National Fire Protection Association Standard (OHS Reg 74/12).

Selection, use and maintenance of personal protective equipment including high visibility safety apparel are important to ensure high visibility. This is covered by OHS Reg 71/12. Garments which are worn, torn, soiled or contaminated should be replaced to ensure acceptable levels of visibility are maintained.

3.2 VEHICLE LIGHTS AND FLARES

Flashing lights on emergency response vehicles are used to enhance the safety of response personnel and incident victims, and are essential in the initial response stage. Historically the lights have been red, blue and amber and recent advances in LED technology include many more features such as various flash patterns and strobe capabilities. Flashing lights, high intensity rotating, flashing, oscillating, or strobe light systems mounted outside and inside of emergency response vehicles provide visibility and immediate information to road users of an immediate emergency situation. Use of flashing lights must comply with the guidelines in the Highway Traffic Act.

Too many warning lights however could be confusing to drivers. In consideration of this, flashing lights should be used with caution and discretion to minimize the impact on traffic flow. Once good traffic control is established at an incident scene it is recommended, where practical, use of flashing lights be reduced such that the following be observed:

- Only amber, rather than red and blue warning lights be used once TCM compliant traffic control layout is in place, particularly for extended periods of traffic control. If

visibility issues, such as fog or darkness, deem necessary red/blue lights may be continued;

- The number of lights be minimized to avoid creating glare for motorists and reduce the “rubber necking” behavior effect;
- Forward facing (into on-coming traffic) emergency lighting should be reduced or eliminated. Emergency response vehicles should be capable of turning off headlights when the responder determines it is necessary;
- Emergency response vehicles should have day and night brightness settings for vehicle lights;
- Tow vehicle beacons should be deactivated when no longer needed to protect workers or public. (i.e. after the vehicle is travelling with the traffic stream).

In addition to the use of emergency vehicle placement as an initial traffic control setup, the responders should carry sufficient emergency flares which can be used to setup a temporary lane closure taper until other devices, such as traffic cones or candles, can be placed. Flares, or other illuminated warning devices, are especially useful in night time incidents to warn motorists of lane changes as the bright red lights of the flares tend to visually merge. Flares may also serve to supplement the visibility of traffic cone placement in night conditions when they warn oncoming traffic and illuminate traffic cones. E-Flares are a recommended alternative to disposable flares.

3.3 INCIDENT SIGNS

Temporary condition signs should be used to notify oncoming traffic that the normal flow of traffic may be impeded due to the result of (1), an incident (crash) on or near the roadway ahead, and/or (2) removal of disabled vehicles on, or back on to the roadway by tow trucks.

Note that the use of “Incident Ahead” signs is not intended to replace any existing safety devices or practices that enforcement agencies now use, but rather to supplement them by giving motorists advance notice of what is occurring ahead, to expect emergency responders on the roadway, and to proceed with caution as full temporary traffic control may not yet be established.

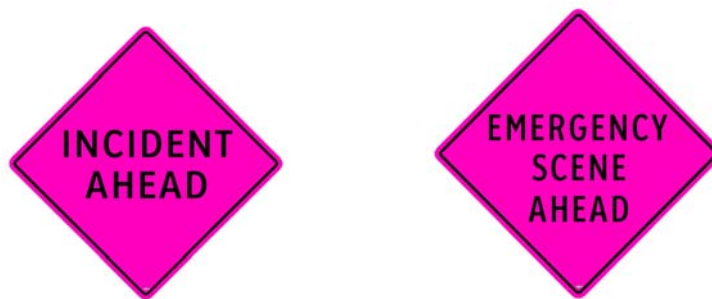

“Incident Ahead” or “Emergency Scene Ahead” signs should be placed on the shoulder of the road, in accordance with “Lane Closed” diagrams in section 752 of the TCM, by a first responder. (Fire Dept., Police Agency, Road authority or its contracted agent, or Towing

Operator). The sign should be placed in advance of the incident scene so that approaching vehicles will have time to slow down before reaching the incident scene. The sign must be retro-reflective high intensity prismatic and designed to comply with sign specifications regarding shape, colour, size, and must be kept clean and legible at all times. Signs must be printed on either aluminum, plywood, or roll-up flexible fabric reinforced material. The sign may be setup quickly by using portable lightweight spring stands or other appropriate temporary mounting at the incident site. Situations where incidents occur near a corner, hill or other reduced visibility situations would require adjustment of the advance warning device.

Incidents on high speed roadways, including undivided and divided highways, should have advance warning signs placed, where practical, approximately 180 meters in advance of where the vehicles would have to veer from their usual travel lane to bypass the incident scene. (This area is referred to as the taper). Warning signs should be placed at least 1.0 meter from the edge of the travelled lane.

Warning signs on other types of roadways should be placed approximately 60 meters in advance of the taper from the normal travel lane for speeds of 60 km/h or less and 100 meters in advance of the taper for speeds above 60 km/h. Signs should be placed 0.5 to 2.0 meters from the edge of the travelled lane.



Additional signs as shown in Section 752 of the TCM should be placed where incidents would require long term diversion of traffic from the normal path of vehicle travel.

3.4 DELINEATION DEVICES

Delineation devices shall be used to channelize traffic when the traffic flow is impeded as a result of incidents and there is a narrowing of the roadway. They form part of the general category called Traffic Control Devices and shall be used as supplementary traffic control by providing a smooth and gradual transition in shifting traffic from one lane to another, into a detour, or in reducing lane width of the travelled way. These channeling devices may also be used to separate traffic from the incident area.

When the incident condition exists during darkness, delineation shall be achieved by the use of traffic cones, delineator posts, flashing beacons or similar devices. In all cases, markers used to achieve delineation during the hours of darkness shall be retro-reflectorized using

high intensity grade sheeting to show the same color and shape by night as by day. **Fluorescent paint shall not be used as a reflectorized substitute and is not acceptable.**

Delineators shall be in reasonable condition to be effective for both day and night conditions. While delineation devices cannot always be in new condition, they should always be in reasonable condition. Unacceptable conditions that warrant replacing shall be those which are: covered in splatter, dirt, dust or snow; have several large abrasions or tears; missing letters; have deformation or are dented considerably; have colour fading or loss of more than 20% of its reflectivity.

3.4.1 LOCATION OF DELINEATION DEVICES

Any incident activity on or within 1 m of a roadway shall be marked by delineators along the site and the approaches to the work site or obstruction. The angle at which the delineators are placed across the closed portion of the road is called the taper and should vary according to the road type as shown in the following diagrams at the end of the appendix.

If the incident area affects more than one traffic lane width, each traffic lane shall be closed with consideration of using additional support vehicles (that have appropriate lighting and flashing arrow boards) in higher speed areas to protect the incident area as shown in the multi-lane diagrams at the end of this appendix.

3.4.2 SPACING OF DELINEATORS

The centre to centre distance between delineators varies with the regulatory speed and road type. Refer to the following diagrams at the end of the appendix for each layout.

3.4.3 DELINEATOR POSTS

Delineator posts used to channelize or delineate traffic shall be 1100 mm in height and 100 mm in diameter. The markings consist of two white high intensity reflective bands 75 mm in width. Unit is weighed down with a standard 6.8kg (15lb) rubber base. Additional 6.8kg (15lb) base inserts may be necessary to prevent toppling in adverse weather conditions and can be used when required by wind conditions.



3.4.4 TRAFFIC CONES

The dimensions of traffic cones is related to the normal maximum posted speed on the roadway and their height comply with the following minimum requirements.

Maximum Speed (km/h)	Minimum Height (mm)
50 km/h or less	450
Greater than 50 km/h	700



3.5 MANUAL TRAFFIC DIRECTION

Manual traffic direction may need to be provided by qualified personnel (traffic control persons (TCP)) or the police agency during the initial phase of the response. Normally the TCP is one of the responding law enforcement personnel, but could also be the fire or road authority (or agent) or a trained TCP from a recognized WHSCC training program. TCPs may be used to guide traffic when:

- Travel lanes are wholly or partially blocked;
- The road shoulder must be used to bypass the incident scene; or
- Only one lane is available for two way traffic.

It is important that the person directing traffic always faces the traffic, wears the appropriate prescribed PPE or highly visible safety apparel, and directs traffic away from and safely around the incident by using large extended, and consistent gestures to convey the required actions to drivers. Where available, STOP/SLOW paddles or a signaling baton flashlight flash light are preferred for directing traffic. Refer to pages 23 to 29 in the TCM for more details on the procedure for manual traffic direction.

When resources permit, a dedicated traffic observer may be utilized to monitor traffic and activate an emergency signal if the actions of a motorist do not conform to established traffic control measures in place at the incident scene. The use of a portable air horn or similar device is suggested as an emergency signal to road users and emergency personnel.

3.6 STAND ALONE FLASHING ARROW BOARD

Arrow boards are additional traffic control devices used where a lane is closed and traffic must merge with other traffic in adjacent lanes. These devices shall be brought to an incident site at a later stage as full compliance with temporary traffic control layouts in the TCM is required and established.

The arrow board shall be a minimum size, 1200 mm in width by 600 mm in height, and shall be of a type and design as approved by the Department of Transportation & Works.

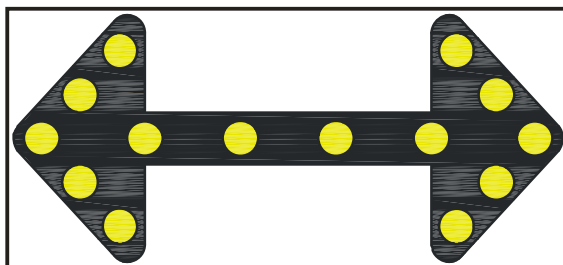

Arrow boards that do not comply with this specification should be considered supplemental, with sufficient additional traffic control devices provided to guide the road users.

3.7 VEHICLE MOUNTED FLASHING ARROW SIGNALS FOR CONTROL VEHICLES

Flashing arrow signals shall have a minimum arrow head height of 600mm (760mm maximum) and a minimum length of 1500mm. See diagram below. These arrow signals shall consist of an array of a minimum of fourteen (14) AMBER high intensity LED lights, with each light being 100mm in diameter, providing a minimum legibility distance of 600m. The AMBER arrow signals shall be on a black background.

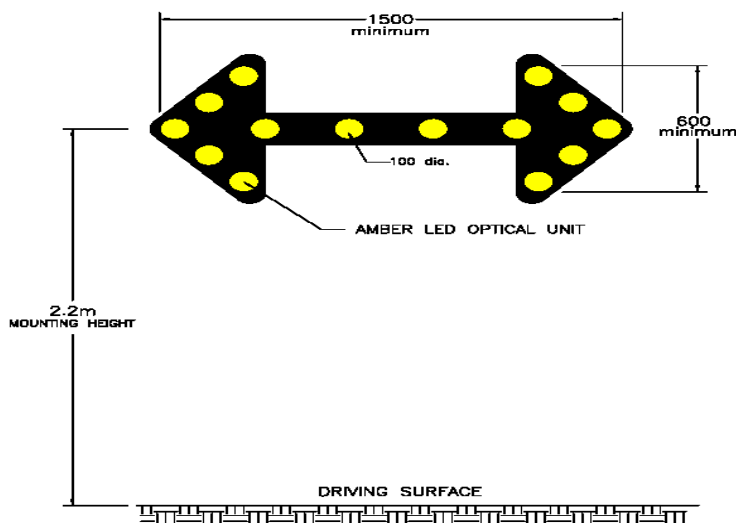

3.8 CONTROL VEHICLE

Risks increase for emergency responders on roads where post speeds increase. On roadways with posted speed limits of 70 km/h or greater a control vehicle should be considered for additional traffic control. Control vehicles function as a warning device to oncoming motorists by blocking the lane or parking on the shoulder. Control vehicles used during incident traffic control shall be equipped with a vehicle mounted flashing arrow board (see specifications above). In addition, the vehicle shall be equipped with a strobe light, standard four-way flashers and two bumper mounted signs, being 150mm high x 450mm long, with orange and black alternating and opposite stripes at 45°. The signs shall be reflectorized to indicate the same shape and color by day or night. See page 38 of the TCM

Personnel who operate a Control Vehicle may also be required to:

- Assist crews on the scene;
- Outline the perimeter of the incident scene or secure the site;
- Setup any additional required safety equipment;
- Establish traffic space and/monitor traffic flow; and
- Block additional traffic lanes as required.

3.9 CRASH TRUCKS AND ATTENUATORS

Heavy trucks or trailers with rear-mounted energy adsorption attenuation equipment, become a traffic control device when parked to protect a work zone or incident area. The crash truck should be placed upstream from the incident work space with the wheels cut toward the shoulder. It should not be occupied by anyone as its purpose is to protect the work/incident area by taking any hit before an errant vehicle can enter the area where emergency responders may otherwise be unprotected.

3.10 VARIABLE MESSAGE SIGNS

Variable Message Signs are electronic signs that are used to convey additional information about upcoming incidents or road work. These signs shall be used only as a supplement to, but not a substitute for, conventional temporary condition signs and devices. Their use in the traffic control shall be limited to installation either prior to, or within the advance warning area of the incident. The Highway Maintenance Division of the Department of Transportation and Works shall be contacted prior to the use of Variable Message Signs on provincially controlled highways.

Variable Message Signs may display either a single fixed message or a number of sequential messages. When programmed to display sequential messages, each message will be referred to as a phase. Each phase shall be visible to approaching motorists for a minimum of three seconds, and shall be able to be read at least twice by the approaching motorist. If sequential

messages exceed two phases, additional Variable Message Signs may be required. In this situation, the distance between Variable Message Signs shall be given careful consideration, based on the speed limit and the phase cycle, ensuring that the message(s) on each sign can be read twice by approaching motorists.

The following guidelines shall be used to determine the information to be displayed on Variable Message Signs:

- Messages shall consist of upper case text with a minimum letter height of 30cm.
- The messages shall be displayed in bright yellow or orange, providing a sharp contrast to the sign's black or dark blue/grey background colour.
- Each message shall convey a single, relevant and concise thought.
- Abbreviations shall only be used if they are easily understood.

Roadway incident/accident applications, where Variable Message Signs may be considered, include the following:

- On high speed, multi-lane roadways where significant delays, queuing or lane changes are anticipated for an extended period;
- On high volume roadways where complex and frequently changing alignment or surface conditions exist due to the incident conditions;
- Approaching an incident/accident where an alternate route may be available, but not apparent to approaching motorists.

Variable Message Signs shall be in reasonable condition to be effective for both day and night operation. While such devices cannot always be in new condition, they should always be in reasonable condition. Unacceptable conditions that warrant replacing shall be those which operate with less than 90% of the pixels in each character.

4.0 Incident Zone Structure and Progression of Traffic Control

The incident zone varies based on the scene location where it occurs but setup of the zone to perform the recovery and handle traffic in that process while it unfolds is typical in structure. The incident scene, when fully deployed, typically consists of: an approach area; a taper; a longitudinal or buffer zone; the incident area; and end section or return taper.

Figure 1-1

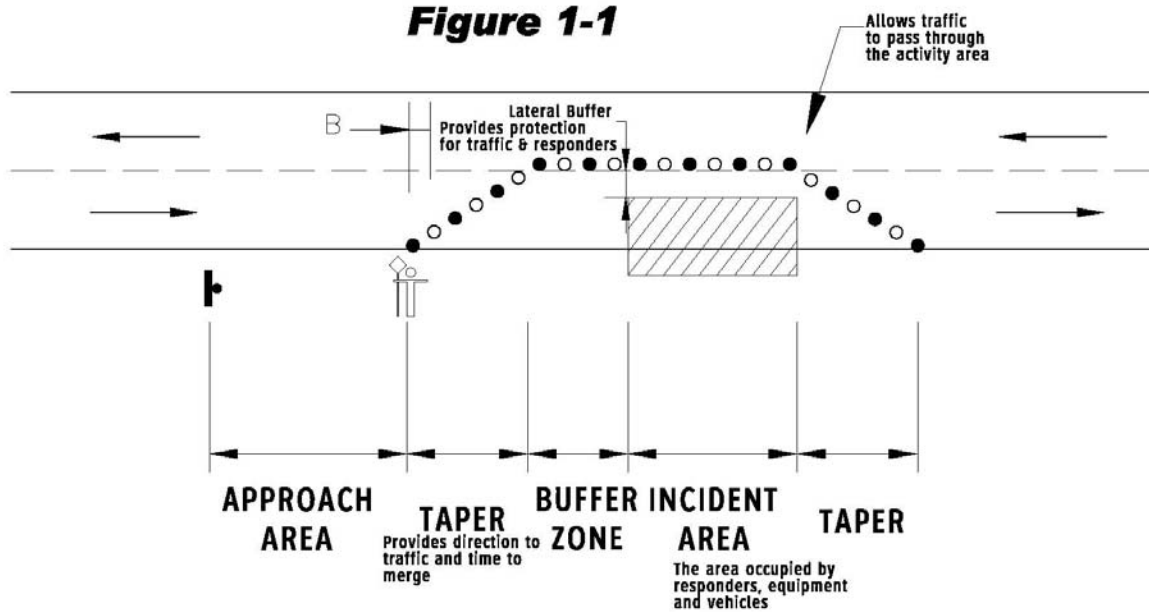

4.1 APPROACH AREA

Not all incidents will contain a formal approach area but it is typically the area where you would find the “Incident Ahead” signage and encounter a traffic control person when provided. For long duration incidents there may be other information, such as signage or message devices, provided to inform road users of the direction they should take to avoid the incident area.

4.2 TAPER AREA

The taper area is the part of the incident zone where road users are directed out of the normal path of travel through the use of cones, delineators, flares or vehicles in the fend off position.

Where an incident will interrupt traffic’s normal path of travel for any period of time or when traffic is moved from one lane to another, a taper through the use of traffic cones, should be setup as soon as practically possible. Where resources permit, a spotter or dedicated traffic observer should be employed during the setup a taper of traffic cones since exposure to traffic will occur by walking across a lane of traffic while deploying traffic cones, pylons or delineators. Traffic cone placement and retrieval should be carried out facing oncoming traffic.

Taper length for cone placement should be determined by regular posted speed. Typically higher posted speeds require longer tapers although it is recognized initial scene setup will evolve over time in relation to site specific and resource circumstances. A short taper of cones is better than no taper and an extension can be performed as time and resources permit. For instance an incident on a high speed roadway at the bottom of a hill will likely require a

longer taper of cones but will be deployed and manipulated as more supplies arrive on the scene.

It is recommended that emergency responding vehicles and towing operations be equipped with a minimum of six to eight traffic cones that comply with this document.

Key points to remember when setting up a taper include:

- A taper should encompass all equipment on the scene;
- Tapers should be setup to accommodate for sight obstacles;
- The taper should begin at the upstream end of the longitudinal buffer space;
- Maximize the space covered with the cones available; and
- Block as much of the roadway as needed and extend the taper out as far as possible to allow drivers adequate time to merge.

4.3 LONGITUDINAL BUFFER ZONE/SPACE

The longitudinal buffer space provides a space for protection between the taper area and the incident zone. This area should be free of vehicles, equipment and people. Cones should be placed along the edge of the buffer area to define a clear edge between the traffic and the buffer area. When a control vehicle or crash attenuator device is placed in advance of the incident area the buffer zone should be provided between the vehicle/device and the incident zone. Buffer zone lengths are shown in each of the diagrams following this Section.

4.4 INCIDENT AREA

The incident area is the section of the highway where response activities take place. Cones should be placed along the edge of the incident area, starting at the end of the buffer area. This action will define a clear definition of the traffic road user space and the incident activity area.

When necessary a lateral buffer space should be provided between the travel lanes and the incident area/space. The lateral buffer space is required when responders need room to work and provide further protection from errant vehicles. The amount of lateral buffer space in the incident zone is dependent on conditions such as: time of day; weather; road conditions; incident type; etc. lateral buffer space can encompass partial lanes or an entire lane and may require full use of the roadway requiring a complete roadway closure in order to properly perform duties.

Conditions Affecting Cone Placement

Cone placement should be adjusted (i.e. tapers lengthened, cones enhanced by flares) to account for the following situations:

Maximum Posted Speed

Roadway speed affects warning device placement due to:

- The distance travelled while reacting to the perceived hazard. A vehicle travelling 100 km/h moves 28 meters in one second. Higher speed require longer advanced warning/visibility and tapers;
- The distance required to stop a vehicle after the brakes have been applied. Higher travel speeds require a longer buffer space and taper.

View Obstructions

Obstacles can block a driver's view from seeing cones, traffic control devices, or hazards. View obstructions are different from reduced visibility conditions. Even during reduced visibility conditions an object may be partially visible and gradually becomes visible. View obstructions consist of:

- Horizontal view obstructions such as curves/embankments, hedges, trees, buildings, signs, utilities, vehicles;
- Vertical view obstructions such as crests of hills, bridges, signs, overpasses which affect the sight distance or the line of sight of drivers.

Reduced Visibility

Weather and darkness do not obscure a view in the same way as solid objects, but they reduce visibility. These conditions lessen the distance at which you can see things. Examples would include the following:

- Darkness or lack of lighting or even over-driving headlight range; and
- Weather such as fog, smoke, rain and snow or any combination of these factors. Darkness and weather combined together further reduce visibility. Motorists frequently have been known to drive too fast for conditions present with a reduced ability to react to an unexpected condition.

Glare

Glare temporarily blinds the field of vision of a motorist. The following are various types of glare which may affect perception and reaction time:

- Headlight glare at night from oncoming traffic;
- Fixed light glare from back lighting, illuminated signs and stationary vehicles; and
- Sun glare which may blind drivers and make objects invisible to the motorist.

Other Factors

A number of other conditions or factors that may affect cone placement include the following:

- Driver work load where a number of other surrounding traffic control devices, signals, or pavement markings and presence of emergency vehicles/control devices cause driver confusion ;
- Change in road alignment or features in advance of the incident scene. The road approach may include elevation change, curves, embankments, sudden change in road width, interchange ramps or intersection which could affect driver perception.

5.0 Positioning of Emergency Response Vehicles

Emergency vehicles should be parked in such a way that they protect incident responders and secure the scene by blocking traffic before additional traffic control devices arrive. Emergency vehicles should only block lanes as needed to work safely and efficiently, and should return the roadway to normal traffic flow as quickly as possible. Emergency vehicles should not unnecessarily impede traffic. Preferably all emergency vehicles should be parked on the same side of a roadway, in the same direction of the incident.

The fend-off position is the recommended method for positioning emergency vehicles at an incident that provides added protection to the scene from traffic. This position gives approaching motorists the best visibility of the emergency vehicle's side while allowing them to recognize the incident. The angle of positioning should be adequate to protect the incident area. This position would also tend to deflect any high speed impact that could otherwise crash into the incident scene. The vehicle positioning should also provide both a longitudinal and a lateral buffer space.

Vehicles not involved in traffic control and which do not protect the incident scene or the responders should be staged in a safe area. Their location should not create a traffic hazard or obstruction, or impede other emergency vehicles.

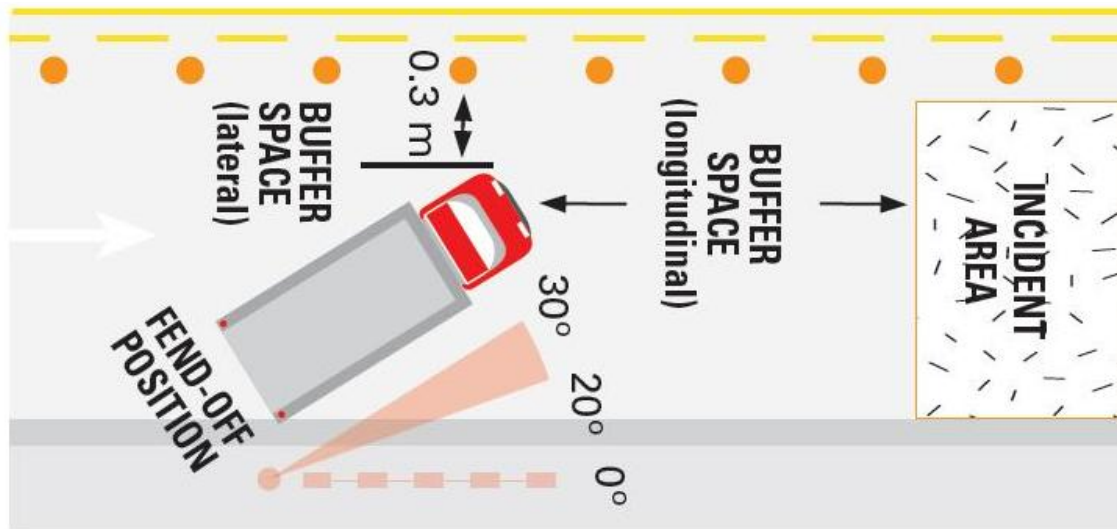

It is recommended that a buffer space be established between the incident area and emergency vehicles. The suggested distance is 4.0 meters for every 10 km/hr of posted speed limit. Reasons for this recommendation are as follows:

- If the emergency vehicle is hit from behind it may not be pushed into the original incident;
- Vehicle and equipment remains functional for firefighting operations;
- Scene preservation is maintained (crews will not drive inside the incident scene and destroy investigative evidence).

Lateral Buffer Space

Position the front and/or back bumper of the emergency vehicle at least 0.3 meters from the pavement markings of an active live traffic lane. This lateral buffer is used to reduce encroachments into the reserved traffic lanes. Traffic cones should also be placed on the skip line beside the emergency vehicle.

6.0 Situations that Require Special Attention

Traffic Control on High-Speed Highways

High Speed Highways present special problems for incident traffic control. Moving vehicles should always be considered a threat to safety. When working on high speed highways, extra care must be taken to ensure visibility and minimize exposure. Personnel should not remain in or position themselves beside vehicles that are closing a traffic lane. All lane closures should start from the nearest shoulder to the incident site and extend across as many lanes as required. Each lane should be closed as per the following diagrams. In the case of high speed roadways each lane closure should include protective control vehicles or emergency vehicles instead of just cones and/or flares.

Incident scenes on high speed roadways at the end of a curve or near the top of a crest would require lane closures well in advance of the view obstruction. This will provide oncoming traffic with adequate warning. On high speed highways additional advance warning traffic control devices may also be used on approach to lane closures.

Encroachment into Incident Space during Traffic Control Operations

In the case of errant vehicles entering the incident space the trained traffic direction personnel (either police or TCP's) are trained to operate, whenever possible, off the travelled portion of a highway and use a planned escape route. In the case of this type of occurrence the traffic direction personnel, when safe to do so, would return to their assigned position to advise other emergency responders to handle the new emergency as required. Such incidents, while not common, have been known to occur. Incident responders and traffic control personnel should be prepared for this type of occurrence.

7.0 Progression of Traffic Control

The following illustrations present the progression of traffic control for various scenarios as a guideline to first and secondary responders involved in incident response.

Figure 1-3 Incident on Shoulder (Non-Freeway)

Figure 1-4 Incident on Shoulder (Freeway)

Figure 1-5 Incident in Live Traffic Lane (Two-Lane Road)

Figure 1-6 Incident in Live Traffic Lane (Multi-Lane Non-Freeway)

Figure 1-7 Incident in Live Traffic Lane (Freeway)

APPENDIX 2

HAZARD ASSESSMENT PROCESS



11.2 HAZARD ASSESSMENT FORM

Reviewed Date: October, 2013
GOVERNMENT OF NEWFOUNDLAND AND LABRADOR
Department of Transportation & Works

Hazard Assessments must be completed prior to work being performed.
This form is to be completed in all workplaces.

Division/Region/Location:						
Activity/Job/Task Performed:						
Location of Activity:						
Date:						
#	Description of Hazard	Probability (1-3)	Severity (1-3)	Exposure (1-3)	Total	Rating L/M/H
#	How will the Hazard be controlled?	Action by:				

Assessment performed by: _____ Date: _____
Supervisor signature: _____ Date: _____

PROBABILITY (P) –
What is the likelihood of an incident caused by the hazard?
3 = will occur if not controlled
2 = likely to occur
1 = unlikely to occur

SEVERITY (S) –
If an incident does occur, what are the consequences?
3 = fatality/permanent disability or major property damage
2 = lost time injury or significant property damage
1 = first aid or minor property damage

EXPOSURE (E) –
How frequently is the employee exposed to the hazard?
3 = 50% to 100% of activity is exposed to hazard
2 = 10% to 49% of activity is exposed to hazard
1 = Less than 10% of activity is exposed to hazard.

Add the values of each component: **P + S + E = Total**

Example of a hazard rating chart:

P	Will occur if not controlled	3
S	Lost time injury	2
E	Employee exposed during 50% of activity	3
Total (transfer rating column on checklist)		8

HAZARD RATING:
(L) Low Hazard (requires monitoring) – Total of 3 or 4
(M) Moderate Hazard (requires attention) – Total of 5 or 6
(H) High Hazard (requires immediate attention) – Total of 7, 8 or 9

Date: _____
(YYYYMMDD)

Reviewed Date: October, 2013

Additional On-Site Hazard Assessment

Task: _____

Procedure: 1. _____

2. _____

3. _____

4. _____

5. _____

6. _____

Hazards: 1. _____

2. _____

3. _____

4. _____

5. _____

6. _____

7. _____

Controls: 1. _____

2. _____

3. _____

4. _____

5. _____

6. _____

7. _____

Additional Comments: _____

Signatures: _____

Have You Completed Your Hazard Assessment Today?

Hazard Assessment must be maintained at your immediate Administrative Office, and available for review upon request.

11.4 HAZARD ASSESSMENT WORKSHEET

(Copy provided to supervisor; OHS Committee/Representative and SHRM Unit)

Core Task:

Part A – Activities

Identify duties & activities associated with the core task to be performed.

Part B – Tools & Equipment

Use a checkmark to identify all tools & equipment to be used over the life of the project.

- Trucks, mini vans & vans (½ ton, ¾ ton, 1 ton, 1 ¼ ton, & 5 ton)
- Helicopter / Planes
- Forklift equipment
- All Terrain Vehicles (ATV's)
- Snowmobile
- Small open boats with motor
- Canoe
- Cargo nets
- Operate portable gasoline powered water pumps
- Fire Hoses
- Propane Stoves, white gas stove, fridges, freezers, and heaters
- Power Generators
- Backpack
- Operate spray equipment
- Welder
- Chop & Table Saws, Drills, Routers, Grinders etc.
- Powered Hand Tools – Air hammer, Drills, Air guns, Chainsaws
- Manual Hand Tools - Picks, shovels, , Axe, Sledge Hammers, etc.
- Landscaping equipment, lawnmowers, wheelbarrow, rake, etc.
- Cell phones, satellite phones portable (hand held)
- Rifles and shotguns
- Other _____

Part C -Task Specific Hazards/Working Conditions

Use a checkmark to identify all hazards associated with the duties and activities to be performed in Part A.

1. Chemical Hazard ~ Exposure to:

Pure Chemical Products

- Compressed Gases – (i.e., Propane)
- Flammable Liquids – (i.e., gasoline or white gas or kerosene)
- Combustible liquid or solids (i.e., diesel fuel, wood, cardboard, etc.)
- Toxic Liquids or Solids – (i.e., Pesticides)
- Poisonous Liquids or Solids -(i.e., Pesticides)
- Corrosive Liquids or Solids – (i.e., acid, base)
- Dangerously Reactive Materials

Decomposition Products

- Smoke (Burning products, fires)
- Carbon Monoxide (gas emissions)
- Nitrogen Dioxide (Diesel emissions)

2. Physical Hazards - Exposure to:

- Excessive Noise Levels
- Inadequate Lighting / Poor Visibility
- Temperature Extremes, (Frost bite and Hypothermia / Heat Stress/Heat Stroke)
- Radiation (UV Exposure – Sunlight / Radio waves / Microwaves / X-Rays)

3. Biological Hazards – Exposure to:

- Microbial agents (dead animals, bug bites, rusty metal, bird dropping/mold, etc.)

4. Potential Safety Hazards:

- Exposure to Cuts / Abrasions / Burns: Personnel exposed to sharp tools and objects, hot materials.
- Falls From Heights: Potential falls when working from heights (mounting/dismounting equipment, working from ladders/scaffolds, working on building roof).
- Slips /Trips/ Falls At Same Level: Slip/trip/falls due to poor housekeeping, rough and/or slippery terrain and surfaces (ice covered surfaces).
- Falls from Heights / different levels above 10 feet: Working from ladders, scaffolds, roofs, cliffs, etc.
- Falls into water / drowning: when working over/on/and adjacent to water: (offloading operations close to water, working from floating workstation, etc.).
- Electrical Hazards: Potential electrical shocks, burns, electrocution when working with power tools and electrical equipment and accessories.
- Crushing Injuries: Personnel caught between load and equipment.
- Pinch Point Injuries: Personnel getting body parts (fingers, hands, arms, body) caught in pinch points (manual handling, tools and equipment).
- Exposure to Pressurized materials and equipment: (compressed gas cylinders, high pressure hoses).
- Fires & Explosions: hydrogen gas explosion during forklift battery charging, hot work (welding, oxyacetylene cutting) around flammable and/or combustible materials; sparks, static discharge during confined space entry work.
- Confined Space Entry Hazards: Flammable/explosive gases, (leaking propane cylinders), toxic gases, (carbon monoxide), Oxygen deficient atmosphere.
- Manual Material Handling Hazards: Back injuries, hand, arm, shoulder injuries,

<p>strains and sprains.</p> <ul style="list-style-type: none"> <input type="checkbox"/> Exposure to dropped objects: Working under suspended loads, unsecured loads, improperly stored material at heights, dropped tools and equipment. <input type="checkbox"/> Flying particles / projectiles: Dust particles generated when using power tools, objects under stress <input type="checkbox"/> Mobile Equipment Collisions / Toppling Over: Equipment damage / worker injuries due to collisions, struck-by equipment, caught under equipment, etc. 	
<p>Part D – Personal Protective Equipment (PPE) and Controls Use a checkmark to identify all appropriate PPE & Controls necessary to protect personnel at the workplace.</p>	
<p>1. <u>Engineering Controls</u></p> <ul style="list-style-type: none"> <input type="checkbox"/> Barriers / Barricades <input type="checkbox"/> Machine Guards <input type="checkbox"/> Lighting <input type="checkbox"/> Safety Alarms <input type="checkbox"/> Gas Detection <input type="checkbox"/> Equipment Enclosure <input type="checkbox"/> Personnel Enclosure (Operators Cab) 	<p>2. <u>Administrative Controls</u></p> <ul style="list-style-type: none"> <input type="checkbox"/> Hazard Assessment Forms <input type="checkbox"/> Written Procedures (SWP's) <input type="checkbox"/> New Employee &/or Visitor Site Orientation <input type="checkbox"/> Training <input type="checkbox"/> Work Permits <input type="checkbox"/> Equipment & Inspections <input type="checkbox"/> Lockout (Padlock) <input type="checkbox"/> Tool-box meetings <input type="checkbox"/> Signs
<p>3. <u>PPE to Be Used Under Normal Operations</u></p> <ul style="list-style-type: none"> <input type="checkbox"/> Hardhat <input type="checkbox"/> Liner for Hardhat <input type="checkbox"/> Safety Boots <input type="checkbox"/> Coveralls/ Layered Clothing <input type="checkbox"/> Rip Stop Pant (for chain saw) <input type="checkbox"/> Reflective Safety Vest (High Visibility) <input type="checkbox"/> Ear Plugs &/or Muffs <input type="checkbox"/> Gloves <input type="checkbox"/> Safety Glasses and/or Goggles <input type="checkbox"/> Face Shield <input type="checkbox"/> Personal Floatation Device <input type="checkbox"/> Fall Arrest Harness & Lanyard 	<p>4. <u>PPE to be used under emergency conditions</u> (all checked items from #3 list plus following)</p> <ul style="list-style-type: none"> <input type="checkbox"/> Supplied Air Respirator or <input type="checkbox"/> SCBA (Self Contained Breathing Apparatus) <p>5. <u>Other Safety Equipment</u></p> <ul style="list-style-type: none"> <input type="checkbox"/> Cell Phone / Satellite Phone <input type="checkbox"/> First Aid Kit <input type="checkbox"/> Fire Extinguisher <input type="checkbox"/> Spill Response Materials
<p>Part E – Specialized Training Use a checkmark to identify any specialized training required.</p>	
<ul style="list-style-type: none"> <input type="checkbox"/> First Aid/CPR <input type="checkbox"/> Workplace Hazardous Materials Information System (WHMIS) <input type="checkbox"/> Transportation of Dangerous Goods (TDG) <input type="checkbox"/> Power Line Hazard Safety <input type="checkbox"/> Confined Space Entry <input type="checkbox"/> Working From Heights (Fall Protection) <input type="checkbox"/> Equipment Lockout & Tag-out <input type="checkbox"/> Certified Worker H&S Representative <input type="checkbox"/> Specialized Equipment Operation Training 	

<i>Part F – Safe Work Practices (SWPs)</i>	
<i>Based on the duties and activities identified and the associated hazards use a checkmark to identify the applicable SWPs required to mitigate the hazards. The SWPs are to be reviewed by all personnel, prior to conducting work and/or during the work (toolbox meetings)</i>	
<u><i>Health & Safety Procedures:</i></u>	<u><i>Tools & Equipment:</i></u>
<u><i>Personal Protection Equipment:</i></u>	<u><i>Process & Operations:</i></u>
<u><i>Emergency Equipment:</i></u>	<u><i>Mobile Equipment:</i></u>
<i>Hazard Analysis Completed By:</i>	
<i>Date:</i>	

APPENDIX 3

SAND BARREL ATTENUATION SYSTEM

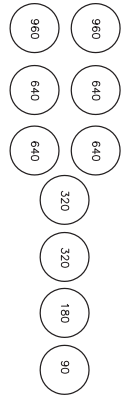

BARREL ARRAY - 80 km/h

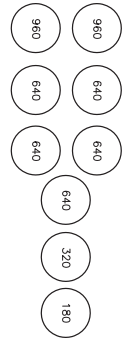

BARREL ARRAY - 70 km/h

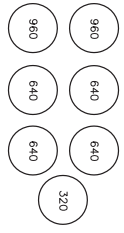

BARREL ARRAY - 60 km/h

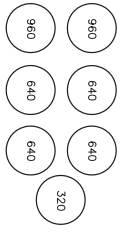

BARREL ARRAY - 50 km/h

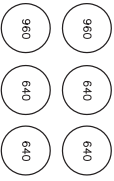

BARREL ARRAY - 40 km/h

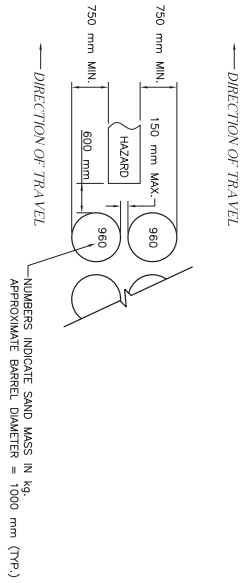

ONE DIRECTION TRAFFIC

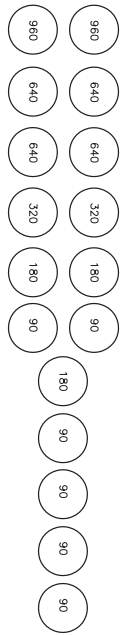

BARREL ARRAY - 110 km/h

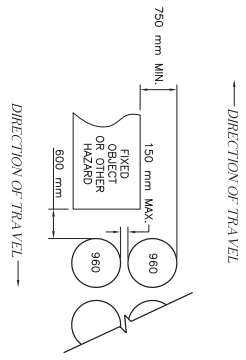

TWO DIRECTION TRAFFIC

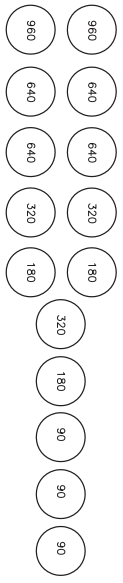

BARREL ARRAY - 100 km/h

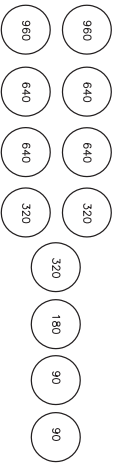

BARREL ARRAY - 90 km/h

NOTES

1. ONLY CRASH TESTED COMPONENTS MEETING NCHRP 350 REQUIREMENTS SHALL BE USED. THE SYSTEMS CURRENTLY AVAILABLE ARE:
 - a. ENERGIC INERTIA BARRIER SYSTEM BY QUIXOTE TRANSPORTATION SAFETY INC.
 - b. FITCH SAND BARREL SYSTEM BY QUIXOTE TRANSPORTATION SAFETY INC.
 - c. TRAFFIX IMPACT ATTENUATOR SAND BARRELS BY TRAFFIX DEVICES INC.
2. THE SAND MASS SHALL BE CLEARLY MARKED ON EACH BARREL.
3. FOR PERMANENT INSTALLATIONS, THE FITCH SYSTEM SHALL BE USED.
4. THE SYSTEMS SHALL BE INSTALLED STRICTLY IN ACCORDANCE WITH MANUFACTURER'S RECOMMENDATIONS.
5. THE SAND BARREL SYSTEMS ARE NON-DIRECTIONAL AND BREAK UP DURING IMPACT. IMPACT SHALL BE AVOIDED. IMPACT SHALL BE AVOIDED. IMPACT SHALL BE AVOIDED. ALLOWING FOR SAFE, STEADY DECELERATION OF SAND BARRELS FROM THE SYSTEM WILL SCATTER IN THE DIRECTION OF THE IMPACT.
6. FILL SAND SHALL CONFORM TO ASTM C-33 - WASHED CONCRETE SAND OR APPROVED EQUAL. INSURE CONTENT OF SAND SHALL BE NINE PERCENT OR LESS TO MINIMIZE CAKING. THE SAND SHALL BE MIXED WITH AN APPROPRIATE PERCENTAGE OF ROCK SALT WHEN USE DURING FREEZING TEMPERATURE IS EXPECTED.
7. BARRELS SHALL BE SET AS FAR FROM THE TRAVELED WAY AS POSSIBLE TO MINIMIZE THE NUMBER OF BRUSH OR NUISANCE HITS.
8. BARREL LAYOUT SHALL CONFORM WITH THE CONFIGURATION FOR THE APPROPRIATE POSTED HIGHWAY SPEED.
9. IN THE CASE OF WORK ZONE INSTALLATIONS, THE DESIGN SPEED SHALL BE AT LEAST EQUAL TO THE SPEED POSTED THROUGH THE WORK ZONE.

HIGHWAY DESIGN DIVISION							
DO NOT SCALE DRAWINGS							
Drawn By	Date	Scale	Datum	Dwg	Chk'd By	Designed By	Des. Chk'd By
x	Aug. 2014	Horiz. Vert.	x				
FOR USE BY TRAFFIC ENGINEERING ONLY							
Des. By		Date	Chk'd By		Date		
No.	By	REVISION DESCRIPTION		Date			



 TRANSPORTATION AND WORKS

 HIGHWAY DESIGN DIVISION

 Project No.

 Sheet No. 1 of 1

Project/Drawing Title

SAND BARREL CUSHION SYSTEM

APPENDIX 4

STANDARD BARRICADES FOR ROAD & BRIDGE CLOSURES

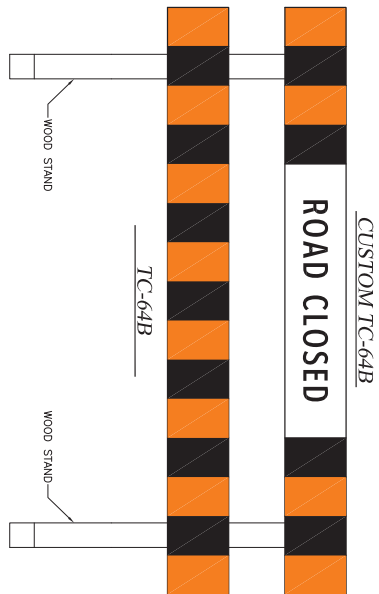
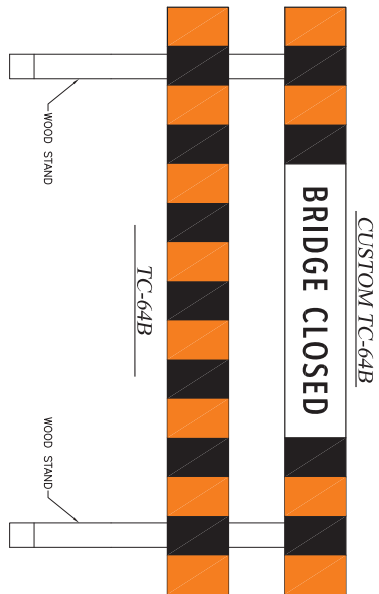

BRIDGE CLOSED AND ROAD CLOSED BOARDS MAY BE USED TO REPLACE ONE CONSTRUCTION BARRICADE TC-64B WHERE APPROPRIATE.
ALL DIMENSIONS ARE IN MILLIMETRES UNLESS OTHERWISE INDICATED.

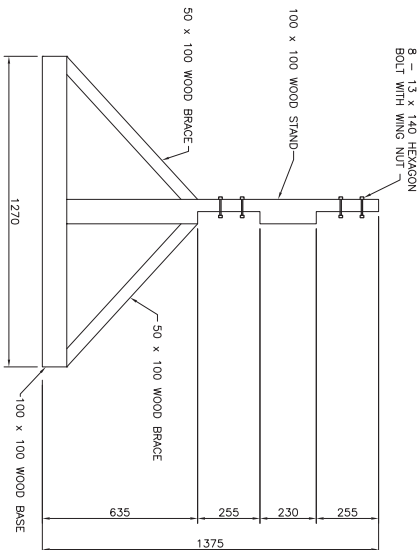

APPENDIX 5
NIGHT TIME OPERATIONS

APPENDIX 5: Night Time Operations

Additional consideration shall be given to night time operations which is the time period between one half hour after sunset and one half hour before sunrise. The guidelines for night time operations followed widely in North America were developed by the US Transportation Research Board under the National Cooperative Highway Research Program which are communicated in NCHRP Reports 498 and 726. These guidelines set illumination levels and best practices for the safety of the workers and the direction of traffic so that all traffic control devices and workers are clearly visible during hours of darkness.

Minimum retro-reflectivity standards for all traffic control devices and personal protective equipment are set to allow for adequate visibility at night, however, additional warning devices may be used to enhance visibility where appropriate.

Illumination Requirements

Illumination is required for all night time work. Lighting devices shall be installed so they are oriented between 45 and 90 degrees away from the flow of traffic. Lights should never be aimed or spill over into oncoming traffic.

Luminaires for night work shall be of sufficient wattage and quantity to provide horizontal illuminance as specified in the following table.

Illuminance Level	Minimum Average Illuminance (Lux)	Minimum Point Illuminance (Lux)
1	54	30
2	108	80
3	216	N/A

A minimum of Level 1 illuminance is required to be provided on any portion of the Work Zone/Area where workers are present. Traffic Control Persons used in night time operations are required to be illuminated from above with a minimum of Level 3 illuminance.

Minimum illuminance requirements for other operations are as follows:

Paving Operations:

Level 2 illuminance is required 15 m ahead of the paver/MTV and 30 m behind the paver.
Level 1 illuminance is required 120 m ahead to 250m behind the paver.

Milling Operations:

Level 2 illuminance is required 15 m ahead and 15 m behind the milling machine.
Level 1 illuminance is required 120 m ahead to 250m behind the milling machine.

Measurement of illuminance shall be taken at the road surface, in a uniform pattern spaced at 5 meter intervals throughout a representative test area. The contractor shall check illumination levels in the Work Zone/Area each time a change in lighting is made and at least once during each period of night time operations.

The following additional safety tasks/requirements shall be carried out whenever work is carried out at night:

- All traffic control devices shall be inspected during darkness to ensure they are visible;
- All workers and Traffic Control Persons (TCPs) working at night are required to wear white or light coloured coveralls under safety vests. TCPs must carry a flashlight with a semi-transparent red cone. If TCPs use two-way radios at night they are required to be equipped with voice activated microphones so that the flashlight is in a free hand;
- Hard Hats must be worn by all workers and have at least 80 cm² of reflective material visible from all sides and from approaching drivers; and
- Ensure illumination meets the set requirements for the equipment used and task.

APPENDIX 6

DECISION MATRIX FOR SIGN LAYOUT SELECTION

TRAFFIC CONTROL MANUAL 2018

TO LOCATE THE APPROPRIATE TYPICAL LAYOUT (FIGURES 750 TO 799), USE THE FOLLOWING PROCESS ON THE DECISIONMATRIX IN TABLE BELOW.

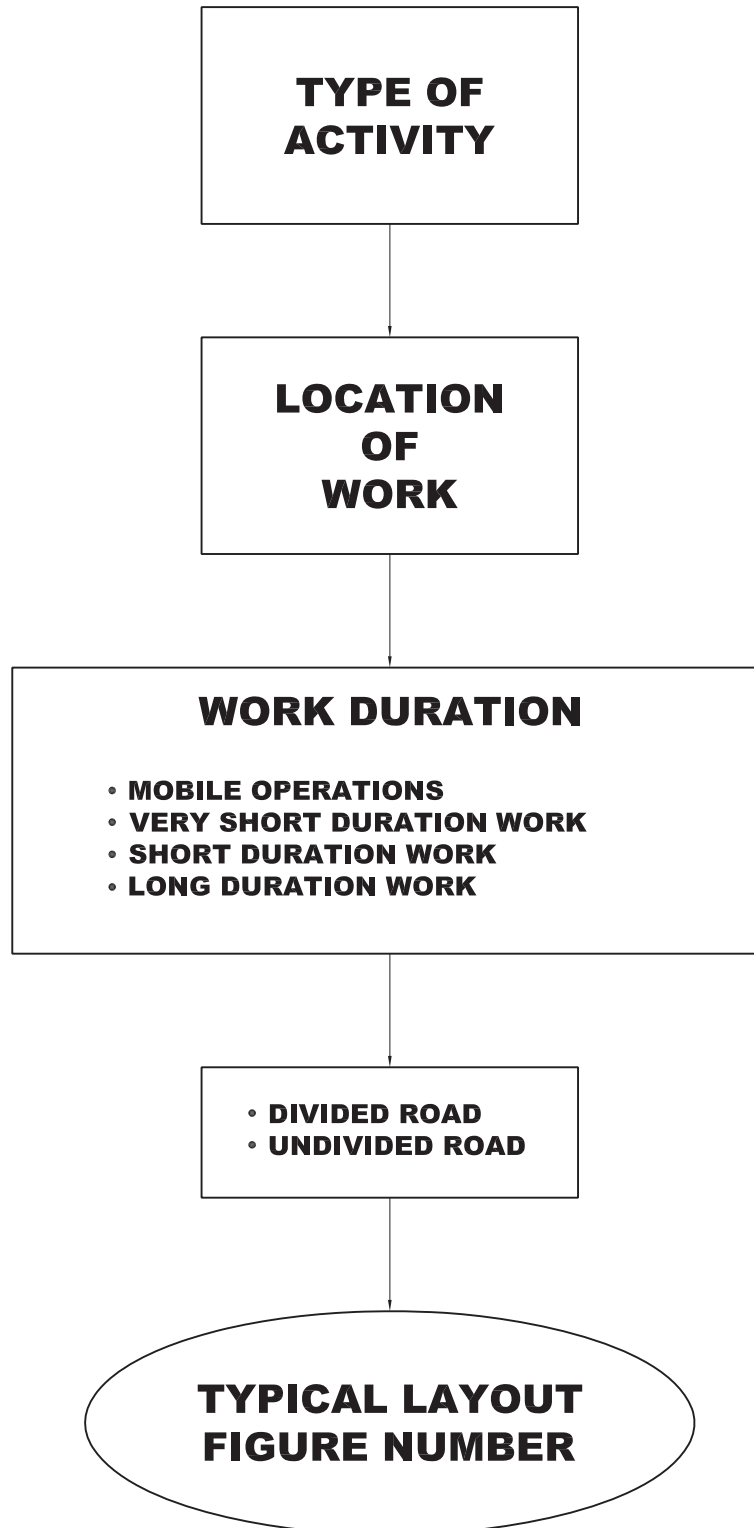

General Traffic Control Signage Information

Activity		Work Location		Work Duration		Traffic/Speed		Figure
Typical Advanced Warning & Approach Signage on Construction Projects with Flagperson Lane Control	→	All	→	All	→	All	→	740-1
Typical Advanced Warning & Approach Signage on Construction Projects without Lane Control	→	All	→	All	→	All	→	740-2
Typical Advanced Warning & Approach Signage on Maintenance Projects with Flagperson Lane Control	→	All	→	All	→	All	→	740-3
Typical Advanced Warning & Approach Signage on Maintenance Projects without Lane Control	→	All	→	All	→	All	→	740-4
Intersecting Roads in Work Area	→	All	→	Long Term	→	> 60km/h	→	756-1
						≤ 60km/h	→	756-2
Positioning of Flagperson	→	All	→	All	→	All	→	757-1
Positioning of Flagperson on Hill	→	All	→	All	→	All	→	757-2
Pavement Drop Off	→	All	→	All	→	All	→	758-1
Truck Entrance	→	All	→	All	→	All	→	759-1
Truck Entrance W/ Flagperson	→	All	→	All	→	> 60km/h	→	759-1F
Portable Sign Supports	→	All	→	All	→	All	→	790-1
Timing of Portable Traffic Lights	→	All	→	All	→	All	→	791-1
Construction Distance Table	→	All	→	All	→	All	→	799-1
Legend	→	All	→	All	→	All	→	799-2

General Layouts – Two Lane Road

Activity		Work Location		Work Duration		Traffic/Speed		Figure
Work Adjacent to Roadway	→	Right Shoulder	→	Mobile Operations	→	All	→	750-2
			→	Very Short Term	→	All	→	750-2
			→	Short Term	→	All	→	750-1
			→	Long Term	→	All	→	750-1
Work at Edge of Roadway - Partial Lane Closure	→	Encroachment in Right Lane	→	Mobile Operations	→	All	→	751-3
			→	Very Short Term	→	All	→	751-2
			→	Short Term	→	All	→	751-2
			→	Long Term	→	All	→	751-1
One Lane Closed - Flagperson	→	Right Lane	→	All	→	> 60km/h	→	752-1
					→	≤ 60km/h	→	752-2
One Lane Closed - Slow Moving Operations	→	Right Lane	→	All	→	All	→	752-3
One Lane Closed - Portable Traffic Lights	→	Right Lane	→	Short Term	→	All	→	752-4
			→	Long Term	→	All	→	752-4
One Lane Closed - Yield to Oncoming Traffic	→	Right Lane	→	Very Short Term	→	Low Volume	→	752-5
			→	Short Term	→	Low Volume	→	752-5
			→	Long Term	→	Low Volume	→	752-5
One Lane Closed - Single Automated Flagging Device	→	Right Lane	→	All	→	≤ 60km/h	→	792-1
					→	> 60km/h	→	792-2
One Lane Closed - Dual Automated Flagging Device	→	Right Lane	→	All	→	≤ 60km/h	→	792-3
					→	> 60km/h	→	792-4
One Lane Closed - Successive Work Areas	→	Right Lane	→	All	→	All	→	753-1
One Lane Closed - Successive Work Areas, Slow Moving Operations	→	Right Lane	→	All	→	All	→	753-2
Roadside Diversion - Two Lanes Closed	→	Roadway	→	Short Term	→	All	→	754-1
			→	Long Term	→	All	→	754-1
Detour - Road Closure	→	Roadway	→	Short Term	→	All	→	755-1
			→	Long Term	→	All	→	755-2
Intersection - Lane Closed Near Side	→	Right Lane	→	All	→	All	→	756-3
Intersection - Lane Closed Far Side	→	Right Lane	→	All	→	All	→	756-4
Grading Operations	→	Right Lane	→	All	→	All	→	775-1
Road Closed	→	Roadway	→	All	→	All	→	776-1
Road Closed At T-Intersection	→	Roadway	→	All	→	All	→	776-2
Road Closed W/ Flagperson	→	Roadway	→	Very Short Term	→	All	→	776-3
			→	Short Term	→	All	→	776-3

General Layouts – Multi-Lane Road Undivided

Activity	Work Location	Work Duration	Traffic/Speed	Figure
Work Adjacent to Roadway	→ Right Shoulder	→ Mobile Operations →	All →	750-4
		→ Very Short Term →	All →	750-4
		→ Short Term →	All →	750-3
		→ Long Term →	All →	750-3
Work at Edge of Roadway - Partial Lane Closure	→ Encroachment in Right Lane	→ Mobile Operations →	All →	751-7
		→ Very Short Term →	All →	751-8
		→ Short Term →	All →	751-8
		→ Long Term →	All →	751-9
Lane Closure - Four Lane Road	→ Left Lane	→ Mobile Operations →	All →	752-8
		→ Very Short Term →	All →	752-11
		→ Short Term →	All →	752-7
		→ Long Term →	All →	752-7
	→ Right Lane	→ Mobile Operations →	All →	752-8
		→ Very Short Term →	All →	752-13
		→ Short Term →	All →	752-16
		→ Long Term →	All →	752-16
Lane Closure - Five Lane Road	→ Left Lane	→ Mobile Operations →	All →	752-8
		→ Very Short Term →	All →	752-18
		→ Short Term →	All →	752-18
		→ Long Term →	All →	752-18
	→ Center Lane - Two-Way Turn Lane	→ Mobile Operations →	All →	752-8
		→ Very Short Term →	All →	752-19
		→ Short Term →	All →	752-19
		→ Long Term →	All →	752-19
	→ Right Lane	→ Mobile Operations →	All →	752-8
		→ Very Short Term →	All →	752-13
		→ Short Term →	All →	752-16
		→ Long Term →	All →	752-16
Lane Closure w/ Crash Attenuators	→ Left Lane	→ Mobile Operations →	All →	752-34
		→ Very Short Term →	All →	752-35
	→ Right Lane	→ Mobile Operations →	All →	752-34
		→ Very Short Term →	All →	752-36
		→ Short Term →	All →	752-37
		→ Long Term →	All →	752-37
Two Lanes Closed - Four Lane Road	→ Right Lanes	→ Very Short Term →	All →	752-20
		→ Short Term →	All →	752-20
		→ Long Term →	All →	752-20

Continued on next page

General Layouts – Multi-Lane Road Undivided

Activity		Work Location		Work Duration		Traffic/Speed		Figure
Two Lanes Closed - Five Lane Road	→	Right Lanes	→	Very Short Term	→	All	→	752-21
			→	Short Term	→	All	→	752-21
			→	Long Term	→	All	→	752-21
Two Lanes Closed - Five Lane Road	→	Center Lane & Left Lane	→	Very Short Term	→	All	→	752-22
			→	Short Term	→	All	→	752-22
			→	Long Term	→	All	→	752-22
Exit Lane / Ramp Closure	→	Right Lane	→	Very Short Term	→	All	→	752-23
			→	Short Term	→	All	→	752-23
			→	Long Term	→	All	→	752-24
Partial Exit Lane / Ramp Closure	→	Right Lane	→	Very Short Term	→	All	→	752-25
			→	Short Term	→	All	→	752-25
			→	Long Term	→	All	→	752-25
Partial Entrance Lane / Ramp Closure	→	Right Lane	→	Very Short Term	→	All	→	752-26
			→	Short Term	→	All	→	752-26
			→	Long Term	→	All	→	752-26
Climbing Lane Closed	→	Right Lane	→	Short Term	→	≤ 60km/h	→	752-27
			→	Long Term	→	≤ 60km/h	→	752-27
Center Climbing Lane Closed	→	Center/Left Lane	→	Short Term	→	≤ 60km/h	→	752-28
			→	Long Term	→	≤ 60km/h	→	752-28
Lane Closure Opposite Climbing Lane	→	Left Lane	→	Short Term	→	≤ 60km/h	→	752-29
			→	Long Term	→	≤ 60km/h	→	752-29
Roadside Diversion - Two Lanes Closed	→	Roadway	→	Short Term	→	All	→	754-2 & 3
			→	Long Term	→	All	→	754-2 & 3
Lane Realignment	→	Roadway	→	Short Term	→	All	→	755-3
			→	Long Term	→	All	→	755-3

General Layouts – Multi-Lane Divided Highway

Activity	Work Location	Work Duration	Traffic/Speed	Figure
Work Adjacent to Roadway	→ Right Shoulder	→ Mobile Operations →	All →	750-5
		→ Very Short Term →	All →	750-5
		→ Short Term →	All →	750-3
		→ Long Term →	All →	750-3
	→ Left Shoulder	→ Mobile Operations →	All →	750-6
		→ Very Short Term →	All →	750-6
		→ Short Term →	All →	750-7
		→ Long Term →	All →	750-7
Work in Median	→ Median	→ Mobile Operations →	All →	750-8
		→ Very Short Term →	All →	750-9
		→ Short Term →	All →	750-9
		→ Long Term →	All →	750-9
Work at Edge of Roadway - Partial Lane Closure	→ Encroachment in Left Lane	→ Mobile Operations →	All →	751-4
		→ Very Short Term →	All →	751-5
		→ Short Term →	All →	751-5
		→ Long Term →	All →	751-6
	→ Encroachment in Right Lane	→ Mobile Operations →	All →	751-7
		→ Very Short Term →	All →	751-8
		→ Short Term →	All →	751-8
		→ Long Term →	All →	751-9
One Lane Closed - Flagperson	→ Right Lane	→ Very Short Term →	All →	752-6
		→ Short Term →	All →	752-6
Lane Closure	→ Left Lane	→ Mobile Operations →	All →	752-9
		→ Very Short Term →	< 70km/h →	752-10
		→ Short Term →	All →	752-12
		→ Long Term →	All →	752-17
	→ Right Lane	→ Mobile Operations →	All →	752-9
		→ Very Short Term →	All →	752-14
		→ Short Term →	All →	752-15
		→ Long Term →	All →	752-15
Lane Closure w/ Crash Attenuators	→ Left Lane	→ Very Short Term →	All →	752-30
		→ Short Term →	All →	752-32
		→ Long Term →	All →	752-32
	→ Right Lane	→ Very Short Term →	All →	752-31
		→ Short Term →	All →	752-33
		→ Long Term →	All →	752-33

Continued on next page

General Layouts – Multi-Lane Divided Highway

Activity		Work Location		Work Duration		Traffic/Speed		Figure
Lane Closure - Zipper Merge	→	Right Lane	→	All	→	All	→	793
Exit Lane / Ramp Closure	→	Right Lane	→	Very Short Term	→	All	→	752-23
			→	Short Term	→	All	→	752-23
			→	Long Term	→	All	→	752-24
Partial Exit Lane / Ramp Closure	→	Right Lane	→	Very Short Term	→	All	→	752-25
			→	Short Term	→	All	→	752-25
			→	Long Term	→	All	→	752-25
Partial Entrance Lane / Ramp Closure	→	Right Lane	→	Very Short Term	→	All	→	752-26
			→	Short Term	→	All	→	752-26
			→	Long Term	→	All	→	752-26
Road Closed W/ Flagperson	→	Roadway	→	Very Short Term	→	All	→	776-4
			→	Short Term	→	All	→	776-4

Special Activity Layouts

Activity - Line Painting		Work Location		Work Duration		Traffic/Speed		Figure
Line Painting Procedures	→	Roadway	→	All	→	All	→	771-1
Temporary Striping	→	Roadway	→	All	→	All	→	770-1
Painting Center Cross Hatching	→	Roadway	→	All	→	≥ 60km/h	→	771-2
					→	< 60km/h	→	771-7
Painting Center Cross Hatching W/ Flagperson	→	Roadway	→	All	→	≥ 60km/h	→	771-2F
					→	< 60km/h	→	771-7F
Painting Center Cross Hatching - Multiple Lanes	→	Roadway	→	All	→	All	→	771-12F
Painting in Through Lane	→	Left Side	→	All	→	≥ 60km/h	→	771-3
					→	< 60km/h	→	771-8
	→	Right Side	→	All	→	< 60km/h	→	771-8A
Painting in Through Lane W/ Flagperson	→	Left Side	→	All	→	≥ 60km/h	→	771-3F
					→	< 60km/h	→	771-8F
	→	Right Side	→	All	→	≥ 60km/h	→	771-3AF
					→	< 60km/h	→	771-8AF
Arrows, Stop Bars & Islands	→	Left Side	→	All	→	≥ 60km/h	→	771-4
					→	< 60km/h	→	771-9
	→	Right Side	→	All	→	≥ 60km/h	→	771-4A
					→	< 60km/h	→	771-9A
Arrows, Stop Bars & Islands W/ Flagperson	→	Left Side	→	All	→	≥ 60km/h	→	771-4F
					→	< 60km/h	→	771-9F
	→	Right Side	→	All	→	≥ 60km/h	→	771-4AF
					→	< 60km/h	→	771-9AF
Arrows, Stop Bars & Islands - Multiple Lanes	→	Left Side	→	All	→	All	→	771-13F
	→	Right Side	→	All	→	All	→	771-13AF
Arrows, Stop Bars, Islands & Crosswalks	→	Roadway	→	All	→	< 60km/h	→	771-17F
Ramp Painting	→	Roadway	→	All	→	All	→	771-5
Ramp Painting W/ Flagperson	→	Roadway	→	All	→	All	→	771-5F
Painting Words/Symbols	→	Left Lane	→	All	→	All	→	771-6
Trageting / Dotting - Two Way Traffic	→	Roadway	→	All	→	All	→	771-10
Trageting / Dotting - Divided Highway	→	Roadway	→	All	→	All	→	771-11
Intersecting Roadways	→	Roadway	→	All	→	All	→	771-14F
Lane Markings - Rapid Moving	→	Roadway	→	All	→	All	→	771-15
Activity - Surveying								
		Work Location		Work Duration		Traffic/Speed		Figure
Survey Crew - Two Way Traffic	→	Roadway	→	All	→	All	→	780-1
Survey Crew - Divided Highway	→	Roadway	→	All	→	All	→	780-2
Survey Crew - Adjacent To Roadway	→	Shoulder Work	→	All	→	All	→	780-3